



Airports Commission: Final Report

July 2015

The Airports Commission has actively considered the needs of blind and partially sighted people in accessing this document. The text will be made available in full on the Commission's website. The text may be freely downloaded and translated by individuals or organisations for conversion into other accessible formats. If you have other needs in this regard please contact:

Airports Commission
6th Floor Sanctuary Buildings
Great Smith Street
London
SW1P 3BT

General email enquiries: airports.enquiries@airports.gsi.gov.uk

© Crown copyright 2015

Copyright in the typographical arrangement rests with the Crown.

You may re-use this information (not including logos or third-party material) free of charge in any format or medium, under the terms of the Open Government Licence. To view this licence, visit www.nationalarchives.gov.uk/doc/open-government-licence/ or write to the Information Policy Team, The National Archives, Kew, London TW9 4DU, or e-mail: psi@nationalarchives.gsi.gov.uk.

Where we have identified any third-party copyright information you will need to obtain permission from the copyright holders concerned.

ISBN: 978-1-84864-158-7

Contents

Chair’s Foreword	3
Acknowledgements	6
Short-listed scheme descriptors	7
Executive Summary	9
Chapter 1. Introduction	37
Chapter 2. The global and national aviation context for the Commission’s work	45
Chapter 3. The Case for Change	69
Chapter 4. The Commission’s Appraisal and Consultation Process	89
Chapter 5. The Short-listed Schemes	97
Chapter 6. Strategic Fit Assessment	105
Chapter 7. Economic Impacts Assessment	135
Chapter 8. Surface Access Assessment	151
Chapter 9. Environment Assessment	167
Chapter 10. People Assessment	213
Chapter 11. Commercial Viability and Delivery	221
Chapter 12. Operational Viability Assessment	237
Chapter 13. Recommended Option for Expansion	245
Chapter 14. Respecting the Needs of Local Communities	275
Chapter 15. Supporting Growth and Connectivity Across the UK	311
Chapter 16. Next Steps	319
Annex A – The Commission’s Expert Advisory Panel	341

Foreword



The London airport capacity problem has perplexed governments for over fifty years, for reasons that are not hard to find. The considerable benefits of aviation accrue to the many, while the environmental costs are borne by the (relatively) few. For those who live near them airports are noisy neighbours and are greedy for space. In a congested corner of a crowded island it is not easy to find a good home for them. No new full-length runway has been laid down in the South East of England since the 1940s. But other developed and developing countries face similar issues and have nonetheless been better able to provide infrastructure to keep pace with the growing demands of an expanding aviation market.

The independent Airports Commission was set up in late 2012 with a brief to find an effective and deliverable solution, and to make recommendations which will allow the UK to maintain its position as Europe's most important aviation hub. We believe we have now identified a solution which can command widespread support.

Over the last two and a half years we have reviewed the evidence afresh, without preconceptions, and consulted widely. The approach we took was inclusive and integrated. So the *Final Report* covers developments in the aviation sector in some depth, but sets them within a broader economic and environmental context. In assessing the case for expansion in particular locations the Commission has examined its implications across a wide range of factors including noise, surface transport, employment, air quality, housing and local communities.

At the end of this extensive work programme our conclusions are clear and unanimous.

While London remains a well-connected city its airports are showing unambiguous signs of strain. Heathrow is operating at capacity, and Gatwick is quickly approaching the same point. There is still spare capacity elsewhere in the South East for point-to-point and especially low-cost flights, but with no availability at its main hub airport London is beginning to find that new routes to important long-haul destinations are set up elsewhere in Europe rather than in the UK. Other UK airports are increasingly squeezed out of Heathrow, with passengers from the nations and regions obliged to transfer through other European airports, or Middle Eastern hubs. That costs them time and money, and is off-putting to inward investors. Without action soon the position will continue to deteriorate, and the entire London system will be full by 2040.

Good aviation connectivity is vital for the UK economy. It promotes trade and inward investment, and is especially crucial for a global city like London. The service sector, whether the City, the media industry or universities, depends heavily on prompt face-to-face contact. There is strong evidence that good transport links, and especially aviation connectivity, make an important contribution to enhancing productivity, which is an important national challenge.

So a new runway in the South East is needed by 2030, which means a firm decision is needed soon, as bringing it into operation will take a decade or more. One new runway, even fully utilised, is compatible with continued progress towards reducing carbon emissions, and putting it elsewhere in the country would produce a far less efficient outcome. It will provide the capacity we need until 2040 at least. Beyond that, the position is uncertain, and will be strongly dependent on the international policy approach to climate change.

We have concluded that the best answer is to expand Heathrow's runway capacity. A brand new airport in the Thames Estuary, while appealing in theory, is unfeasibly expensive, highly problematic in environmental terms and would be hugely disruptive for many businesses and communities. Gatwick, by contrast, has presented a plausible case for expansion. It is well placed to cater for growth in intra-European leisure flying, but is unlikely to provide as much of the type of capacity which is most urgently required: long-haul destinations in new markets. Heathrow can provide that capacity most easily and quickly. The benefits are significantly greater, for business passengers, freight operators and the broader economy. All passengers will benefit from enhanced competition.

Our choice at Heathrow is in favour of the Northwest Runway proposal by the airport operator. The so-called Heathrow Hub is an imaginative idea, which has usefully opened up thinking about the way the airport operates, but for the reasons we explain is less attractive from a noise perspective. The Northwest Runway scheme is technically feasible and does not involve massive, untested infrastructure. The costs are high, but financeable by the private sector, in our judgement and that of investors.

Heathrow expansion has of course been recommended before, and subsequently set aside in the face of local opposition. To make expansion possible the Commission recommends a comprehensive package of accompanying measures which would make the airport's expansion more acceptable to its local community, and to Londoners generally. The package includes a ban on night flights, more reliable respite for overflowed communities, a legally-enforced "noise envelope", a statutory independent aviation noise authority, and a noise levy to fund a far stronger and more generous set of compensation and mitigation schemes. New measures to ensure acceptable air quality around the airport will also be

needed. All this would be accompanied by a new Community Engagement Board based on the successful model adopted in Amsterdam.

Furthermore, as there is no environmental or operational case for a fourth runway at Heathrow, that should be ruled out by government through legislation firmly and finally.

Combined with improvements to aircraft technology, which are reducing noise and emissions over time, and new traffic management procedures, all this means that an expanded Heathrow would be a better neighbour for local communities than the airport is today. A bigger Heathrow would not inflict noise nuisance on more people than the airport does today, and the people affected would be far better compensated. Expansion and the mitigation of the airport's local impacts go hand in hand, as the former can provide the financial resources needed for the latter.

The Commission urges the Government to make an early decision on its recommendations. Further delay will be increasingly costly and will be seen, nationally and internationally, as a sign that the UK is unwilling or unable to take the steps needed to maintain its position as a well-connected open trading economy in the twenty first century.

I am very grateful to my Commission colleagues John Armitt, Ricky Burdett, Vivienne Cox and Julia King for their support. They have devoted far more time and energy to the project than they expected, and on an entirely voluntary basis. The work has benefited hugely from their different skills and perspectives. I would also like to recognise the contribution made by Geoff Muirhead before his resignation in September 2013. Phil Graham, our excellent Secretary, has led a dedicated and hard-working team with great skill and tact. All those who contributed to the work are listed in the Acknowledgements section: I thank them all.

Finally, however, it is also important to thank the many thousands of individuals and organisations who have responded, often on a voluntary basis, to our discussion papers and consultations, participated in our public events or taken the time to meet the Commission and explain their views. Their input has been a crucial element of the Commission's process and has had a significant impact on the findings in this *Final Report*.

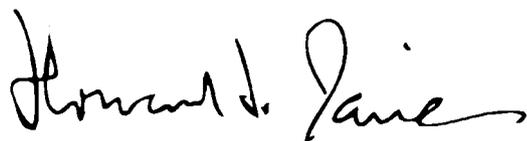
A handwritten signature in black ink, reading "Howard Davies". The signature is written in a cursive, flowing style with a long, sweeping tail on the final letter.

Howard Davies

Acknowledgements

The Commission would like to thank the following for their significant and valuable contribution to its work since its formation in 2012:

All of those who have worked in the Airports Commission Secretariat in the course of the Commission's process: Doris Alakija, Sophie Bell, Sarah Bishop, Michelle Cakebread, Roy Calcutt, Rob Cashmore, Aon Chau, Phil Cotterell, Daniel Cox, Lorna Dennis, Antonia Dineen, Victoria Edmonds, Jagoda Egeland, David Elvy, Michael Fox, Daniel Frampton, Jon Franklin, Oliver Fryatt, Philip Graham, Katy Grundy, Stephen Howe, Fiona James, Sophie Keay, Aastha Mantri, Oliver Mulvey, Jonne Olkinuora, Sarah Perring, Ed Pertwee, Eirik Pitkethly, Damien Reeves, Helen Round, Jonathan Saks, Paul Smale, Charles Small, David Smith, Matt Sowter, Jillian Spindura, Alex Szyjanowicz, Ali Torabi, Stuart Voller, David Williams and Brian Zackon;

The members of the Commission's Expert Advisory Panel, as listed at Annex A to this *Final Report*;

The staff of the Department for Transport including in particular for their contribution to the Commission's modelling and forecasting work;

The Civil Aviation Authority, Network Rail, Highways England, International Transport Forum and Committee on Climate Change for their input in preparation for and advice during the Commission's consultation processes;

The Sustainability Reference Group, comprising Defra, DECC, Cabinet Office, DCLG, DCMS, Natural England, the Environment Agency and English Heritage, for their input in preparing the draft *Appraisal Framework*; and

The International Transport Forum and the OECD for organising an expert roundtable on Expanding Airport Capacity Under Constraints in Large Urban Areas.

Short-listed scheme descriptors

The following terms and acronyms are used throughout the Final Report to reference the three short-listed schemes and their promoters:

- Gatwick Airport Ltd (GAL) is the promoter for the Gatwick Second Runway scheme (LGW-2R). The proposal is for a new full length runway to the south of and parallel to the existing runway at Gatwick Airport.
- Heathrow Airport Ltd (HAL) is the promoter for the Heathrow Northwest Runway scheme (LHR – NWR). The proposal is for a new full length runway to the northwest of the current northern runway at Heathrow Airport.
- Heathrow Hub Ltd (HHL) is the promoter for the Heathrow Extended Northern Runway scheme (LHR – ENR). The proposal is for an extension of the existing northern runway at Heathrow Airport to the west.

Executive Summary

The position of the UK within the global aviation market is critical to its economy: it is central to ensuring increased productivity, growth and employment opportunities. The Airports Commission's terms of reference require it to propose measures to maintain the UK's status as global hub for aviation. Delivering new capacity by 2030 will be crucial to that objective.

The Airports Commission short-listed three options for this new capacity: one new northwest runway at Heathrow Airport; a westerly extension of the northern runway at Heathrow Airport; and one new runway at Gatwick Airport. It conducted a robust, integrated and transparent process to assess these options, considering a range of economic, social and environmental factors and engaging extensively with interested parties through formal consultation, public evidence sessions and a programme of meetings and visits.

Each of the three schemes shortlisted was considered a credible option for expansion, capable of delivering valuable enhancements to the UK's aviation capacity and connectivity. Each would also have environmental impacts, which would need to be carefully managed.

The Commission has nonetheless unanimously concluded that the proposal for a new Northwest Runway at Heathrow Airport, in combination with a significant package of measures to address its environmental and community impacts (see box below), presents the strongest case.

A Balanced Approach to Expansion

Expanding Heathrow provides a unique opportunity to change the way the airport operates. The additional income generated as a result of operating a third runway should be allocated in a new way, and the airport should be obliged to develop a better and more collaborative relationship with its local communities, as some overseas airports have done.

The Commission therefore recommends that a number of measures should be taken forward, in parallel with the approval, construction and operation of any new capacity at Heathrow, to address its impacts on the local environment and communities:

- *Following construction of a third runway at the airport there should be **a ban on all scheduled night flights** in the period 11:30pm to 6:00am. This is only possible with expansion.*
- *A clear **'noise envelope'** should be agreed and Heathrow Airport must be legally bound to stay within these limits. This could include stipulating no overall increase above current levels.*
- *A third runway should allow periods of **predictable respite to be more reliably maintained**.*
- *Heathrow Airport Ltd should compensate those who would lose their homes **at full market value plus an additional 25% and reasonable costs**. It should make this offer available as soon as possible.*
- *Heathrow Airport Ltd should be held to its commitment to spend **more than £1 billion on community compensation**. In addition, **a new aviation noise charge or levy** should be introduced to insure that airport users pay more to compensate local communities. Taken together these would fund enhanced noise insulation and other schemes. Support for schools should be included as a priority.*
- *A **Community Engagement Board** should be established under an independent Chair, with real influence over spending on compensation and community support and over the airport's operations.*
- *An **independent aviation noise authority** should be established with a statutory right to be consulted on flight paths and other operating procedures.*

- **Training opportunities and apprenticeships for local people** should be provided so that nearby communities benefit from jobs generated by the new infrastructure.
- **A major shift in mode-share** for those working at and arriving at the airport should be incentivised, through measures including new rail investments and a continuing focus on employee behaviour change. A congestion or access charge for motor vehicles should also be considered.
- **Additional operations at an expanded Heathrow must be contingent on acceptable performance on air quality.** New capacity should only be released when it is clear that air quality at sites around the airport will not delay compliance with EU limits.
- **A fourth runway should be firmly ruled out.** The government should make a commitment in Parliament not to expand the airport further. There is no sound operational or environmental case for a four runway Heathrow.

A new Northwest Runway at Heathrow delivers more substantial economic and strategic benefits than any of the other shortlisted options, strengthening connectivity for passengers and freight users and boosting the productivity of the UK economy. It strikes a fair balance between national and local priorities. And it is the most likely route to achieving the Commission's terms of reference.

This is a fundamentally different proposition from previous proposals to expand at Heathrow. It delivers a full-length runway, maximising the connectivity gain. It is situated further west than the current runways, which will reduce the number of people affected by noise. And it would be accompanied by strong measures to limit the impacts on those living nearby.

Taken together, these recommendations ensure that an expanded Heathrow can be a better neighbour for local communities than the airport is today, while delivering significantly enhanced connectivity and substantial long-term economic and strategic benefits for the UK as a whole. The Commission recommends that the Government should support the delivery of this plan in its entirety.

The Airports Commission

Decisions on airport location and capacity are among the most important strategic choices a country or city can make; and among the most contentious.

That is why, in September 2012, the Government asked Howard Davies to chair an independent Commission to identify and recommend options to maintain the UK's position as Europe's most important aviation hub. In addition to the Chair, the members of the Commission are Sir John Armit, Professor Ricky Burdett, Vivienne Cox and Professor Dame Julia King.¹

The Commission was tasked with producing:

- An Interim Report, published at the end of 2013, setting out the nature, scale and timing of steps needed to maintain the UK's global hub status alongside recommendations for making better use of the UK's existing runway capacity over the next five years; and
- A Final Report (this document) by summer 2015 setting out recommendations on how to meet any need for additional airport capacity in the longer term.

The Commission has followed an approach that is:

- **Integrated:** considering a range of economic, social and environmental factors that affect how much – and what sort of – airport capacity is needed in the UK; and
- **Open, transparent and collaborative:** engaging extensively with a broad range of interested parties through formal consultation, public evidence sessions, a programme of meetings and visits and a series of discussion papers on key topics.

This approach has contributed significantly to making the recommendations in this *Final Report* robust and deliverable.

The global aviation context

Globalisation and technological innovation are driving an increase in cross-border flows of goods, services and people; and the global economy's centre of gravity is shifting from west to east. Lifestyles have changed, with many people taking advantage of European and wider integration to live and work outside their country of origin. Global passenger demand for air travel has been on an upward trend since the middle of the 20th century and has grown particularly strongly since the 1970s. And the environment and climate change are increasingly important elements of the international political context.

Aviation is in a dynamic and constant state of evolution as airlines find new ways of adapting their businesses to respond to these changes, with two main paths of development being seen over the past two decades – one of consolidation, partnership and network integration; the other one of new entrants and expanding point-to-point travel.

¹ A sixth member of the Commission, Geoff Muirhead, resigned in September 2013.

The consolidation of the airline industry and the associated rise of alliances has resulted in the expansion of ‘hub-and-spoke’ networks run by major carriers at the world’s largest airports. In these networks, airlines and alliances route their traffic through one or more focal airports (‘hubs’), with feeder traffic from other airports in the network (‘spokes’) supplementing local origin and destination traffic. For passengers, the hub-and-spoke model maximises the choice of direct destinations at the hub airport and offers potential to travel to a very wide variety of destinations on one ticket.

In Europe, the major hubs are those operated by Air France-KLM at Amsterdam Schiphol and Paris Charles de Gaulle, Lufthansa at Frankfurt International and British Airways at London Heathrow. These European hubs have faced strong competition over recent years, in particular from Middle Eastern hubs and carriers. (See Figure ES.1).

Figure ES.1: Different international hubs are better placed to compete in different markets due to their location

Top 15 interregional transfer passenger flows, 2012²

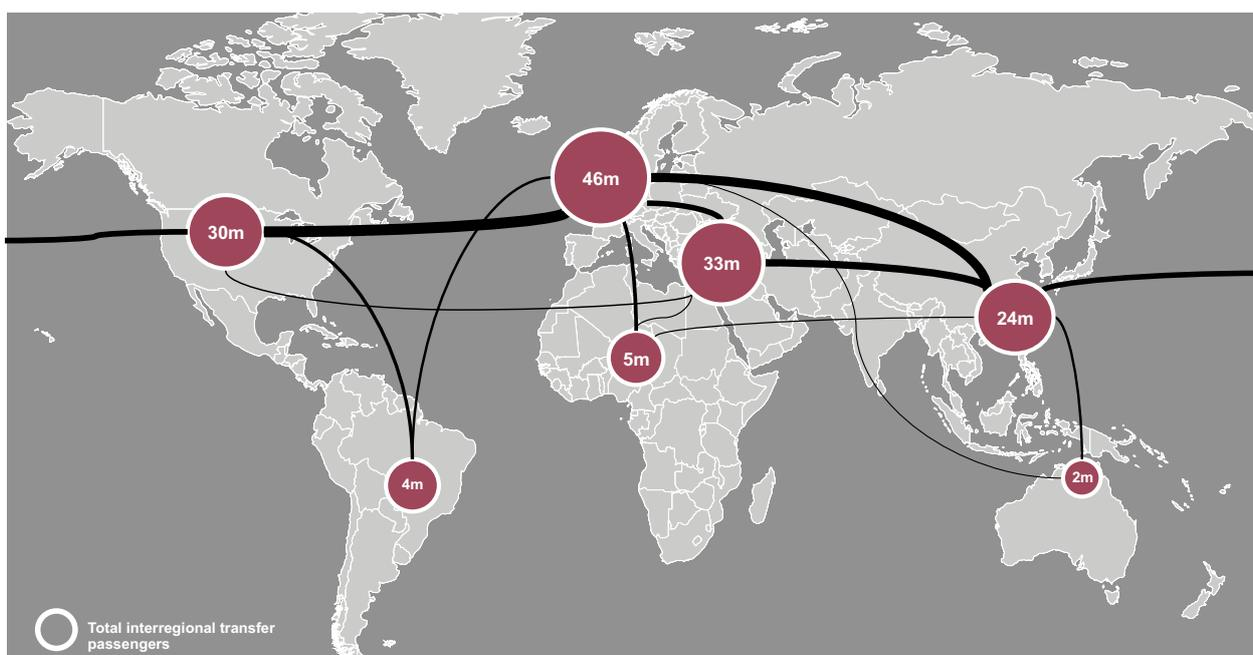

Source: PwC analysis based on Sabre ADI

Globalisation and changes to the way the airline industry is regulated have also driven a process of market liberalisation. These changes are successfully altering a long-standing status quo and exposing legacy airlines to greater competition from new entrants. In Europe and the UK, the low-cost sector has emerged to take advantage of these new freedoms and is continuing to evolve – for example, attracting increasing numbers of business travellers and establishing services and bases at major hub airports.

² Passengers transferring within a region are excluded. Connections to/from Central America and the Caribbean have been excluded.

The development of a more competitive commercial environment in the aviation sector has also coincided with the shift in relative economic power from west to east. As a result, new aviation powerhouses have emerged. For example in Southeast Asia, rapid economic growth and the increasing size and prosperity of the middle class has helped flag carriers in the region feed their hubs with traffic and allowed them to create routes to a wide range of destinations in Europe and beyond.

Whilst it is difficult to predict what the future will bring, some ongoing trends in the aviation sector are apparent and may be expected to continue.

The differentiation between low-cost and legacy carriers will continue to blur, with legacy carriers engaging in cost-cutting measures as the low-cost carriers compete for their passengers.

The launch of the new generation of more fuel-efficient wide-bodied aircraft, the Airbus A350 and the Boeing 787 Dreamliner, means airlines are now able to serve thinner, previously unprofitable routes. But the majority of these have been ordered by legacy carriers and so they are more likely to reinforce the hub model than to challenge it.

Some low-cost carriers are innovating with long-haul services, and new emerging market carriers are establishing routes to the UK. If successful, these aircraft could drive a welcome increase in frequency of service and in competition on the thickest, most popular, intercontinental connections, but they are unlikely to increase substantially the UK's route network.

The broader global trends of consolidation and increasing competition outlined above may also be expected to continue, although the pace at which this happens is uncertain.

And it is very clear that the demand for landing slots in London and the South East of England will continue to grow.

The UK airport sector has responded well to accommodate long-term growth in demand for air travel driven by the trends described above. Airline consolidation and liberalisation have strengthened Heathrow's role as the UK's major hub airport and its dominance in the long-haul market, with around 70% of the UK's scheduled long-haul flights. Whilst Gatwick has sought to compete more fully with Heathrow in this market, and is the UK's second-largest long-haul airport, it still accounts for only around 11% of scheduled flights.

The liberalisation of the aviation market has, however, given rise to a burgeoning low-cost sector, whose largest single base is at Gatwick. There is much more scope to compete strongly for routes and establish connections in the short-haul market. London's attractiveness to inbound carriers and the scale of its home market have increased the

capital's short-haul network and the level of competition further; and short-haul connectivity, as a result, is comparatively evenly distributed across all six London airports.

The UK is currently one of the best connected countries in the world: its diverse and competitive airport system offers more destinations and a greater number of seats than any other European country. But the only major new runways built over recent decades were at Manchester and London City, and Gatwick and Heathrow accommodate more flights than any other one- or two-runway airport in the world. The UK aviation system's ability to respond to global aviation trends and meet the country's connectivity needs is likely to be increasingly limited by capacity constraints in future.

Aviation and climate change

Any change to the UK's aviation capacity to allow the sector to continue to respond to these trends has to be considered in the context of global climate change and the UK's policy obligations in this area.

Even though aviation currently accounts for less than 7% of the UK's overall carbon dioxide emissions, air travel has an extremely high carbon cost compared to other sources. The UK Climate Change Act 2008 sets a legally binding target to reduce overall UK emissions by 80% below 1990 levels by 2050. Aviation will need to play its part, and the Committee on Climate Change has specified a planning assumption for the sector that requires gross carbon dioxide emissions from aviation to total no more than 37.5MtCO₂ by mid century.

To understand the implications of the UK's climate change obligations for its analysis of the need and options for additional aviation capacity in the UK, the Commission has integrated the CCC's planning assumption into its approach to forecasting aviation demand. It has developed two sets of forecasts, one which assumes that carbon-trading, for example through international trading mechanisms, will enable emissions reductions where they are most desirable or efficient across the global economy, for example through an international trading mechanism, and one with a firm aviation emissions cap of 37.5MtCO₂ in place in 2050.

The case for change

A thriving aviation sector is important to the UK's residents and businesses. About half of the British population has travelled by air within the last twelve months.

The majority of flights are taken to visit friends and family abroad or to reach a holiday destination. This leisure travel is not only a critical component of the UK aviation market but is also of significant importance for the wider UK economy: multi-national businesses recruit from a global talent pool for whom the ability to return home to visit parents and children is important; leisure travellers maintain the density and therefore viability of an

airline's route network by providing a steady stream of demand; and in-bound tourism is worth an estimated £56 billion in gross value added to the UK economy.³

Air travel is also crucial to supporting UK businesses and the wider economy. It facilitates trade in services and goods, enables the movement of workers and tourists, and drives business innovation and investment.

The UK's strong services sector, which includes financial services, insurance, creative industries, education and health, is particularly reliant on aviation. It is also critical to British trade and manufacturing, particularly in highly technical industries such as pharmaceuticals. In 2014, the total value of tradable goods carried through UK airports exceeded £140 billion. With the world economy's centre of gravity moving eastward and global supply chains becoming more complex, air connections will be ever more important in establishing access to key export markets for UK firms.

In addition, the aviation sector generated about £12 billion of economic output in 2013 and employs 116,000 workers. It also provides a valuable source of Government revenue through the collection of air passenger duty, which raised over £3 billion in 2013-14.

But problems are starting to emerge and the negative effects of constrained airport capacity in London and the South East are beginning to be felt, especially at the biggest London airports.

Heathrow has been effectively full for many years, and Gatwick is operating at more than 85% capacity and is completely full at peak times. This makes it more and more difficult for airlines to operate efficiently, particularly long-haul carriers who are reliant on the high volumes of demand that can only be achieved at the country's biggest airports. The result is more delays, higher fares and reduced connectivity.

One of the most significant impacts of operating infrastructure close to its limits is a reduction in its ability to recover from unforeseen disruptions, arising from airline behaviour or exogenous factors such as adverse weather conditions. The resulting delays, cancellations and unreliability cause frustration and have a direct economic impact on airlines and their passengers, and ultimately on UK productivity.

Airport capacity constraints also affect the extent to which airlines can serve demand and create significant barriers to entry for new players, putting pressure on the level of fares particularly in the long-haul market. This will drive up the total cost of travel across the UK by £3-4 billion in total by 2050 if no increase in capacity is delivered.

3 Office of National Statistics Publication: Estimates of the Economic Importance of Tourism 2008-2015, December 2014.

Another important consequence is the decline of domestic services from other areas of the UK, particularly the North of England and Scotland, into the largest London airports, impacting the potential growth of their economies. This is particularly an issue at Heathrow, where domestic destinations are getting priced out by more lucrative long-haul routes.

Finally, capacity constraints are having an impact on the UK's connectivity. With no room for additional flights at Heathrow and less and less capacity available at Gatwick, long-haul connections are increasingly focused on the most profitable routes, preventing the development of new links to emerging markets and affecting UK business growth and productivity in those regions. Heathrow's status as an international hub for aviation is also being eroded. To be able to grow its route network it needs to attract significant levels of international transfer traffic to supplement local demand. But declining domestic connectivity, pressures on fares and limited resilience are causing difficulties for the airport in attracting these transfer passengers.

Capacity constraints are therefore increasingly affecting the nation's ability to travel cheaply, conveniently and to a broad range of destinations, impacting the UK's hub status and as a result the wider economy. The Commission's analysis for its *Interim Report* suggested that the costs of failing to address the existing capacity constraints could amount, over a sixty year time period, to £21-23 billion of costs to users and providers of airport infrastructure and £30-45 billion of costs to the wider economy.⁴

In a complex and competitive global environment it would be short-sighted and perilous to place the UK's world-leading connectivity at risk by failing to address these constraints. There is a clear need for one net additional runway in London and the South East by 2030.

The Commission's appraisal and consultation process

In 2013, the Commission invited proposals to increase the UK's aviation capacity. More than 50 options were assessed in detail before a short-list of three schemes was identified: one new northwest runway at Heathrow Airport; a westerly extension of the northern runway at Heathrow Airport; and one new runway at Gatwick Airport, which were taken forward for more detailed development and appraisal.

The Commission also carried out detailed studies of the proposal for a new hub airport in the inner Thames Estuary, concluding in September 2014 that there were substantial

4 These wider economy impacts were based on an earlier version of the Commission's S-CGE analysis. The updated approach used to underpin the analysis presented in consultation and in this Final Report would be expected to show a much higher impact, as indicated by those calculated for the shortlisted schemes and discussed in **Chapter 6** of this Final Report.

disadvantages that collectively outweighed its potential benefits and that it therefore did not represent a credible option for shortlisting.

To inform its assessment of the shortlisted schemes, the Commission designed and consulted on an *Appraisal Framework*, based on sixteen appraisal modules, covering a broad range of environmental, social and economic impacts, as well as assessments of operational and commercial viability and of deliverability.

As a key element of its approach, the Commission created five scenarios for how the aviation sector and broader global economy might develop and incorporated these into its carbon-capped and carbon-traded forecasts of future aviation demand:

- *assessment of need*, where future demand is primarily determined by central projections for economic growth and other macroeconomic factors;
- *global growth*, which sees higher global growth in demand for air travel in the future, coupled with lower airline operating costs;
- *relative decline of Europe*, with higher relative growth of passenger demand in emerging economies and stronger Far and Middle Eastern hubs and airlines;
- *low-cost is king*, where low-cost carriers strengthen their position in the short-haul market and capture a substantial share of the long-haul market; and
- *global fragmentation*, in which protectionist policies, a decline in passenger demand across all world regions and higher operating costs are seen.

These scenarios were used to test the robustness of the Commission's analysis in relation to a range of potential futures. In the light of consultation responses and of independent advice from the International Transport Forum (part of the OECD), the Commission has adapted its approach to use the *assessment of need* scenario as the starting point for its analysis of impacts, and then tested those results against other scenarios as appropriate.

In November 2014 the Commission published its assessments of the three short-listed schemes against the *Appraisal Framework* for consultation. The core purpose of the consultation process was to test the evidence base, to identify any concerns stakeholders may have as to the accuracy, relevance or breadth of the assessments undertaken and to seek views on the potential conclusions that might be drawn from them. As part of this process, the Commission held a full-day public discussion session in each of the local areas around Heathrow and Gatwick to hear first-hand the views and concerns of local stakeholders, including MPs, Councillors, community and business groups.

Over 70,000 responses were received to the consultation from stakeholders on all sides of the debate including airlines and airports, large and small businesses and their

representatives, local authorities and elected representatives at every level, environmental organisations and community groups.

The Commission's analysis of these responses has been used to develop further its evidence base. The Commission has also carried out an additional consultation on the outputs of a more detailed air quality analysis.

The Commission's assessment of the impacts and viability of the three short-listed schemes against the Appraisal Framework objectives are discussed in **Chapters 6 – 12**.

Based on a balanced and integrated consideration of these assessments, the Commission has unanimously concluded that the proposal for a new Northwest Runway at Heathrow Airport, in combination with a significant package of measures to address its environmental and community impacts, presents the strongest case.

The case for expansion at Heathrow

Capacity and connectivity

Heathrow Airport plays a central role in maintaining the London aviation market's position as the largest and most valuable in the world. It provides more than 70% of the UK's long-haul flights, and carries more freight by value than all the UK's other airports combined. It has strong surface transport links and the recently opened Terminals 2 and 5 have significantly improved the passenger experience at the airport.

The airport accommodates more flights on its two runways than any equivalent airport in the world, but has for many years been operating at the limit of the capacity that can be provided. This has reduced its ability to accommodate new routes, has led to high prices for slots at the airport and significant barriers to entry, and has seen the number of links to domestic destinations decline. It has also been damaging for local communities, as it has increased the importance of the airport's small number of pre-6am flights and led to regular losses of runway alternation, and hence respite, in the early morning.

Some long-haul services are available from other London airports, mainly at Gatwick, but these have tended to focus on leisure destinations or routes already served from Heathrow. The capital as a whole has not been able to develop the links to new long-haul destinations, including in emerging markets, that might be expected given the scale of the London market and the changing orientations of UK trade and investment flows.

Expansion at Heathrow would tackle that deficiency directly. New runway capacity would enable passengers and freight users to benefit from additional routes and increasing frequencies delivered by the network carriers, such as British Airways, and the major airline

alliances currently based there. Expansion at Heathrow would not only be of benefit, however, to the established carriers at the airport. By creating a large number of new slots for the first time in several decades, it would create opportunities for other airlines, including low-cost carriers, to enter the market at Heathrow for the first time, enhancing competition and driving down fares.

The substantial suppressed demand for slots at Heathrow Airport means that, as new capacity becomes available, rapid growth in passenger numbers is expected, noticeably faster than with a second runway at Gatwick. This reflects the scale of London's origin and destination market and the attractiveness of Heathrow for passengers due to its strong local transport links, dense route network and frequent services. With expansion, airlines operating from Heathrow could also compete more effectively with other European and international hubs for transfer passengers, which can be a decisive factor in determining the viability of a new route. This combination makes expansion at Heathrow best-placed to enhance the UK's long-haul links, which will be increasingly important as the world economy's centre of gravity continues to shift eastwards.

This analysis is reflected in the Commission's forecasts, which show that increasing capacity at Heathrow would drive significant connectivity benefits, delivering a much stronger long-haul network than would be seen at an expanded Gatwick (see **Figure ES.2**) and would enhance access to this network from the rest of the UK by providing new slots for flights from domestic destinations such as Scotland and Northern Ireland. At the national level, the total number of long-haul seats in 2040 would be 7-16 million higher compared to the baseline, depending on the treatment of aviation's carbon emissions.

Figure ES.2: Heathrow expansion delivers greater long-haul connectivity than a second runway at Gatwick

Number of daily destinations for each scheme, carbon-traded and carbon-capped, assessment of need, 2030-2050

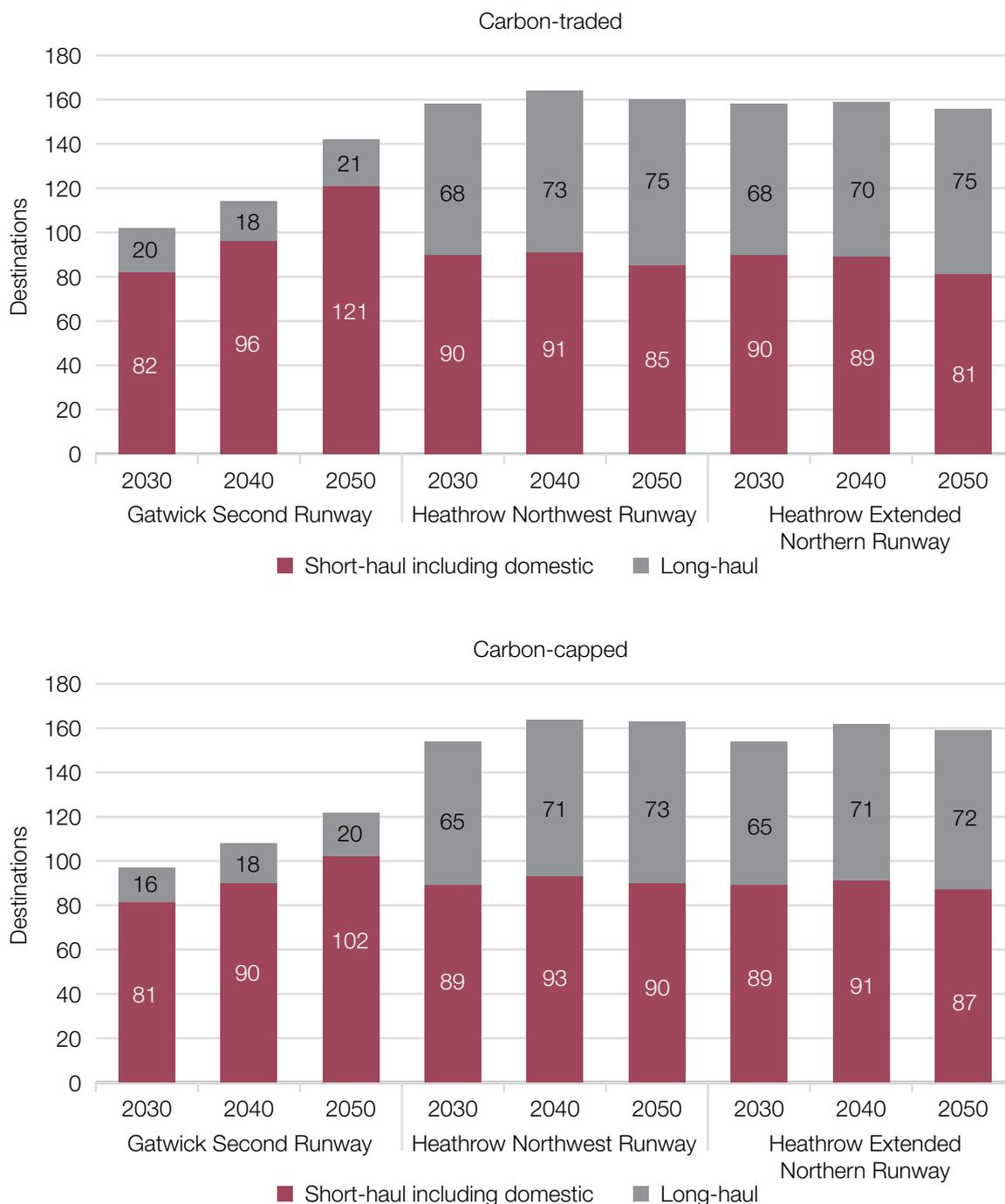

Source: Airports Commission analysis

Expanding Gatwick would also increase the UK’s aviation capacity and would deliver valuable improvements in connectivity, particularly in the short-haul European market. By 2050, its short-haul network would be larger than at an expanded Heathrow. Over the longer-term, increasing numbers of long-haul services would also be established from

Gatwick, but they would be focused mainly on the thickest routes and the number of destinations served would remain smaller than at Heathrow. Expansion at Gatwick would also not deliver the same increase in the scale of the UK’s long-haul network, with only 1-3 million additional long-haul seats by 2040 and 1-5 million by 2050.

For Gatwick expansion to deliver connectivity benefits closer in scale to those from Heathrow, substantial changes would need to be seen, such as an airline alliance moving to the airport, low-cost carriers making significant incursions into the long-haul sector or the structured use of low-cost networks as ‘feeder’ services for long-haul carriers. None of these is impossible, but they would be a risky basis for any long-term infrastructure decision and even if they were to occur, it would not necessarily lead to the establishment of a broader long-haul route network, which will be central to the UK’s long-term economic prosperity.

Accessing the Airport

Heathrow is not just well-connected globally, it also has strong local and national transport connections, which will be further strengthened over the coming years (see **Figure ES.3**), making it accessible to a wide area of the country.

Figure ES.3: An expanded Heathrow would be well-connected to London and the UK

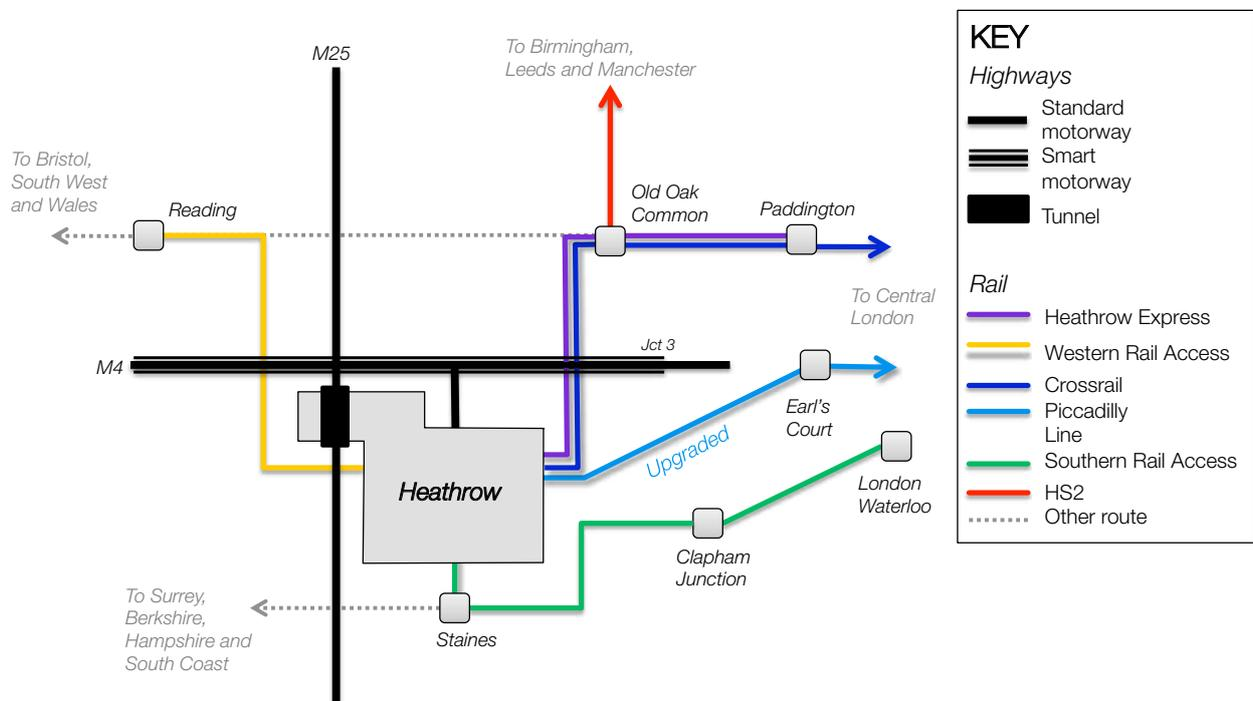

Source: Jacobs

Rail access to London is available via the Piccadilly Line and via Heathrow Connect and Heathrow Express services into Paddington, with the latter reaching the city centre in just 15 minutes. The introduction of Crossrail services to the airport in 2019 will further enhance its links to London, providing direct access to key business districts in the West End, City and Canary Wharf as well as to the major growth areas in the east of the capital. The proposed surface access strategy for the expanded airport also includes a Southern Rail Access link, which will connect the airport to Waterloo and a number of other districts, such as Richmond, which are currently poorly linked to the airport by public transport.

Heathrow's rail links to other regions are not as strong at present, but will be transformed by a combination of the planned Western Rail Link to Reading, enhancing access to the West, South West and Wales, and the connection to HS2 at Old Oak Common. With the full HS2 network in place, this will cut journey times from the Midlands and the North substantially, with Manchester and Leeds moving to within 90-100 minutes of the airport.⁵

Gatwick has convenient rail connections into Victoria and to London Bridge and St Pancras International via the Thameslink route, which also provides a link to Crossrail at Farringdon. Its broader rail connections, however, are not as strong. The Brighton Main Line provides good links to a number of South Coast towns and cities and the upgraded Thameslink network will provide enhanced connections to towns to the north of London such as Cambridge. But the airport would not be connected to HS2 and passengers arriving from the Midlands, the North and the West would need to change at least once to reach the airport.

The levels of crowding seen in peak hours on the rail links serving Gatwick are forecast to be less severe in 2030 than on those serving Heathrow, but for either airport the challenges are primarily driven by background demand growth which the government will need to tackle whether expansion takes place or not.

In respect of the strategic road network, Heathrow's position close to the M25, M4 and M40 makes it well-located for access from much of the country, which contrasts with Gatwick's less convenient location to the south of London and its reliance on the M23. Additional investment in widening, or effective policy measures such as a congestion charge, may, however, be needed to address congestion issues following expansion.

Competition and growth

Expansion at Heathrow would enhance competition at the airport, helping to reduce fare levels and increase choice for passengers. A substantial low-cost presence at the airport, made possible by new slots becoming available, could significantly drive down the costs of

5 See: http://assets.hs2.org.uk/sites/default/files/consulation_library/pdf/P2C37_Journey%20times%20and%20frequencies%20LOW.pdf

travel from the airport and new carriers would also enter the long-haul market, which sees limited competition at present on many routes. The competition benefits from expanding at Heathrow would be stronger than at Gatwick, reflecting the higher level of unmet demand at Heathrow and the greater scope to deliver cost reductions through low-cost competition (even allowing for potential increases in aero charges).

The substantial increases in capacity, connectivity and competition provided by a new runway at Heathrow deliver very substantial benefits for passengers, with a Present Value of £55 billion over 60 years in the Commission's carbon-traded forecast, compared to £47 billion from expansion at Gatwick. The proportion which relates to economically valuable business travel is also higher from expansion at Heathrow. With carbon emissions constrained to the CCC's planning assumption, these benefits reduce but the pattern remains the same.

It is not only passengers, however, that would benefit from expansion at Heathrow. Air freight is also an important contributor to the UK economy, with a particularly important role in supporting trade with countries outside the EU. Heathrow is by some distance the most important freight airport in the country, and its freight operations are very significantly bigger than those at Gatwick: around 17 times larger in terms of tonnage and more than 170 times larger in terms of value. Heathrow's motorway links are also important; Gatwick's position to the south of London limits its effectiveness as a national freight hub.

Overall, the analysis suggests that the strongest benefits for the UK economy are likely to come from focusing capacity where demand is strongest: be that from freight users, leisure passengers, business travellers or the international transfer passengers needed to support a dense long-haul network. In each case, the highest levels of demand are seen at Heathrow.

Providing new capacity at Heathrow would support trade and enhance productivity, strengthen the business clusters around the airport and provide a stimulus to economic growth throughout the UK. The overall effect could be to increase GDP by 0.65-0.75% by 2050, amounting with carbon emissions traded to £131-147 billion in present value terms over the 60 years following expansion. This compares to £89 billion in GDP impacts from expansion at Gatwick. The relative case for expansion at Heathrow is strengthened with emissions limited to 37.5MtCO₂ in 2050, which sees the impacts of Heathrow expansion fall to £103-129 billion, but those of a second runway at Gatwick reduce to £44 billion.

The more that aviation's 'carbon budget' shrinks, the more important it becomes for that budget to be used as efficiently as possible. The most effective option to achieve this is expansion at Heathrow, which provides the greatest benefits for the UK's connectivity and its long-term economic growth.

Securing benefits for the country as a whole

Heathrow Airport is situated in an area of West London in which unemployment is relatively high. Expansion at Heathrow would drive a substantial increase in employment at and around the airport, generating an additional 59-77,000 jobs in 2030 for local people and for the fast-growing wider population in London and the South East, including for black and minority ethnic communities for whom Heathrow is an important employer.

The number of jobs resulting from a second runway at Gatwick would be smaller and the rate of growth slower. In addition, with the exception of Crawley and Mole Valley, the nearby local authority areas have comparatively low levels of unemployment, suggesting that there would be fewer regeneration benefits.

The positive impacts of expansion at Heathrow would also be well-aligned with London's wider development and that of the surrounding region. The airport is situated within the Heathrow Opportunity Area and in the broader 'Western Wedge' corridor running from Paddington to the Thames Valley. The London economy as a whole is driven by sectors which are heavily dependent on aviation, from financial and creative services to high value manufacturing. Heathrow's direct connection to Crossrail will link it to the capital's main business districts.

London also faces other strategic challenges. A rapidly expanding population, due to grow to more than 10 million by 2030, will need homes and jobs. Many of the areas identified for the highest levels of housing growth will have fast and convenient access to the airport via Crossrail or other transport links, including Old Oak Common in West London and the Isle of Dogs, Stratford and Royal Docks in the east.

Expansion at Gatwick would also deliver valuable economic and employment benefits. Gatwick is part of the Wandle Valley strategic corridor and expansion would support Croydon's economic development. It has good road and rail links to the south coast and its expansion is supported by regional business groups. But a second runway at Gatwick could not match the broader strategic impact of new capacity at Heathrow. This is due to the lower overall scale of its impacts, the more limited scale of the regeneration opportunities in the vicinity and its weaker links to the capital's major growth areas.

Outside London, cities and regions across the UK would also benefit from access to the enhanced connectivity secured through expansion at Heathrow. Closest to the airport, the Thames Valley economy is a thriving agglomeration with specialisms in information technology, pharmaceuticals and financial services. Expansion will enhance the region's international connectivity and help to maintain this pattern of success.

Access to international connectivity will also be important in supporting regional economic growth, in line with the Government's evolving policy to create a Northern Powerhouse. The links to HS2 at Old Oak Common and to the Great Western Main Line at Reading, will help to ensure that the benefits of expansion at Heathrow are felt across the English regions. A new runway at Gatwick would neither be as accessible to regional passengers nor deliver the same level of connectivity benefits, particularly in respect of long-haul links.

In addition, for nations and regions where domestic air connections to London remain crucial, such as Scotland and Northern Ireland, expansion will create space at the airport for increased frequencies and new links. Public Service Obligations could be used to support a wide network of domestic routes at Heathrow.

Protecting the local environment and communities

The environmental effects of aviation, particularly in relation to noise and air quality, have consequences for health and wellbeing which need to be carefully considered and addressed wherever possible through effective mitigation and compensation.

Over the coming decades the noise impacts of Heathrow are forecast to reduce significantly, as new and quieter aircraft come into service and as flight paths are redesigned and improved. With expansion, the overall number of flights would grow, but new approach and departure paths could enable the noise impacts to be dispersed more widely, limiting the impacts on any individual community. It would be possible to ensure that noise from the airport, with either option for adding runway capacity at Heathrow, would not exceed current levels across a wide range of metrics, both during the day and at night (see **Figure ES.4**). In addition, expansion would make it possible to eliminate arrivals in the early morning before 6am, which are seen as particularly damaging by local communities.

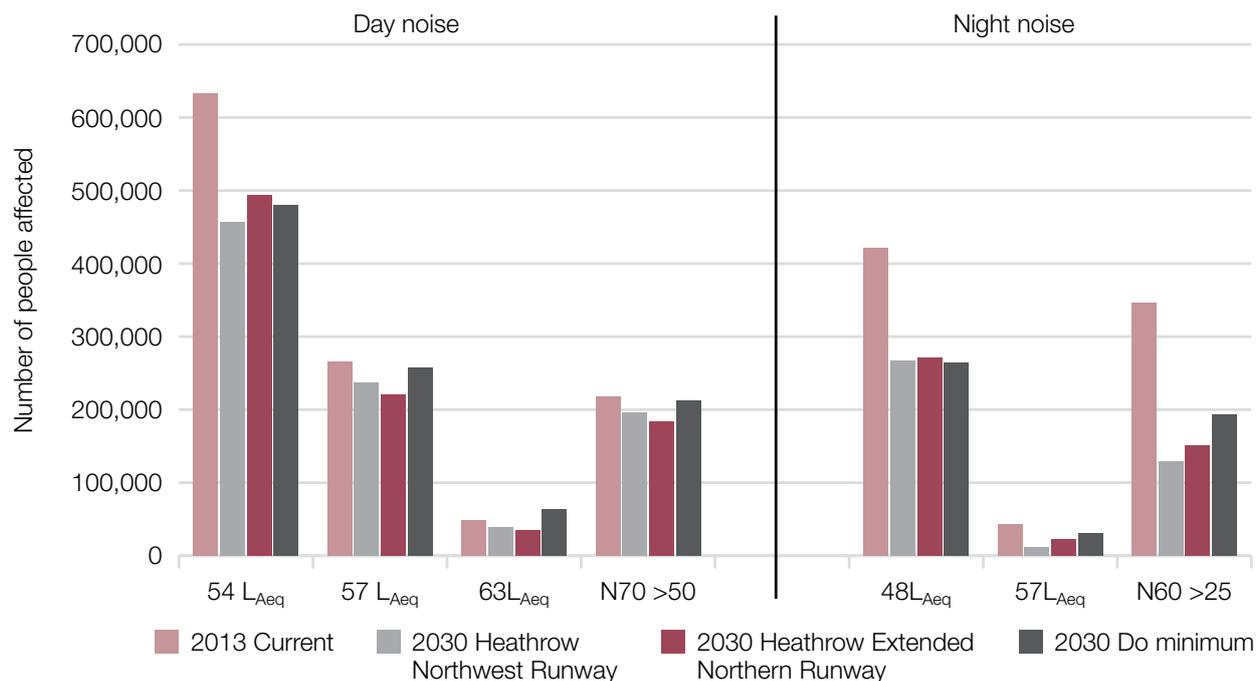
Figure ES.4: Noise impacts of Heathrow expansion, carbon-capped, 2013 and 2030

Source: Airports Commission analysis

To ensure those results are delivered on the ground, a ‘noise envelope’ for the airport should be established which reflects local priorities and incentivises effective measures to mitigate noise impacts. The expanded airport should also provide a level of funding for compensation and noise insulation significantly higher than has been the case historically, including for schools and other community facilities, which would be supplemented by income from an aviation noise levy.

Although an expanded Gatwick would see more people affected by noise than today, its overall noise impacts would still be much less significant than those around Heathrow. In terms of the total number of people affected, an expanded Heathrow would see more than 550,000 people within the 24-hour 55 L_{DEN} contour in 2030 compared to just over 22,000 at Gatwick. That reflects Gatwick’s more rural location, which presents challenges in respect of the airport’s effects on tranquility, but does not outweigh its overall noise advantage.

Air quality in the UK has improved significantly over recent decades and these improvements are forecast to continue. Even with additional runway capacity in place, none of the air quality receptors around Heathrow which would have implications for human health, such as at schools or residential buildings, are forecast to exceed air quality limits in 2030, and although without mitigation up to 47,000 homes around Heathrow would experience a worsening of NO₂ levels, compared to just over 20,000 around Gatwick, the number of properties moving into the ‘at risk’ category is very small.⁶

⁶ The ‘at risk’ category for this purpose is considered to be >32µg/m³ of NO₂.

Heathrow expansion presents particular air quality challenges, however, in relation to the achievement of EU air quality targets on Bath Road close to the airport's northern perimeter. Firm action will be needed on the part of the airport operator to ensure that emissions related to the airport are minimised, together with an effective national strategy to address broader background air quality issues primarily associated with road traffic. Any new capacity should only be released when it is clear that air quality around the airport will not delay compliance with EU limits.

Effective mitigation and compensation will be required to address the impacts of expansion on local villages and communities. The number of homes lost for either Heathrow scheme would be higher than required for a second runway at Gatwick. Both airports have proposed to provide more than the minimum compensation requirement, offering property owners full market value plus an additional 25% and covering reasonable costs.

Each of the three schemes would also have impacts on community facilities and heritage assets, as well as presenting other environmental challenges which would need to be managed through detailed design and mitigation. These include the loss of a valuable area of ancient woodland at Gatwick and an indirect impact on the bird habitats in the South West London Waterbodies RAMSAR Special Protection Area (SPA) site as a result of the two Heathrow schemes. Each of the options would also affect flood risk. Overall, however, those issues are not considered to be unmanageable at either Gatwick or Heathrow.

The Commission's conclusion is that the environmental impacts of expansion at Heathrow, once effective mitigations and generous provision for compensation are in place, do not outweigh its very significant national and local benefits.

Commercial viability and resilience

All three options would be privately funded and delivered, so it is important that they are commercially viable and able to attract the necessary investment.

The Commission's commercial analysis and discussions with investors have suggested that all three short-listed schemes are considered to be commercially viable, although each also presents commercial challenges. For the two Heathrow schemes, they relate principally to the scale of investment required, whereas for the Gatwick scheme they relate more to demand risk. The latter is generally considered by investors to be slightly more significant than the market capacity risks at Heathrow.

In operational terms, it is important that an expanded airport is able to operate resiliently and reliably and offers flexibility to respond to changes in the aviation sector. All three schemes would be operationally viable and likely to deliver enhanced resilience at the expanded airport, but the Heathrow proposals would provide greater flexibility.

Resilience is also an issue in relation to surface access links. The motorway links and the central London sections of the rail lines serving Heathrow are forecast by 2030 to be extremely congested at peak times, which will increase the impacts of minor disruption, such as single-lane closures or rail cancellations and delays. Gatwick is not as susceptible to these, but because it is heavily reliant on a single road and rail route, more significant incidents can have severe consequences. The diverse links serving Heathrow mean that it has greater resilience to major disruption, which is of most concern to passengers.

The best option for expansion at Heathrow

The Commission's view is that with an effective package of mitigation and compensation in place expansion at Heathrow offers a stronger solution to the UK's aviation capacity and connectivity needs than a second runway at Gatwick. There are, however, important differences between the two shortlisted options for expansion at Heathrow.

The proposal for extending Heathrow's northern runway (the scheme proposed by Heathrow Hub Ltd⁷) offers two particular advantages:

- Its estimated costs are roughly £3 billion lower than those of the Northwest Runway option, reducing the financing risk associated with the scheme and lowering the increase in aeronautical charges paid by airlines.
- It would require the loss of only 242 homes compared to 783 for the Northwest Runway option, and its impacts on community facilities such as schools and health centres would also be much more limited.

While these advantages are valuable, however, they must be offset against a larger number of important areas where the Extended Northern Runway scheme performs less strongly.

First, the Extended Northern Runway scheme delivers a lower level of capacity than the Northwest Runway option: 700,000 air traffic movements a year compared to 740,000. This leads to reduced economic benefits and a smaller route network at the airport.

Second, it would not be possible to maintain the principle of respite through runway alternation, which is highly valued by local communities, to the same degree with the Extended Northern Runway scheme as with a new Northwest Runway.

Third, the Extended Northern Runway scheme would continue to concentrate take offs and landings along just two approach and departure paths, leading to higher number of people within the highest noise contours close to the airport.

⁷ Not including the hub station concept, which the Commission considered separately but concluded should not be recommended (see Chapter 8).

Fourth, the Extended Northern Runway scheme presents greater challenges in terms of compliance with the EU Air Quality Directive.

Fifth, the Extended Northern Runway scheme creates a more congested airfield than the alternative option, leading to lower resilience and less space for ancillary development.

On balance, the Commission's judgement is that the Extended Northern Runway presents a less effective proposition to meet the UK's aviation capacity and connectivity needs. It has therefore concluded that the Northwest Runway scheme offers the best option for expansion at Heathrow.

The Commission's recommended option

The Airports Commission's recommendation is that the proposal for a new Northwest Runway at Heathrow Airport, combined with a significant package of compensation and mitigation measures, is the strongest option for expanding the UK's aviation capacity.

This view has been reached following a comprehensive and integrated assessment, incorporating a range of future outcomes for managing carbon emissions from aviation. In order to ensure that its recommendations are robust to the broadest spectrum of potential carbon futures, however, the Commission has also considered a scenario in which the net economic benefits to passengers are reduced to zero, with any benefits from increased passenger numbers through the expanded airport entirely offset by disbenefits resulting from reductions elsewhere.

Even in that extreme scenario, the Commission's judgement is that the strategic case would justify proceeding. Expansion at Heathrow would be commercially viable and would deliver improved reliability and resilience and enhanced competition in the London airports system. It would support growth in air freight, improve regional access to London's international connectivity, and enable the UK aviation system to provide more long-haul connectivity, which will be crucial to the country's prosperity in an increasingly integrated global economy.

In reaching these conclusions, however, the Commission is acutely aware that the concerns of local communities must be taken seriously, by tackling long-standing issues such as night noise, increasing long-term funding for compensation and insulation, giving local people a real say in how the airport operates and ensuring that the new jobs and training generated by expansion are made available to those living nearby.

The Airports Commission believes that these are achievable goals. Accompanied by ambitious measures to address its environmental and community impacts, an expanded Heathrow can be a better neighbour than the airport is today, while delivering significantly enhanced connectivity and long-term economic and strategic benefits for the UK as a whole.

Respecting the needs of local communities

Expansion at Heathrow Airport would provide a unique opportunity to change the way the airport operates and it should be taken forward as part of a broader package that addresses environmental, social and economic impacts. This will mean a significant shift from ‘business as usual’ thinking for airports, communities and government.

The package of measures that the Commission recommends is as follows:

A clear **‘noise envelope’** should be agreed and Heathrow Airport must be legally bound to stay within these limits. This could stipulate that the total number of people affected by noise under expansion should be no higher than it is today. Capping noise levels ensures that the airport and airlines must become more noise efficient if the airport is to grow.

Following construction of a third runway at Heathrow there should be a **ban on all scheduled night flights between 11:30pm and 06:00am**. This is only possible with expansion. Night flights are very unpopular with local residents, and the additional capacity from a third runway would enable airlines to re-time very early morning arrivals, limiting the commercial impact.

A third runway would allow periods of **predictable respite to be more reliably maintained**, even if respite periods from runway alternation would be reduced with additional capacity. Knowing that aviation noise will be limited to certain times of the day is very important to many people. In addition, new approach and departure paths could enable noise impacts experienced further from the airport to be dispersed more widely than at present.

Heathrow Airport Ltd (HAL) has offered to compensate those who would lose their homes at **full unblighted market value plus an additional 25% and reasonable costs**. It should make this offer available as soon as possible.

HAL should be held to its commitment to spend **more than £1 billion on community compensation**, including £700 million on noise insulation, and should be prepared to go further. Support for **schools** should be a priority.

In addition, the Government should introduce a **noise charge or levy at major UK airports** to ensure that airport users pay more to compensate local communities, following the examples of dedicated taxes or charges in France and the USA. The independent aviation noise authority described below should advise on the design of the charge and local people should be able to see clearly how funds are used.

HAL should work with local authorities and schools to provide **apprenticeships and training** to enable local people, including young people, to benefit from the new jobs that

would be generated through expansion. Expansion could generate 59-77,000 additional direct, indirect and induced jobs, which would offer significant opportunities for local people and businesses. HAL should also demonstrate leadership as a community employer by adopting the London Living Wage.

HAL should build on existing plans to commit more than £100 million to local areas through Community Infrastructure Levy payments and Section 106 agreements to **support sustainable development of communities over several years**. It should be for local and national government and the airport in consultation to determine the appropriate contribution the airport should make to support local development.

HAL must be held to performance targets to **increase the percentage of employees and passengers accessing the airport by public transport**, reducing pressure on local roads and air quality. The introduction of a **congestion or access charge scheme** should be considered.

A new **Community Engagement Board** with real influence over spending on compensation and community support and over the airport's operations should be set up under an independent chair. This should draw on the models successfully in operation at Schiphol and Frankfurt Airports.

An **independent aviation noise authority** should be established with a statutory right to be consulted on flight paths and other operating procedures. The authority should be given statutory consultee status and a formal role in monitoring and quality assuring all processes and functions which have an impact on aircraft noise, and in advising central and local Government and the CAA on such issues.

HAL should be **legally bound** to deliver on the promises that it makes to local communities. There should be clear **independent monitoring of performance against commitments** and appropriate means of redress.

Additional operations at an expanded Heathrow must be contingent on acceptable performance on air quality. New capacity should only be released when it is clear that the air quality at sites around the airport will not delay compliance with EU limits. This should be a legally binding planning condition.

Government should make a firm commitment in Parliament to **rule out any fourth runway at Heathrow**, for which there is no operational or environmental case. This may be as part of a National Policy Statement or through legislation.

Supporting growth and connectivity across the UK

It is crucial to ensure that expansion at Heathrow delivers benefits for all of the nations and regions of the UK

A new northwest runway is likely to protect and bolster domestic services in and out of London leading to a rise in the number of passengers and frequency of services on the thickest routes, but more can be done to facilitate connections from the airport to an increased number of domestic destinations.

To secure this, the Commission recommends that:

The Government should alter its guidance to allow **the introduction of Public Service Obligations on an airport-to-airport basis**, and use them to support a widespread network of domestic routes at the expanded airport.

HAL should implement additional measures to enhance domestic connectivity, including **reduced charges and start-up funding for regional services**.

Next steps

The primary responsibility for delivering the new runway at Heathrow is expected to lie with the private sector scheme promoter. Nevertheless, there are a number of processes which will require central Government and other bodies to play an important enabling role.

A timely decision by Government on the Commission's recommendations will greatly facilitate expeditious delivery of new capacity

All parties involved in delivering the runway should agree clear roles and responsibilities. It may be appropriate to set up a Joint Oversight Board.

A stable and predictable economic regulatory environment will be important to help ensure the most efficient financing arrangements for the scheme. Under current market conditions, supportive measures from the Government such as provision of guarantees are unlikely to be required, but ongoing monitoring of the situation will be necessary.

Expansion will have impacts far beyond the airport boundary and the Government should consider establishing a dedicated body to ensure the efficient delivery of a project of this technical and political complexity. In addition, the Government will need to agree the nature, scale and financing of surface transport improvements associated with expansion, including seeking funding contributions from Heathrow Airport Ltd.

There are two main routes for seeking planning consent: through a National Policy Statement and Development Consent Order or through a Hybrid Bill. The decision on this

should form part of a wider discussion between the airport and the Government on how to take the scheme forward. The Government could also deposit a ‘Paving Bill’ or table a motion in Parliament to set out its early commitment to progressing the Commission’s recommendations.

The delivery of any new runway would require substantial changes to London’s airspace structures. This can be completed efficiently, but will need clear direction and strategy and renewed engagement from the Government. This must be treated as a priority.

A second additional runway

Even with a third runway at Heathrow, there would be likely to be sufficient demand to justify a second additional runway by 2050 or, in some scenarios, earlier.

That does not necessarily mean, however, that a second new runway would be justified on economic or environmental grounds. It will be crucial for Government and the aviation industry to drive technological improvement and deliver progress in agreeing an international framework to tackle emissions, if further expansion is not to materially affect the UK’s ability to meet current and future climate obligations.

Future assessments of the case and options for increasing airport capacity should be carried out through an independent, integrated and collaborative approach. It would be appropriate to begin the process early, but no decisions should be taken until the impacts of the new runway at Heathrow and the wider policy and industry context can be evaluated and considered.

If new capacity was found to be necessary and feasible, a wide range of options should be considered. This could include airports previously assessed as part of the Commission process, for example Stansted and Gatwick, and airports outside London and the South East, such as at Birmingham or Manchester. There would not be any credible case, however, for a fourth runway at Heathrow.

Conclusion

The Commission’s view is that, while all three shortlisted schemes were credible options for expansion, the Heathrow Airport Northwest Runway scheme offers the strongest solution to the UK’s aviation capacity and connectivity needs.

Accompanied by ambitious measures to address its local impacts, an expanded Heathrow can be a better neighbour for local communities than the airport is today, while delivering significantly enhanced connectivity and substantial long-term economic and strategic benefits for the UK as a whole.

The Commission urges the Government to take an early decision to ensure that new capacity is put in place as soon as possible and the UK's position as Europe's most important aviation hub is secured.

1. Introduction

1.1 In September 2012, the Government asked Howard Davies to chair an independent Commission to identify and recommend options to maintain the UK's position as Europe's most important aviation hub.

1.2 In addition to the Chair, the members of the Airports Commission are Sir John Armit, Professor Ricky Burdett, Vivienne Cox and Professor Dame Julia King.⁸

1.3 The Government set the following terms of reference:⁹

The Airports Commission will examine the scale and timing of any requirement for additional capacity to maintain the UK's position as Europe's most important aviation hub, and it will identify and evaluate how any need for additional capacity should be met in the short, medium and long term.

It should maintain a UK-wide perspective, taking appropriate account of the national, regional and local implications of any proposals.

It should engage openly with interested parties and members of the public, providing opportunities to submit evidence and proposals and to set out views relevant to its work.

It should seek to engage with a range of stakeholders, including with local and devolved government as well as the opposition, to build consensus in support of its approach and recommendations.

The Commission should report no later than the end of 2013 on:

- *its assessment of the evidence on the nature, scale and timing of the steps needed to maintain the UK's global hub status; and*
- *its recommendation(s) for immediate actions to improve the use of existing runway capacity in the next 5 years – consistent with credible long term options*

The assessments and recommendations in the Commission's Interim Report should be underpinned by a detailed review of the evidence in relation to the current position in the UK with regard to aviation demand and connectivity, forecasts for

8 A sixth member of the Airports Commission, Geoff Muirhead, resigned in September 2013.
9 <https://www.gov.uk/government/organisations/airports-commission/about/terms-of-reference>

how these are likely to develop, and the expected future pattern of the UK's requirements for international and domestic connectivity.

Its assessments of potential immediate actions should take into account their economic, social and environmental costs and benefits, and their operational deliverability. It should also be informed by an initial high-level assessment of the credible long-term options which merit further detailed development.

The Commission should report no later than summer 2015 on:

- its assessment of the options for meeting the UK's international connectivity needs, including their economic, social and environmental impact;*
- its recommendation(s) for the optimum approach to meeting any needs; and*
- its recommendation(s) for ensuring that the need is met as expeditiously as practicable within the required timescale.*

The Commission should base the recommendations in its Final Report on a detailed consideration of the case for each of the credible options. This should include the development or examination of detailed business cases and environmental assessments for each option, as well as consideration of their operational, commercial and technical viability.

As part of its Final Report in summer 2015, it should also provide materials, based on this detailed analysis, which will support the government in preparing a National Policy Statement to accelerate the resolution of any future planning applications for major airports infrastructure.

1.4 The Airports Commission is not the first body to consider airport capacity in the UK: the question of airport expansion has been looked at a number of times over past decades.¹⁰

1.5 The Roskill Commission in 1968 recommended a new airport at Cublington (in Buckinghamshire), with a minority report favouring Maplin Sands (in the Thames Estuary). Neither airport was built. Further attempts were made in the late 1970s and in the early 1990s, each time recommending additional capacity at Heathrow Airport. Most recently, the 2003 White Paper *The Future of Air Transport* concluded that a second runway should be built at Stansted, followed by a third at Heathrow (which, it should be emphasised, was different from the schemes considered by the Airports Commission for additional runways at that airport), if certain environmental

¹⁰ For a summary of the policy developments, see, for example, <http://www.parliament.the-stationery-office.co.uk/pa/cm200708/cmselect/cmtran/119/119we35.htm>

standards could be met. That proposal was rejected in 2010 by the incoming Coalition Government.

- 1.6** The Airports Commission has sought to learn from that history and to identify recommendations which are balanced, evidence-based and deliverable, taking account of both national priorities and the needs and concerns of those living near to the UK's major airports. The Commission has therefore followed an inclusive and integrated approach, with an open and transparent process, and regular opportunities for interested parties to submit evidence and views.

An integrated approach

- 1.7** The Commission has considered a range of economic, social and environmental factors. It has not followed a mechanistic 'predict and provide' approach, based on forecasting future demand for aviation and then meeting that demand no matter the cost. It has commissioned new research and analysis, developed new assessment methodologies, for example in relation to valuing aviation noise impacts, and sought to consider impacts across the aviation system, including on air traffic and airspace, surface access to airports, cost and deliverability.
- 1.8** An important part of the integrated approach was the development of different scenarios for how the aviation industry may develop, which were used to test the robustness of the Commission's assessments. Over the past few decades the global aviation industry has been rapidly changing and how it will evolve over the coming decades is very difficult to predict. Through looking at different possible aviation demand scenarios and different ways in which airlines may supply future connectivity, the Commission has sought to ensure that its recommendations will serve the UK for years to come. This approach was also used in its assessments of the short-listed options as explained in **Chapter 6**.
- 1.9** Aviation is an increasingly significant contributor to both global and UK carbon emissions. An important part of the scenario-based approach therefore entailed considering the potential impacts of expansion under two different policy frameworks to manage carbon emissions from aviation in the UK referred to as carbon-capped and carbon-traded. **Chapter 2** discusses these two policy frameworks in greater detail.

An open and transparent process

- 1.10** The Commission has adopted an open and transparent process throughout, by engaging with a wide range of stakeholders and through reviewing the

evidence objectively, with the involvement of experts in the areas that the Commission has assessed.

1.11 To inform the preparation of its *Interim Report*, the Commission published and consulted on seven discussion papers, covering:

- Aviation demand forecasting
- Aviation connectivity and the economy
- Aviation and climate change
- Airport operational models
- Aviation noise
- Utilisation of the UK's existing airport capacity
- Delivering new runway capacity

1.12 In addition, it issued two calls for evidence: one inviting short- and medium-term proposals to make best use of the UK's current aviation capacity and the second seeking long-term proposals to expand aviation capacity. Stakeholders were subsequently provided with an opportunity to comment on the ideas submitted.

1.13 The Commission scrutinised all the responses it received and published an *Interim Report* with its recommendations for short- and medium-term actions to optimise the use of existing airport capacity in the UK, as well as its short-list of different long-term aviation capacity expansion options. These recommendations are set out in the box below.

Airports Commission: *Interim Report* recommendations

Short- and medium-term measures

The Commission recommended a number of changes to improve the current use of existing capacity. These included an 'Optimisation Strategy' to improve the operational efficiency of UK airports and airspace; the establishment of two bodies: a Senior Delivery Group to help the implementation of the future aviation policy changes and an Independent Aviation Noise Authority to provide expert and independent advice on noise impacts; and a package of surface transport improvements to make airports more attractive to passengers and airlines.

In November 2013, shortly before the publication of the *Interim Report*, the Chair of the Commission wrote to the Chancellor of the Exchequer about the Commission's recommendations on improving surface access links to airports, so as to promote the more effective use of existing capacity. HM Treasury's second National Infrastructure Plan, published in December that year, began the process of implementing those recommendations.

Since the publication of the *Interim Report*, the Commission has been pleased to note the progress that has been made on the improvement of Gatwick Airport Station, which was one of its key recommendations. The Commission has continued to call for priority to be given to improving surface access links to other airports. The Commission responded to Network Rail's consultation on the Anglia Route Strategy, calling for a more joined-up approach to meeting the needs of users of Stansted Airport.

The role of the Senior Delivery Group was to drive forward the implementation of the Future Airspace Strategy and the delivery of the Commission's recommendations in respect of airspace and operations. The Group was established in the summer of 2014 and has produced a number of suggestions for improving the airspace change process to enable more rapid progress to be made in these areas. But real progress so far has been limited, with few concrete proposals and a lack of engagement from Government, including on recommendations for an independent aviation noise authority, which has been disappointing.

Long-term recommendations

The Commission demonstrated a clear case for one net additional runway in London and the South East by 2030. Gatwick and Heathrow Airports were identified as credible locations for an additional runway, with two alternatives for expansion at the latter. A programme of work to appraise these options in more detail was begun. It involved close consultation with promoters and local communities living around the two sites.

The Commission also decided to carry out further analysis on the feasibility of an airport in the inner Thames estuary before taking a decision on whether or not to add that option to its shortlist.

- 1.14** Following the publication of its *Interim Report*, the Commission developed and consulted on a draft *Appraisal Framework* to be used as the basis for its analysis of the shortlisted options for new capacity.

- 1.15** It also published a further call for evidence on the option of constructing a new airport in the inner Thames estuary and undertook four feasibility studies. Having consulted on these feasibility studies and considered the responses to its call for evidence, in September 2014 the Commission decided not to add the inner Thames Estuary airport proposal to its shortlist. The reasons for this decision are set out in **Chapter 3**.
- 1.16** The Commission then consulted on its detailed assessments of the three shortlisted options. This consultation ran for three months from November 2014 to February 2015 and attracted more than 70,000 responses. The Commission has also consulted on more detailed air quality analysis, receiving over 1,800 responses.
- 1.17** As well as providing opportunities to contribute to its process through formal consultation responses, the Commission has also engaged directly with stakeholders through public discussion sessions and a substantial programme of meetings and visits.
- 1.18** Prior to its *Interim Report*, it held two public evidence sessions, one in Manchester and one in London, to inform its assessment of the overall need for new capacity in the UK. Speakers at these sessions included representatives from a number of the UK's major airlines and airports, environmental NGOs and business groups.
- 1.19** In December 2014, as part of the its consultation on the three shortlisted options, the Commission held two public discussion sessions at Heathrow and at Gatwick. Speakers at these events included MPs and councillors, campaign groups and representatives of local and regional businesses as well as the promoters of the three shortlisted schemes.
- 1.20** In both cases members of the audience were given the opportunity to ask questions or make statements from the floor. Transcripts were published on the Airports Commission website.
- 1.21** Members of the Commission have held more than 150 meetings with stakeholders and undertaken an extensive programme of visits. That included visiting major airports in the UK and abroad, airframe and engine manufacturers, transport providers, and the local areas surrounding the locations considered for expansion. In the latter case, this incorporated early morning visits to experience directly the noise from night flights and visits to local schools and businesses. Details of these meetings are available on the Commission's website.

- 1.22** The Commission has been supported in its work by a Secretariat team, comprising civil servants with wide-ranging experience across a number of Government departments and secondees from other organisations.
- 1.23** It also appointed an Expert Advisory Panel to help it access, interpret and understand the evidence base relevant to its work. The membership of the Expert Advisory Panel covered a range of subject areas including noise and air quality, climate change, economics, finance, airspace operations and surface transport. A list of the panel's members and its terms of reference are provided in Annex A.
- 1.24** The Commission has utilised support and advice from a number of specialist public bodies, such as the CCC, CAA, Network Rail, and Highways England, as well as private consultancies, notably Jacobs, LeighFisher and PwC – and organisations with specific expertise such as NATS and the International Transport Forum at the OECD.
- 1.25** This *Final Report* sets out the Commission's assessment of the three shortlisted options for expanding the UK's aviation capacity, and its recommendations as to which of the options best addresses the UK's capacity and connectivity needs. It is structured as follows:
- **Chapter 2** sets out the global and national aviation context for the Commission's work;
 - **Chapter 3** explains the case for expanding aviation capacity in the UK;
 - **Chapter 4** sets out how the three shortlisted options were identified;
 - **Chapter 5** describes the three shortlisted options;
 - **Chapters 6 to 12** summarise the detailed assessment of these options against the *Appraisal Framework*;
 - **Chapter 13** sets out the Commission's recommended option;
 - **Chapters 14 and 15** propose a package of measures to accompany the delivery of the recommended option; and
 - **Chapter 16** discusses the next steps in taking forward the recommended option.

1.26 Alongside its *Final Report*, the Commission has published: a detailed *Business Case and Sustainability Assessment* for its recommended option; a report covering the responses received to consultation and the key themes raised in them; the technical responses received to the consultation; and a number of supporting documents setting out the additional analysis carried out following consultation. The Commission has also published a separate report on the responses to its more recent consultation on its detailed air quality analysis.

2. The global and national aviation context for the Commission's work

2.1 This Chapter provides an overview of the Commission's analysis of recent developments in the global aviation sector. The Chapter also sets out the Commission's findings on the strengths and weaknesses of UK airports and the connectivity they support, which was the starting point for its assessment of the UK's future aviation capacity needs.

The global aviation sector

2.2 Aviation is in a constant state of evolution as airlines find new ways of responding to changes in passenger needs. Airlines must adapt their businesses to the growing integration of the world economy, to technical innovation, and to national and international requirements to curb the sector's environmental impacts.

2.3 This means that the world has moved on significantly since the UK government last considered airport capacity in its 2003 White Paper. The paper did not, for example, consider the rise of Middle Eastern hub carriers (Dubai is in fact mentioned only once, in the context of Emirates launching a new route from Glasgow International Airport).

2.4 There will undoubtedly be further evolution before a new runway is built, but some drivers of change seem clear. The developed economies of Europe and North America are now on a slower growth path than before the recent financial crisis while the global economy's centre of gravity is moving eastwards, pulled by fast growing Asian economies. Environmental and climate change issues are becoming the focus of a global policy agenda, with transport at the centre of the debate.

2.5 But other factors are less predictable. Although fossil fuel usage is still increasing, alternative sources of power are being developed. If they succeed, aviation may experience yet another technological revolution. Increased liberalisation in the aviation sector has enhanced competition between carriers, creating opportunities for market growth and making aviation more accessible, as route networks expand and fares decrease. The continuation of this pattern cannot, however, be guaranteed. There may be further geopolitical changes which could affect demand for flying, either up or down.

2.6 As the *Interim Report* set out, two parallel paths of development have been observed in the aviation market over the past two decades – one of consolidation, partnership and network integration; the other of new entrants and expanding point-to-point travel.

Alliances and hub-and-spoke networks

2.7 Although some consolidation has been seen over recent years, particularly in the North American and European markets, the global airline industry remains fragmented in large part due to the restrictive ownership rules imposed by many countries. The response from legacy carriers (current or former state-owned airlines which, prior to recent deregulation, had monopoly rights in domestic markets) has been the development of three global ‘alliances’:

- SkyTeam, which includes the Air France-KLM group, Delta, Garuda and a number of Chinese airlines;
- Star Alliance, of which Lufthansa, United, Air China and Turkish Airlines are leading members; and
- oneworld, at the heart of which are American Airlines, Cathay Pacific and the International Airlines Group (IAG) comprising British Airways (BA), Iberia and a number of smaller airlines.

2.8 The reach of these alliances has expanded rapidly. Whereas when they began in the 1990s the vast majority of their members were established European, Asian and North American carriers, they now include airlines from across the developing world, including from the Far East, Africa and South America. For example, Star Alliance’s founder members in 1997 were Lufthansa, United, Air Canada, Thai Airways and SAS, whereas its membership now includes airlines from Brazil, China, Egypt, Ethiopia and Panama. They are also beginning to attract some Middle Eastern and low-cost carriers, with both Qatar Airways and airberlin having joined the oneworld alliance over recent years.

2.9 These alliances currently control more than half of global seat capacity. Their dominance is particularly strong in the markets for long-haul, intercontinental travel. These markets are heavily concentrated, with many routes being served by only one or a handful of carriers (see **Figure 2.1**).

Figure 2.1: The three major alliances dominate intercontinental connections

Airline alliance market share by seat capacity, January – June 2012

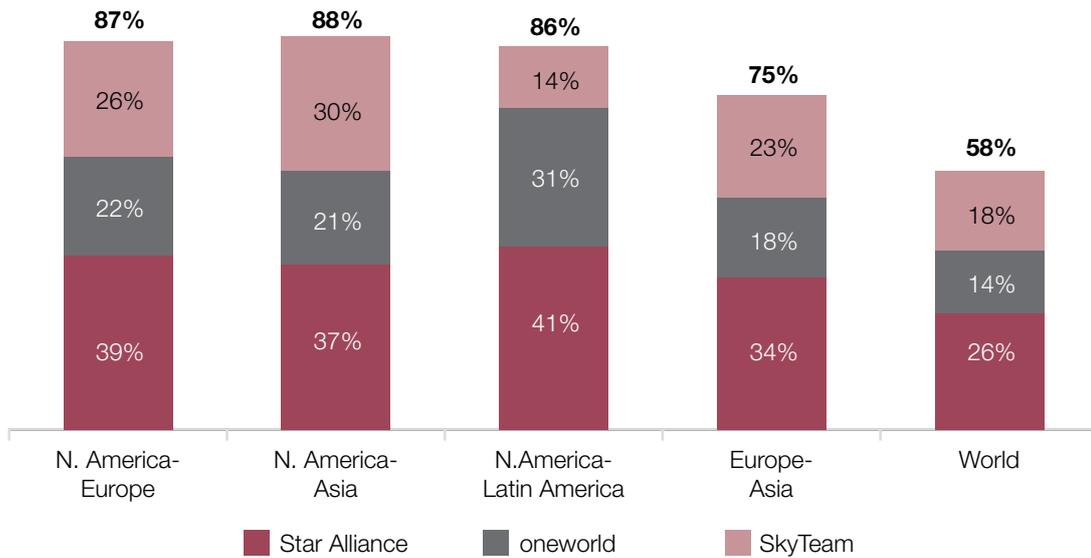

Source: Deutsche Bank (May 2012), 'Global Airline Sector – Achieving Financial Stability through Consolidation'

2.10 The initial role of the alliances was to coordinate marketing and ticket sales, but they have more recently begun progressing more ambitious projects such as investment in shared facilities, including integrated check-in areas at major airports. The links between airlines provided by the alliances are also increasingly being supplemented by other forms of cooperation, including partnerships on specific routes, joint ventures and quasi mergers.

2.11 An important consequence of this consolidation in the airline industry and the rise of alliances has been the expansion of the 'hub-and-spoke' networks run by major carriers at the world's largest airports.

Hubs are ‘factories’ to create route density

In hub-and-spoke networks, airlines and alliances route their traffic through one or more key airports (‘hubs’), with feeder traffic from other airports in the network (‘spokes’) supplementing local origin and destination traffic at the hubs.

By supplementing local demand with transfer traffic, the hub operations of network carriers allow airports to grow their network of frequently served destinations beyond what the local OD-market would be able to support, as explained in the Commission’s discussion paper Airport Operational Models.

For example, an airline that operates direct services between three pairs of airports (A-D, B-E, and C-F) could instead route its flights via a hub (H) as shown below.

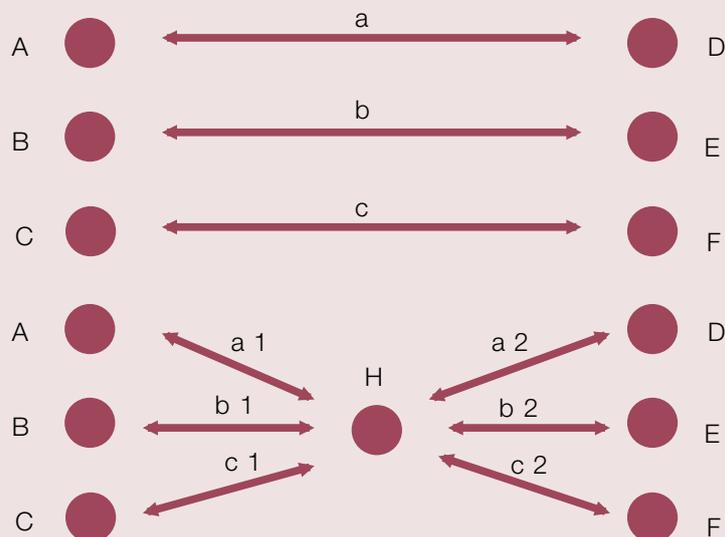

This creates more route options, with passengers travelling from any airport in the network now able to access five different destinations (or six, including the hub itself). Furthermore, the additional passengers transiting through the hub make it more viable for airlines to add new routes at that airport or increase frequencies on existing routes, bringing further connectivity benefits. On the other hand, such a model may incentivise airlines to replace some thinner direct routes with routes that involve a transfer, which is less convenient from the perspective of those passengers who travel on this particular route.

For airlines and alliances, pooling traffic in this way maximises passenger load and yields, and concentrating operations at a few key airport locations can help to drive down operating costs. For passengers, the hub-and-spoke model maximises the choice of direct destinations at a hub and offers potential to travel to a very wide variety of destinations on one ticket.

2.12 Different hubs are best able to serve different markets. For example, the Middle Eastern hubs' position between South Asia and Europe, together with the wide range of destinations they serve on the Indian Sub-continent, makes them well-placed to connect passengers on these routes. European hubs, in contrast, are very well-positioned to connect the cities of East Coast North America to growing markets in Africa. This division of labour is a function of their geographical location, their historic position in the global route network (which often reflects historic, cultural and trading links), and the socio-economic nature of the country where the hub is located (see **Figure 2.2**).

Figure 2.2: Different international hubs are better placed to compete in different markets due to their location

Top 15 interregional transfer passenger flows, 2012¹¹

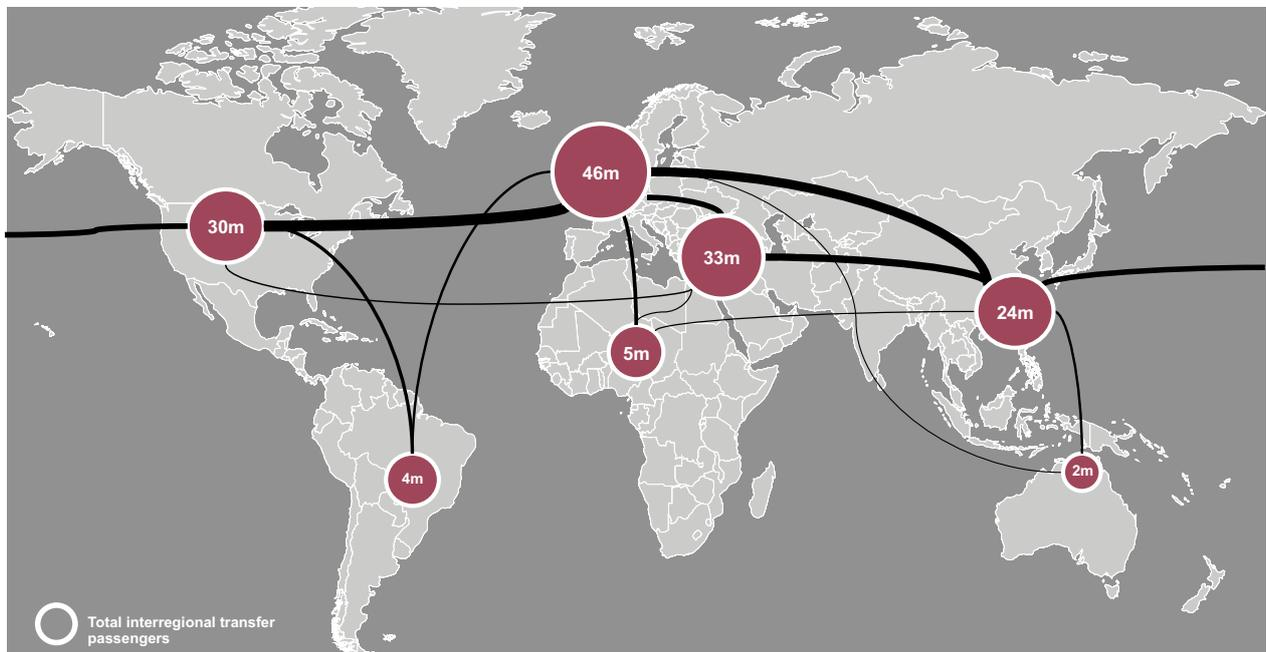

Source: PwC analysis based on Sabre ADI

2.13 The market for transfer passengers is heavily contested by network carriers who rely on connecting traffic to support a choice of destinations. In Europe, the Air France-KLM group at Amsterdam Schiphol and Paris Charles de Gaulle, the Lufthansa Group at Frankfurt International, and IAG at London Heathrow, attract significant numbers of transfer passengers.

11 Passengers transferring within a region are excluded. Connections to/from Central America and the Caribbean have been excluded.

2.14 These European hubs have faced strong competition over recent years from Middle Eastern hubs and carriers. While all four European hubs have seen 0.3-2.1% annual growth of their transfer traffic over the past decade, the Emirates hub in Dubai has experienced annual growth of over 12%. This growth has been facilitated by the large-scale expansion of the airport (terminal capacity having more than doubled from 23 million in 2002 to 75 million in 2012) and the rapid growth of Emirates Airline (the flag carrier of Dubai), so that Dubai Airport was not impacted by the general downturn in the aviation industry during 2008 and 2009.¹² Emirates currently serves 6 destinations in the UK, providing opportunities for UK passengers to transfer through Dubai International mainly to destinations further east. Other powerful hubs in the region include Qatar Airways's base at Doha, Etihad's at Abu Dhabi and Turkish Airlines' at Istanbul Atatürk Airport.

The rise of new entrants

2.15 Although a higher degree of fragmentation and protectionism has endured in aviation than in many other major industries, globalisation and changes to the way the airline industry is regulated are increasingly driving a process of market liberalisation.

2.16 This began in the US, which deregulated its airline sector in 1978, and was continued in Europe, which undertook a series of reforms between 1987 and 1997, although in both cases reform was focused on internal deregulation, with limited impact in other areas of the world. Some more far-reaching reforms have, however, begun to take place since then, most notably the Open Skies agreement signed in 2008 between the EU and US.

2.17 These changes are successfully altering a long-standing status quo based on the monopoly rights of legacy carriers in domestic markets and bilaterally negotiated international traffic rights. In doing so, they are exposing previously protected airlines to greater competition from new entrants.

2.18 In Europe, deregulation of the EU market has undermined the dominance of European flag carriers. As slots became available at previously restricted airports, and as European carriers obtained the freedom to operate between airports anywhere in the EU, the low-cost sector emerged to take advantage of these new freedoms.

¹² PwC (December 2013): Historical trends in international-to-international interliners, <http://www.gov.uk/government/publications/airports-commission-interim-report>

2.19 Over the past twenty years, the rise of the low-cost airline model has been dramatic. In 2013 Ryanair was the fifth biggest airline in the world in terms of passengers carried, while easyJet was tenth, ahead of such groups as Air France-KLM or IAG. Some flag carriers have disappeared; others have downsized.

2.20 In the UK alone, low-cost carriers served almost 100 million passengers last year, or about 40% of the total market (see **Figure 2.3**).

Figure 2.3: Low-cost carriers in the UK have captured a substantial part of the aviation market

Number of passengers flying by type of carrier, 1991-2014

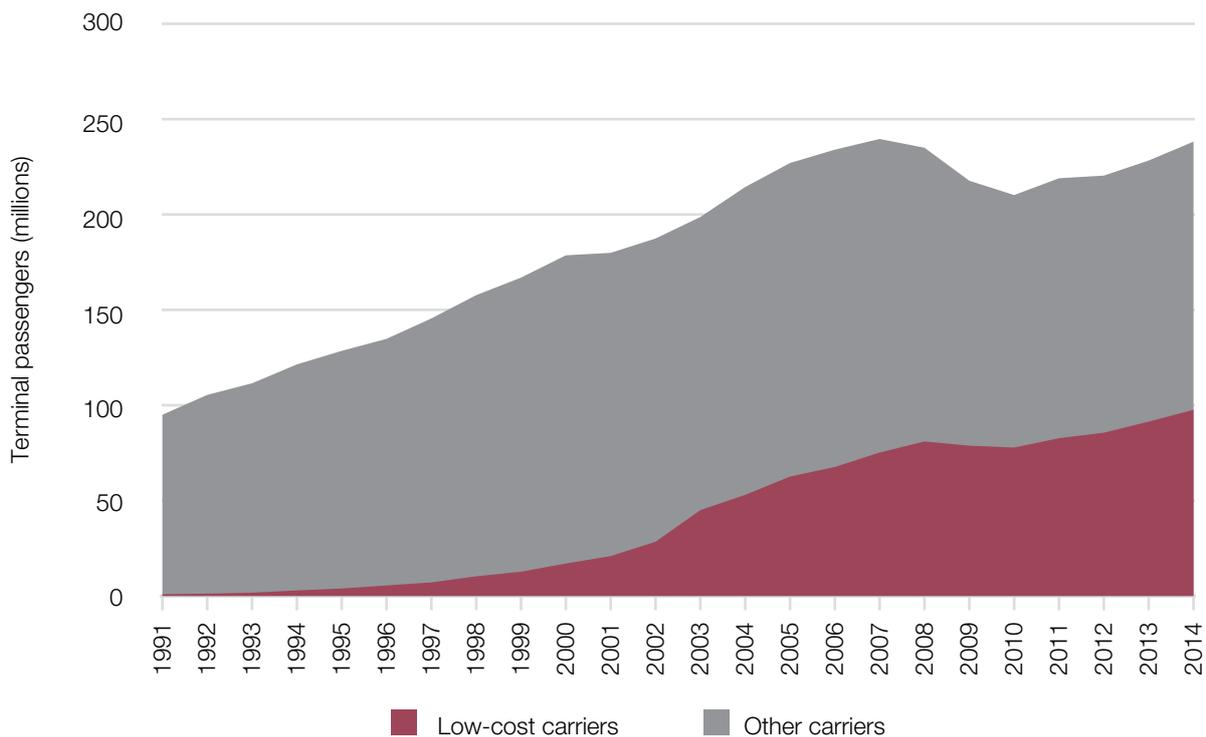

Low-cost carriers in this graph includes the following carriers; easyJet, Flybe, Jet2, Norwegian Air Shuttle, Ryanair, Transavia, Volotea, Vueling Airlines and Wizz Air.

Source: DfT analysis of CAA airport statistics

2.21 Unburdened by legacy costs such as salaries with relatively high benefit packages, operating only one efficient model of aircraft at high rates of utilisation, maximising online ticket sales and check-in to reduce administration, and providing a single standardised service, low-cost airlines such as Ryanair, easyJet or Wizz Air increasingly dominate short-haul routes in Europe of up to four or five hours.

2.22 And the low-cost revolution is not over as carriers are constantly adapting to the changing trends in demand for aviation. Companies like easyJet and Ryanair are becoming more focused on attracting business travellers, providing more flexibility in terms of ticket sales and priority boarding. Most have remained focused on short-haul connections and maintain that their business model is not relevant to

longer routes, but Norwegian Air Shuttle is currently offering long-haul services from its bases in Oslo, Stockholm and London.

- 2.23** The development of a more competitive commercial environment in the aviation sector has also coincided with a shift in relative economic power from west to east. As a result, new aviation powerhouses have emerged. In Southeast Asia, rapid economic growth and the increasing size and prosperity of the middle class has helped flag carriers in the region fuel their hubs with traffic and allowed them to create routes to a wide range of destinations in Europe and beyond.
- 2.24** A number of Asian carriers have joined alliances or entered into code share agreements to tap into passenger markets in the developed world in exchange for widening their partners' route networks beyond what was previously possible in the region. For example, Air China, with its well-developed route network in Asia, became an official member of Star Alliance in 2011, while China Southern Airlines serves SkyTeam's routes to Australia. Turkish Airlines, based at Istanbul Atatürk Airport, joined Star Alliance in 2008 and India's flag carrier, Air India, joined in 2014.
- 2.25** Singapore Airlines, also a member of Star Alliance, operates a hub at Changi Airport in Singapore and has an extensive route network in Southeast Asia, Australia and Oceania. The carrier bases its business on a portfolio of subsidiaries operating different business models, including low-cost carriers Scoot and Tigerair.

The future of the global aviation sector

- 2.26** While it is difficult to predict what the future will bring, some ongoing trends in the aviation sector are apparent and may be expected to continue.
- 2.27** First, the differentiation between low-cost and legacy carriers is blurring. Low-cost carriers are now successfully competing for business passengers. easyJet already serves many of the larger European airports, including Amsterdam, Frankfurt and Paris Charles de Gaulle and reports over 21% of its passengers to be business travellers. Some passengers, rather than connecting using formal partnerships between carriers, connect on their own initiative or with the assistance of an airport, for example, through services such as 'Gatwick Connect', or a third party ('self-hubbing').
- 2.28** At the same time, legacy carriers have engaged in cost-cutting measures, especially on their short-haul networks where they need to compete with cheaper alternatives. Some, like Lufthansa or IAG, have launched their own low-cost subsidiaries. Most have adapted their short-haul operations to the low-cost model, implementing

faster aircraft turnarounds, increasing seat density, cutting the services included in the price of the ticket, and introducing fees for luggage and meals on-board.

- 2.29** Second, with the launch of the new generation of more fuel-efficient wide-bodied aircraft, the Airbus A350 and the Boeing 787 Dreamliner, airlines are now able to serve thinner, previously unprofitable routes.
- 2.30** Many stakeholders have commented on the potential impact of these aircraft on future route networks. Some pointed out that, as airlines are now able to serve thinner long-haul markets, this will diminish the demand for hub-and-spoke networks as hubs will gradually be bypassed and direct connections offered to secondary long-haul destinations. Others have noted that so far most of the new generation aircraft have been ordered by full service carriers planning to use them to add more spokes to their hubs. Some submissions have also highlighted the potential impact of low-cost carriers entering the long-haul market. That, in their view, would reduce the importance of transfer passengers in providing a wide range of long-haul connections.
- 2.31** The Commission has considered whether the launch of the new generation of wide-bodied aircraft could have any significant impacts on future route networks. Its conclusion is that, even if the low-cost long-haul business model proves successful, it would not have a material impact on the size of the long-haul route network available from the UK. First of all, only a handful of the new generation aircraft have been ordered by low-cost carriers such as Norwegian. The majority have been ordered by legacy carriers who have already begun using them to strengthen their hub operations. Second, low-cost carriers are expected to focus predominantly on the thickest long-haul routes, which implies that any material change in the size of the network coming from this market segment is unlikely. There could, however, be a welcome increase in frequency of service and in competition, potentially driving down fares on the thickest intercontinental connections both from London and the UK airports, particularly to North America.
- 2.32** Another important trend is that of rising inbound travel into Europe from emerging market economies. IATA's forecasts (see **Figure 2.4** below) predict that over the next two decades the growth of the origin and destination (OD) market in China alone is predicted to be greater than that in the US, UK and Germany combined, and growth in demand in India, Indonesia and Brazil will be bigger than in any European country.

Figure 2.4: Most of the growth in demand in the future will come from emerging-market economies

Additional OD passengers per year in 2034

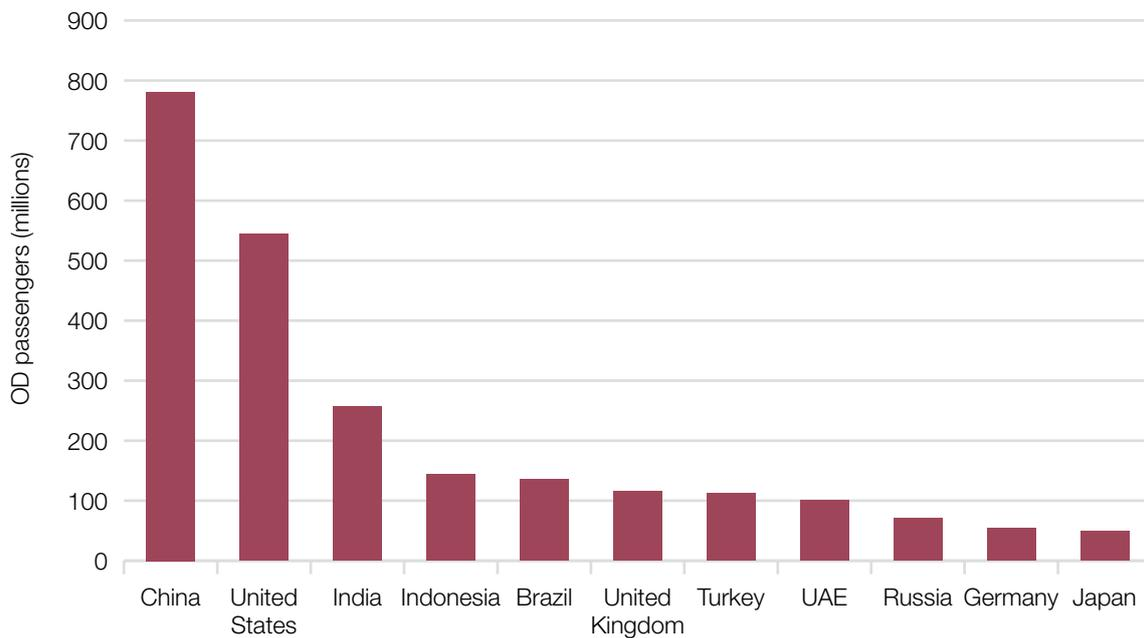

Source: IATA, *Tourism Economics, 'Air Passenger Forecasts'*

- 2.33** With rapidly growing demand from emerging-market economies and ambitious strategies to compete with European legacy carriers from their airlines, it is likely that many spokes from their hubs will point in the direction of Europe, including the UK. Once again, however, these connections would mainly be focused on the thickest and most profitable routes between the UK and these regions, suggesting that it is doubtful that this will lead to many more marginal routes being established.
- 2.34** For those reasons, while low-cost long-haul operations and services from emerging-market economies are likely to expand, these developments would not be expected to have a significant impact on the availability of a wider range of direct long-haul routes.
- 2.35** The broader global trends of consolidation and increasing competition outlined earlier may be expected to continue although the pace is uncertain. These trends have had a substantial influence on the shape of the UK airports sector over recent decades. It is also clear that the demand for landing slots in London and the South East of England will continue to grow.

The UK airport system

- 2.36** To determine the UK's airport capacity needs, the Commission's starting point was to consider the performance of the UK aviation sector in providing services to the users of aviation: the connectivity it provides, its strengths and weaknesses and the reasons behind them. The Commission also considered the impact of the UK's climate change legislation.
- 2.37** As explained in the *Interim Report*, the UK aviation market is served by a diverse system of airports, from a global aviation hub at Heathrow through large scale point-to-point airports, such as Manchester, Birmingham and Gatwick, down to small airports primarily focusing on maintaining lifeline routes, for example in the Highlands and Islands. There are also important freighter operations at Stansted and East Midlands, and bellyhold freight services are provided from other locations, of which Heathrow is by some distance the most significant.
- 2.38** Passenger demand and connectivity are highly concentrated on the four largest airports: Heathrow, Gatwick, Manchester and Stansted, which accounted for over 60% of passengers served last year and each served more than 140 destinations weekly, compared to fewer than 100 at any other airport.
- 2.39** The fact that three of these four airports are close to the capital indicates the central role played by the London system in supporting UK connectivity. As shown in **Figure 2.5** below, London benefits from the biggest and strongest aviation market in global air transport, reaching close to 110 million OD passengers in 2012. This supports a greater level of connectivity across the airports in the region than is available at any other European city, and ensures that the UK benefits from connections to a wide range of developed and emerging market destinations.

Figure 2.5: London still retains the biggest OD market in the world

20 biggest OD markets in the world in 2002, 2002 and 2012 figures

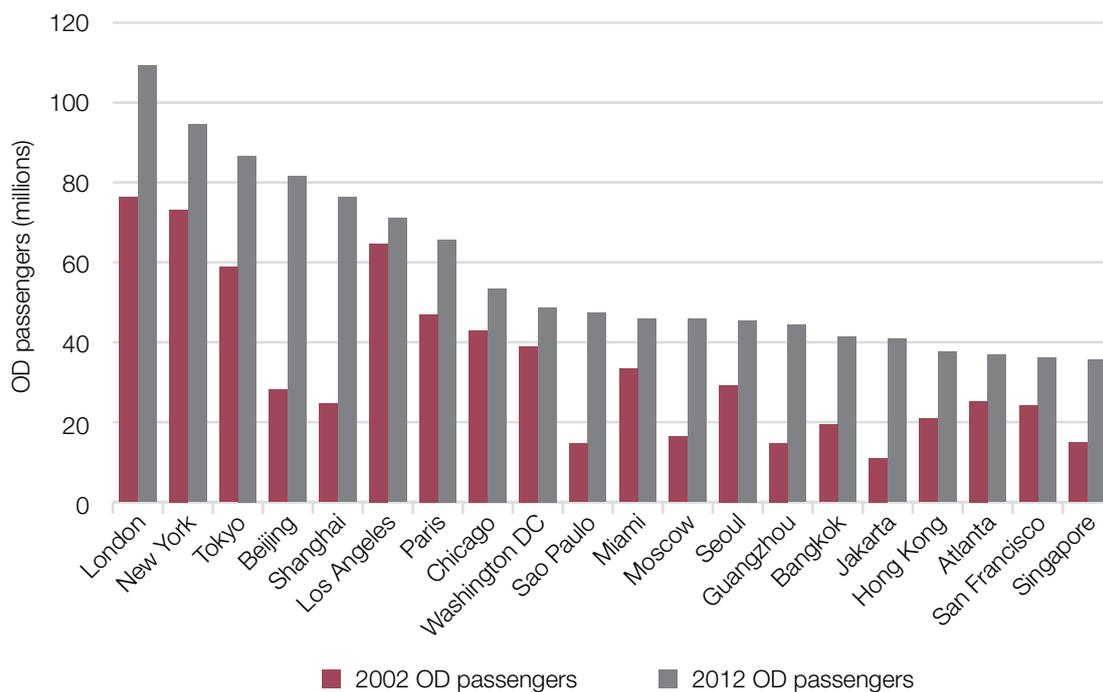

Source: PwC analysis based on Sabre ADI

2.40 The concentration of aviation of services in London and the surrounding regions (South East and East of England) can be explained by a combination of factors: these are the most densely populated regions of the country, with nationally diverse populations, often dependent on air services to visit friends and family, and their economies are strongly reliant on service sectors which need effective air connectivity. These characteristics particularly apply to London, which is by any measure a truly global city with a constant influx of newcomers from many different parts of the world.

2.41 Some stakeholders criticised the Commission's focus on capacity in the London and the South East deeming it too 'London-centric'. The Commission strongly disagrees with that view. The strength of the London aviation system is crucial to the country as a whole. The UK's regional airports have an important role to play in the UK's overall connectivity, but there will remain many routes which require the depth of demand available in the London market to make them profitable or to support the frequency of service demanded by business travellers. Ensuring that the London system is able to provide this connectivity, and that it is accessible from every region of the country, will deliver benefits across the UK as a whole.

2.42 The UK airport system is also heavily privatised in comparison to those of most other countries. A number of airports, including several of the UK's largest, are fully in private ownership and others have substantial minority stakes held by private investors. This is particularly the case in the London system, where the break-up of BAA Ltd which began in 2009 has led to each of the city's largest airports being in separate majority ownership and all but one being entirely privately owned.¹³ This is driving significant investment, innovation and growth, as these airports compete on cost and quality of service. For example, both Gatwick and Stansted have made significant investments in their terminal facilities and agreed long-term deals with their major customers to increase the scale and frequency of their networks.

The role of Government in a privatised airport system

Private ownership means that airports do not rely on government funding to finance new infrastructure developments, or to support their operating costs, and they will therefore make the choice to finance and build additional capacity only when they are confident that that capacity will be utilised and provide a satisfactory rate of return for their investors.

It also means that airports control how they conduct their business and carry out their operations, although where these operations impact the public or taxpayer (for example, where they have environmental, safety and economic impacts on passengers and local communities), they must comply with regulations set by Government and enforced by the UK's independent aviation regulator the Civil Aviation Authority (CAA).

Nonetheless, although Government does not direct privately-owned airports on their operations and investment decisions, both national and local Government have important roles. They are responsible for deciding overall policy for aviation and carrying out negotiations at international level (both bilaterally and in fora such as the International Civil Aviation Organisation), delivering the surface transport infrastructure on which airports rely, determining how they should engage with their local communities, and establishing emissions targets and restrictions.

13 The exception is Luton Airport which is owned by Luton Borough Council but operated by a private sector company on a long-term concession.

Central Government also has a crucial role to play when planning powers are sought for the delivery of any major new airport development. The 2008 Planning Act requires that any planning application for large-scale airport infrastructure go through the system of development consent for Nationally Significant Infrastructure Projects (NSIPs). Under this system, planning applications for NSIPs are examined by the Planning Inspectorate, in the context of a National Policy Statement set by Government. This sets out the Government's objectives for the development of aviation infrastructure and the criteria to be taken into account in considering locations for development, and explains the reasons for its policy, including an explanation of how it takes account of climate change. Once it has considered any application, the Planning Inspectorate then makes recommendations to Ministers, who must take the decision as to whether consent should be granted.

The alternative route to securing powers for the construction of major new aviation infrastructure would be through a Hybrid Bill. This has been used over recent decades for the Channel Tunnel Rail Link and Crossrail and is currently the route being followed to seek powers for the construction of the first phase of HS2. The role of government in this instance would be still more significant, because it would need to lead the process of seeking powers in Parliament. The options for securing powers for new airports infrastructure are discussed in more detail in **Chapter 16**.

- 2.43** The UK aviation sector has responded successfully to the growth in demand for aviation, which has tracked GDP growth closely over the past 50 years, as shown in **Figure 2.6** below. On the one hand, Heathrow's role as the UK's major hub airport has been strengthened, together with its dominance in the long-haul market. On the other, a burgeoning low-cost sector has seen new bases established at a number of other UK airports, the largest at Gatwick, and the European and Middle Eastern hub carriers are providing rising numbers of connections to airports across the UK.

Figure 2.6: Historically, passenger demand for aviation has risen in line with or faster than GDP since 1960

Terminal passengers at UK airports and GDP, 1960-2014

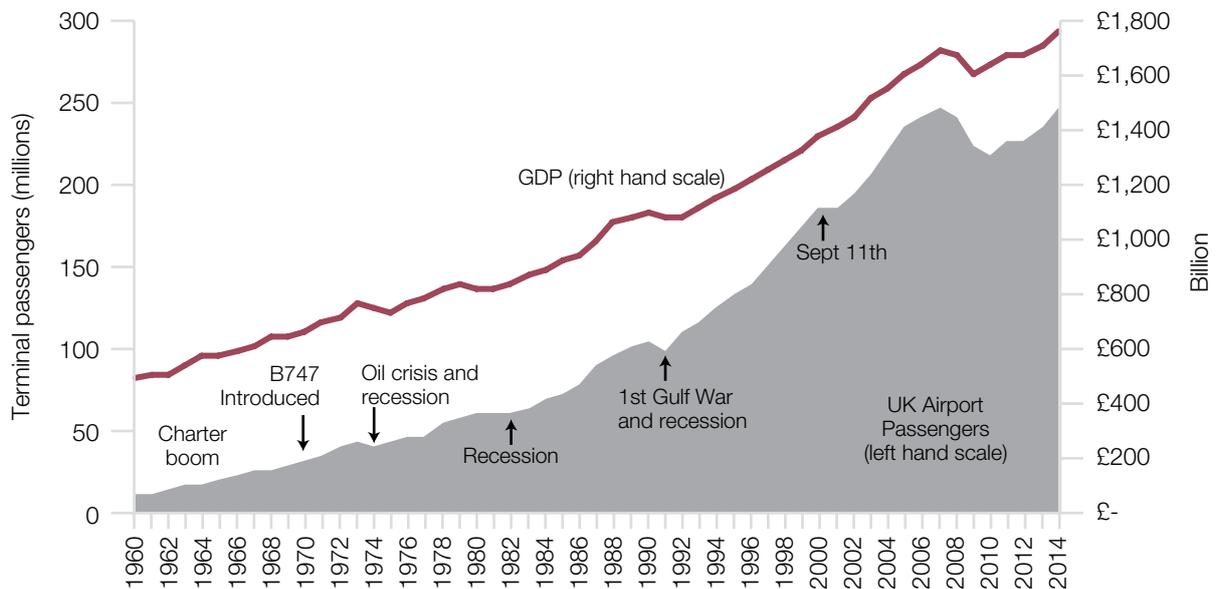

Source: DfT analysis based on CAA statistics and ONS data

2.44 The liberalisation of the market for air services between the EU and US played an important part in reinforcing Heathrow's position as the country's major long-haul airport. Until that point, a maximum of two US carriers were permitted to operate from Heathrow, but once those rules were relaxed four further US airlines moved their services there. As Heathrow's strength has increased, other carriers have moved services from Gatwick as slots became available. They are drawn by the scale of the market and high yields available from the airport, and as each alliance has seen the number of services at the airport grow, they have been incentivised to invest in improved facilities, concentrated in each case on a single terminal, which has further entrenched this pattern.

2.45 This means that the level of competition for long-haul services in the London airports system is lower than might be expected when looking solely at the catchment areas of the six London airports. These significantly overlap when looking solely at access times, which would suggest that there should be substantial potential for competition in the London airport system (see **Figure 2.7**).

Figure 2.7: The catchment area suggests there is potential for competition between the London airports, but it is more limited for long-haul services

Overlap of London airport catchment areas, 90 minutes access time by road or rail, 2011

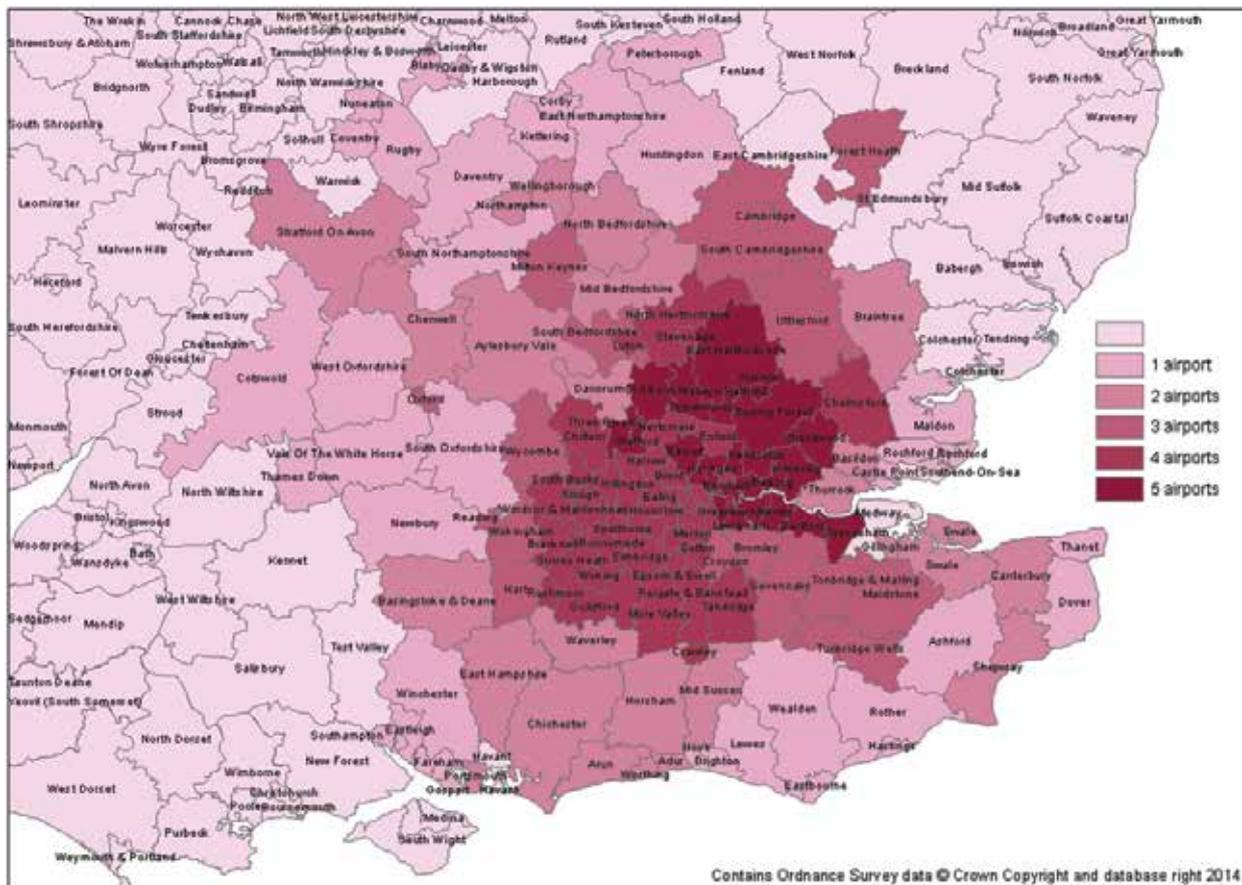

Source: Airports Commission adaptation of CAA airport statistics

2.46 In practice, however, Heathrow’s long-haul network over-shadows that of any other UK airport, with 84% of scheduled long-haul flights at London airports and 60% of scheduled long-haul destinations not being available anywhere else in the London airport system. Gatwick is the UK’s second largest long-haul airport, but offers only 14% of the scheduled flights. Its long-haul network is aimed largely at the leisure market, with a focus on destinations such as the Caribbean, Florida and North Africa, as can be seen in **Figure 2.8**.¹⁴

14 International Transport Forum (November 2014), Expanding Airport Capacity: Competition And Connectivity, <http://www.internationaltransportforum.org/Pub/pdf/14Airports.pdf>

Figure 2.8: For intercontinental travel, there is no real alternative to Heathrow, particularly for travellers who value high frequencies of connections

Destinations outside of Europe with at least a daily service from Heathrow, Gatwick or both, 2014¹⁵

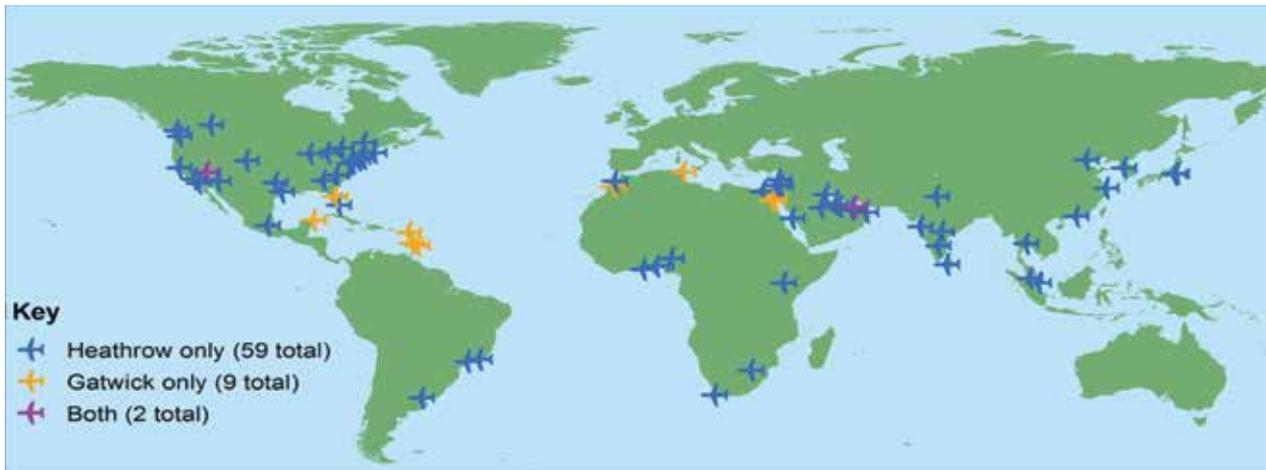

Source: DfT analysis of CAA airport statistics

- 2.47** Gatwick also provides lower average frequencies than Heathrow; only 11 routes outside Europe are served daily from Gatwick. Higher frequencies of service are particularly important to business travellers as they reduce waiting times and allow more flexible travelling schedules.
- 2.48** Over recent years, Gatwick has sought to compete more fully with Heathrow in this market, attracting a major Middle Eastern carrier and the UK's first low-cost long-haul services. They have, however, tended to replicate routes from Heathrow rather than increase the overall network. It has also accommodated flights from long-haul carriers unable to access slots at Heathrow, including from emerging markets, but they have often relocated as slots have become available, with most recently Vietnam Airlines moving its services to Heathrow in late 2014.
- 2.49** Other London airports do not currently compete significantly in the market for long-haul travel. Stansted and Luton offer only 46 long-haul flights a week, which are almost exclusively leisure services to the Caribbean and North Africa. London City Airport's only long-haul service is an all-business-class, narrow body link to New York, via Shannon on the westward leg.

¹⁵ Daily service: at least 361 passenger flight departures a year.

2.50 The picture is fundamentally different in the short-haul market, where there is much more scope to establish connections from any of the capital's airports. As a result, they compete strongly for routes and passengers. Furthermore, a wide range of low-cost carriers have been attracted to London's airports, driven by London's attractiveness to inbound carriers and the scale of its home market, which has increased the capital's short-haul route network and the level of competition within it still further.

Figure 2.9: The London market for short-haul travel is much more competitive than the long-haul market¹⁶

% of flights in the London airport system split by airport, 2013

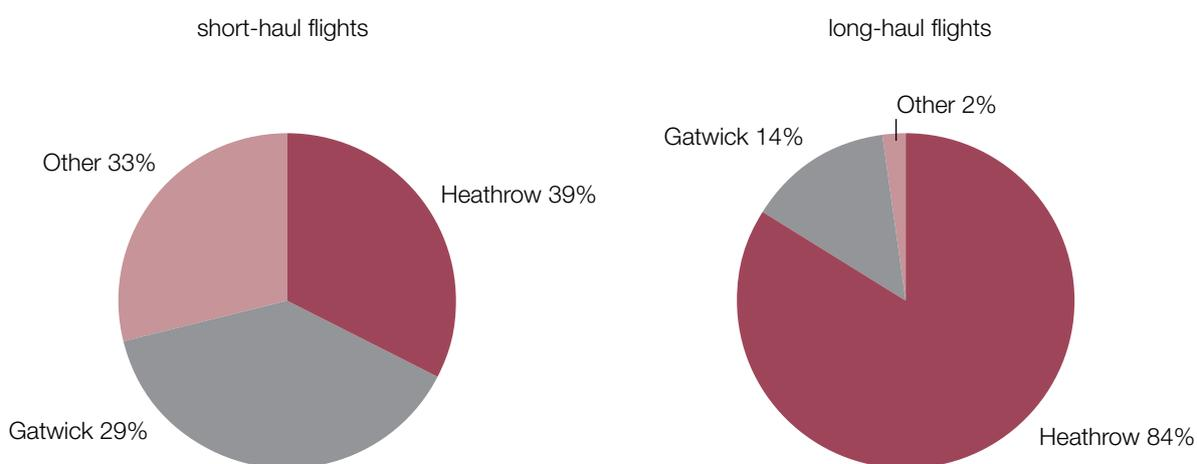

Source: Airports Commission analysis

2.51 Short-haul connectivity is much more evenly distributed than long-haul across the London airports, with Heathrow having a much less dominant market share of about 39% of all scheduled short-haul flights, followed by Gatwick with a 29% market share as seen in **Figure 2.9** above. The other London airports together take a market share of around 33%. In terms of the higher yield segment of premium short-haul flights, however, Heathrow and City capture the majority of the market. Gatwick, with a 44% market share, dominates the short-haul low-cost market. Its domination is even greater in the short- and medium-haul charter services (74%). Gatwick, unlike other low-cost London airports, attracts some more upmarket short-haul routes, served mostly by British Airways (about 600 flights a week). The other London airports, Luton, Stansted and Southend, focus nearly exclusively on the lower yield segment served by low-cost and charter carriers.

¹⁶ Excludes Southend. This chart uses ITF definitions of long-haul and short-haul (see glossary).

2.52 The growth of the low-cost sector has also boosted the UK's regional airports, which expanded rapidly in the 1990s and early 2000s, growing as a group at a rate of between 5-12% for each year between 1997 and 2005. During that period many regional airports grew in status and importance, attracting more passengers and airlines and serving a wider range of destinations. For many UK passengers, the option of travelling from their local airport – rather than travelling to London to take a flight – became realistic for the first time.

2.53 As set out in *Discussion Paper 6: Utilisation of the UK's Existing Capacity*, the strong growth in regional airport traffic became less uniform towards the end of the 2000s and since 2007. The UK's larger regional airports continued to grow their passenger numbers and route networks, whilst the small and medium sized regional airports have seen them plateau or decline. One reason for the continued growth of the larger airports is the long-haul connectivity they increasingly provide, particularly via direct services to hubs in the Middle East. As these (and other) long-haul services have become more established, the airports offering those routes have in turn attracted more short-haul domestic transfer traffic, a pattern of growth that shows no sign of abating.

The performance of the UK airport sector

2.54 The impact of these trends has been to ensure that the UK airports sector continues to perform strongly as seen in **Figure 2.10**. UK airports currently offer more destinations and a greater number of seats than any other European country, and the London market continues to offer more capacity than any other major city.

Figure 2.10: The UK has more seats available and serves more destinations on a daily basis than any other European country

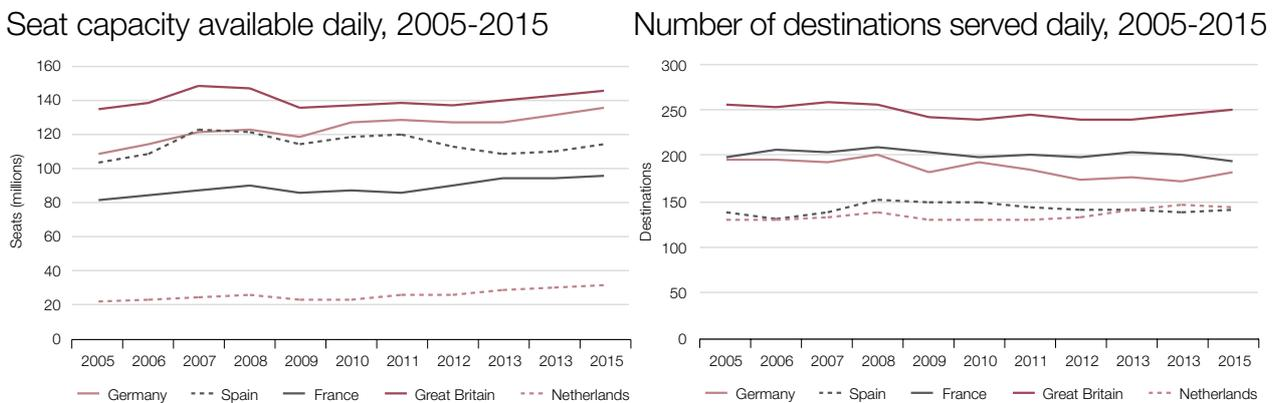

Source: CAA analysis based on OAG data

2.55 In part this reflects the historic and continuing attractiveness of the UK and London as destinations. But the UK has also maintained an important position in the network of global connections, which has allowed it to benefit from a richer set of aviation links supported by transfer traffic than could be sustained by origin-and-destination passengers alone. Overall, the UK currently benefits from the world's third largest route network, with particularly strong connections to Europe and North America (see **Figure 2.11**).

Figure 2.11: The majority of international traffic from the UK is to Europe and North America

International passenger movements at UK airports, 2004-2014

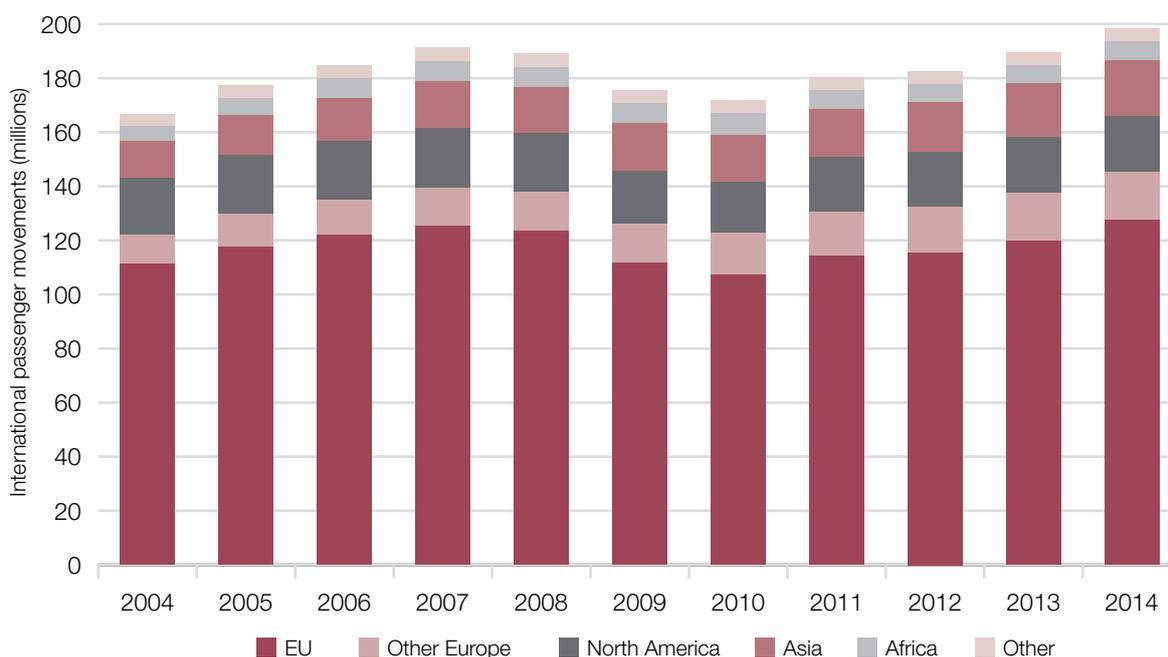

Source: DfT analysis of CAA airport statistics

2.56 The UK's largest airports are, however, increasingly constrained. Significant investment in terminal infrastructure has taken place over recent decades, including the Southern Terminal at Gatwick and Terminals 2 and 5 at Heathrow, but the only new runways to open since 1945 have been at Manchester and London City. Both Gatwick and Heathrow have responded positively to this challenge and as demand has grown they have increased the efficiency with which their runways are used, to the point that they manage significantly more air transport movements than any comparable one- or two-runway airports in the world.

2.57 Even allowing for these improvements, however, Heathrow is effectively full, having been operating for several years right at the edge of its planning cap of 480,000 movements per annum, which represents the maximum achievable capacity from two runways operating in segregated mode, with restrictions on night time flying. Although not as constrained as Heathrow, Gatwick is operating at over 85%

capacity already and is forecast to reach the limits of what its runway can accommodate within a few years. Other London airports are forecast to become full over the coming decades but retain spare capacity currently, although this is generally limited in peak hours.

2.58 The consequence is that the London system outperforms its peers in the short-haul market, where greater capacity is available and competition continues to drive significant growth, but that its long-haul network is less extensive than might be expected, given the scale of the London aviation market.

2.59 If capacity remains constrained, the system's ability to accommodate growth in long-haul services will be limited, with any new routes likely to come at the expense of existing services. Long-haul carriers may continue to establish new connections from regional airports, and may begin to make use of the capacity at London airports other than Heathrow and Gatwick. While potentially of significant value to regional and more price sensitive passengers, these links are most likely, however, to be focused on increasing capacity on the thickest routes rather than expanding the overall network to new markets. Even in the short-haul market, as a wider group of airports reaches capacity, the system's ability to sustain this strong performance may weaken.

Any change to UK's aviation capacity would have to take place in the context of global climate change, and the UK's policy obligations in this area

2.60 As well as reviewing the performance of the UK airports system, the Commission has incorporated the Committee on Climate Change's (CCC) advice on climate change emissions from aviation at the centre of its analysis of the need for new capacity.

2.61 Even though aviation currently accounts for less than 7% of the UK's overall CO₂ emissions, air travel has an extremely high carbon cost compared to other sources: flying one passenger from London to New York and back generates roughly the same level of CO₂ emissions as the average person in the EU does by heating their home for a whole year. In light of rising standards of living and with limiting policies currently in place to reduce carbon emissions from aviation, the sector's share of the UK's overall carbon emissions has been increasing, as demonstrated in **Figure 2.12**, and is expected to rise even further in the coming years.

Figure 2.12: UK carbon emissions from aviation have almost doubled since 1990

UK carbon emissions from aviation, MtCO₂(e) and as % of total UK carbon emissions, 1990-2013

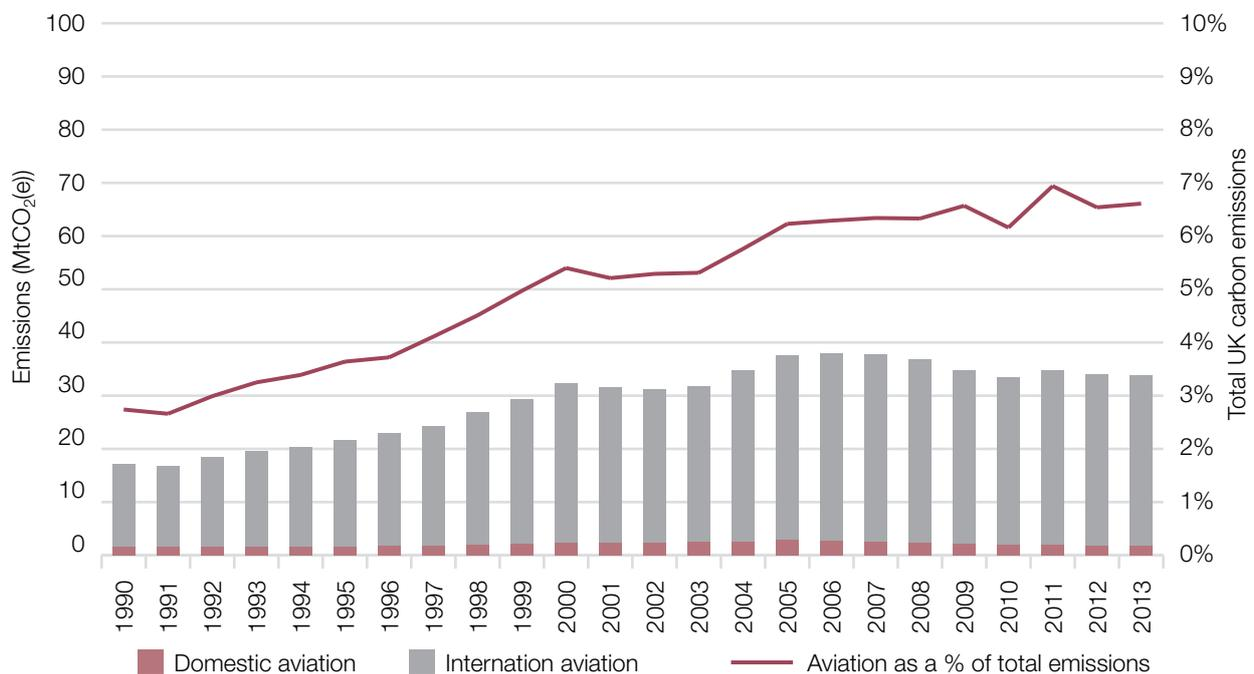

Source: National Atmospheric Emissions Inventory

- 2.62** The UK’s Climate Change Act of 2008 sets a legally binding target to reduce overall UK emissions by at least 80% below 1990 levels by 2050.
- 2.63** The CCC, which was established by the Climate Change Act 2008, has a responsibility to set and monitor carbon budgets. As part of its work, it has identified a planning assumption for aviation emissions which is consistent with the UK’s overall targets, but which also recognises aviation’s value to the economy and society and the particular challenges of decarbonising in the sector.
- 2.64** The CCC’s planning assumption requires that gross CO₂ emissions from UK aviation in 2050 should not exceed 37.5Mt, the level seen in 2005. On that basis, the economy-wide target of reducing emissions by 80% below 1990 levels could be achieved through other sectors reducing their emissions by around 85% on average. The CCC considers that a realistic but ambitious goal, at the upper end of what is currently expected to be deliverable.

- 2.65** The CCC's view is that the planning assumption is best achieved through international measures. That is also the policy of the UK Government, which supported the inclusion of international aviation in the EU Emissions Trading System (EU ETS) in 2012 and is currently participating in negotiations to agree a global market-based measure to tackle aviation emissions, through carbon trading and offsetting, in the International Civil Aviation Organization (ICAO). The ICAO General Assembly agreed to develop such a measure in 2013, and asked the Council to develop a proposal capable of being implemented from 2020, for decision by the next General Assembly in 2016.
- 2.66** To support the negotiations at ICAO, the European Parliament has suspended enforcement of ETS obligations on flights between European airports and the rest of the world under a "stop the clock" agreement. This will continue with only intra-European Economic Area flights being covered by the EU ETS until 2017, when progress at ICAO's 2016 General Assembly will be assessed to determine if the enforcement of ETS obligations should be recommenced for all flights.
- 2.67** If an international deal cannot be struck (whether EU or global), UK-specific measures may be needed to ensure that aviation makes an appropriate contribution to the UK's overall carbon reduction goals.
- 2.68** To understand the implications of the UK's climate change obligations for its analysis of the need and options for additional aviation capacity in the UK, the Commission has integrated the CCC's planning assumption into its approach to forecasting aviation demand. It has developed two sets of forecasts, one assuming that emission reductions will be made where they are most desirable or efficient across the global economy, which is described as a carbon-traded scenario, and one with a firm aviation emissions cap in place of 37.5 MtCO₂. The forecasts are discussed in greater detail in **Chapter 3**.
- 2.69** Reducing carbon emissions is not the only international environmental policy issue assessed by the Commission. In addition there are a number of important national, European and international legislative targets for reducing air quality emissions and protecting habitats. They are discussed in **Chapter 8**.

3. The Case for Change

3.1 This Chapter presents the Commission’s analysis of the importance of aviation capacity to the UK economy and of the costs of the current capacity constraints to the UK’s residents and businesses. It also provides an overview of the Commission’s assessment in its *Interim Report* that the only way effectively to tackle these challenges is through building one net additional runway in the South East by 2030.¹⁷

A thriving aviation sector is very important to the UK’s residents and businesses

3.2 Very few people take flights for their own sake. Demand for aviation is ultimately driven by a need or desire to do other things – to win business through meeting clients or suppliers face-to-face, to see friends and family or to enjoy a holiday abroad. Connectivity is about making these activities as easy as possible.

3.3 The importance of aviation to UK residents and businesses is reflected in the fact that about half of the British population travelled by air over the past twelve months.¹⁸

Air connectivity is important to supporting leisure activities

3.4 Leisure travel is a critical component of the UK aviation market. **Figure 3.1** illustrates the scale of travel for holidays and for visiting friends and relatives (VFR) from the UK’s five largest airports. More than three times as many passengers take flights for leisure as fly on business.

¹⁷ Interim Report, Chapter 4,

www.gov.uk/government/publications/airports-commission-interim-report

¹⁸ <http://www.ons.gov.uk/ons/rel/ott/travel-trends/2013/rpt-travel-trends--2013.html#tab-Data-tables-associated-with-this-report>

Figure 3.1: Over three quarters of international passengers at the five biggest UK airports travel for leisure purposes

International passengers at the five biggest UK airports by purpose, 2000-2013

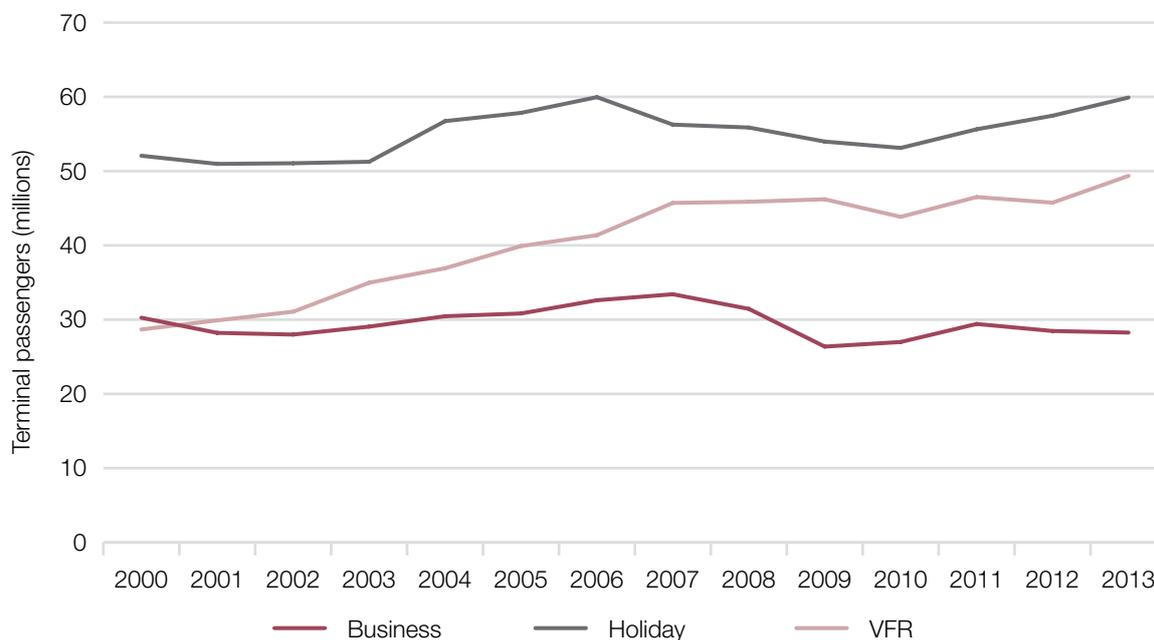

Source: DfT analysis of CAA passenger survey

- 3.5** Leisure flights have a high social value. Empirical analysis focused on passengers travelling on holiday or to visit friends and family has shown how the access to leisure travel affects mental health and wellbeing. The findings demonstrate these patterns of travel are associated with higher levels of life satisfaction, general and mental health, and happiness.¹⁹
- 3.6** Leisure travel is also of significant importance for the UK economy. Multi-national businesses operating in the UK recruit from a global pool of talent in IT, creative industries, financial services, advanced engineering and many other sectors. For their personnel the ability to return home easily to visit parents and even children is not a luxury, it is an important part of the package that persuades them to take a job in the UK. The same considerations apply to UK businesses posting staff to important overseas markets. The ability to travel home affordably and conveniently is not just a social benefit, it makes a material contribution to the competitiveness of the UK.
- 3.7** In addition, the UK's overall connectivity depends on leisure traffic. Passengers may be categorised according to the purpose of their journey but flights cannot. Most flights are made up of a mix of passengers travelling for business, for leisure and to

¹⁹ The full analysis of this topic can be found in the report *Quality of Life: Leisure Impacts Assessment*, published alongside the Commission's consultation and in a further report, *Quality of Life: Further Assessment* published alongside this report.

visit friends and family. The viability of the flight or route is dependent upon a balance of all three categories. For example low-cost flights in Europe will nearly always carry a number of passengers travelling for business, and flights from Heathrow to New York will be carrying passengers going on holiday as well as those travelling for work. Indeed, whilst Heathrow is noted for being the UK's premier airport for business travellers, they are still outnumbered by leisure passengers at the airport. By providing a steady stream of demand across the full range of connections served from the UK, leisure travellers help to maintain the density of its route network and therefore the connectivity that its businesses require to compete globally.

- 3.8** The largest industry associated with leisure flights is tourism. The UK has a significant tourism sector which contributes both employment and gross value added to the economy. In 2013 the Tourism Direct Gross Value Added was £56 billion²⁰ while the most up to date value of inbound tourism is £21.8 billion in 2014.²¹ The wider UK tourism industry is forecast to grow significantly over the coming decades but of particular relevance to Commission's analysis is the growing propensity to travel of a rapidly expanding middle class in many developing economies, particularly in Asia. This is a significant opportunity for the UK's tourism as well as London as a global city with a strong history and an established tourist infrastructure which has great potential to be the starting point for European travel.

Air connectivity is crucial to supporting the UK businesses and the wider economy

- 3.9** Aviation connectivity contributes to the success of UK business in several different ways. It facilitates the movement of services and goods, workers and tourists, and drives business innovation and investment. In doing so, aviation generates employment and helps to improve the productivity of the wider UK economy.
- 3.10** The UK's strong services sector, which provides significant export earnings for the country, is particularly reliant on aviation. The sector includes, among others, financial services, insurance, creative industries, education, and health – all of which rely on face-to-face engagement with customers for success. The importance of air connectivity to the service sector is reflected in the high expenditure of the sector on aviation and the strong correlation between the level of services provided from the UK's major airports to particular destinations and the value of exports to those places. Although connectivity alone is insufficient to create trade as other factors are important (e.g. the UK's competitiveness in the global markets, trade deals, visa

20 http://www.ons.gov.uk/ons/dcp171776_386386.pdf

21 <http://www.visitbritain.org/2014-snapshot>

regimes), without it new trade opportunities will not materialise. As business passengers are usually very time-sensitive, they particularly value direct connections, high frequencies and reliability of service and quick links to the airport.

- 3.11** Aviation connectivity also supports the UK economy in other ways. It drives productivity and is an important factor in business innovation and investment. For example studies and surveys confirm that international transport links influence decisions by companies on where to locate their headquarters, as can be seen from the significant technology cluster based close to Heathrow in the Thames Valley. There is also evidence to show that connectivity is an important factor in firms' investment decisions.²²
- 3.12** In the future, with the global economy's centre of gravity moving eastward, pulled by the rapidly growing economies of South and East Asia, and global supply chains becoming more complex, air connections will be even more important in establishing access to important import and export markets for UK's firms. By 2030 advanced manufacturing industries such as pharmaceuticals or chemicals, whose components and products are predominately moved by air, are expected to be among the top 5 UK export markets by their share of value.²³
- 3.13** More direct routes, higher frequencies of service and lower fares have beneficial impacts on businesses by providing time savings and facilitating important connections to export markets. Greater connectivity enables more efficient logistics for the transport of goods and fosters productivity by providing manufacturers with new business opportunities and opportunities to cut costs. It also delivers a greater variety of goods to consumers by integrating the UK into global supply chains.
- 3.14** Moreover, aviation provides new jobs which are on average more productive than in the rest of the economy. This higher labour productivity in turn creates positive spillovers – workers in the aviation sector spend more and pay more tax to the Exchequer.
- 3.15** The Airports Commission's Spatial Computable General Equilibrium (S-CGE) analysis, which is described in **Chapter 6**, shows that expansion at either Heathrow or Gatwick would have a significant positive impact on the air passenger transport and freight sector, which would be up to 15% larger in 2050 than if expansion does not take place.

22 For example, see European Cities Monitor 2011 by Cushman and Wakefield: <http://www.cushmanwakefield.com/~media/reports/uk/Brochures/European%20Cities%20Monitor%20October%202011.pdf>.

23 <https://globalconnections.hsbc.com/global/en/tools-data/trade-forecast-tool/uk#>

3.16 As well as facilitating the success of the UK services sector, aviation supports British manufacturing, carrying high value exports, particularly to emerging markets, and helping to secure the position of UK based manufacturers in complex global supply chains. Today around 40% of the UK's trade with economies outside the EU by value is transported by air and in 2014 alone, the total value of tradable goods carried through UK airports exceeded £140 billion.²⁴

3.17 Air freight also contributes to maintaining the diversity of the UK route network. The revenue from freight carried in the cargo hold of passenger aircraft can make viable a route which would not be if carrying passengers alone. The majority of air freight to and from the UK is carried in the cargo hold of passenger aircraft. As a result Heathrow is by far the largest and most important UK airport for freight (see **Figure 3.2**).

Figure 3.2: Heathrow dominates the UK air freight market

Top five airports for freight value, 2014

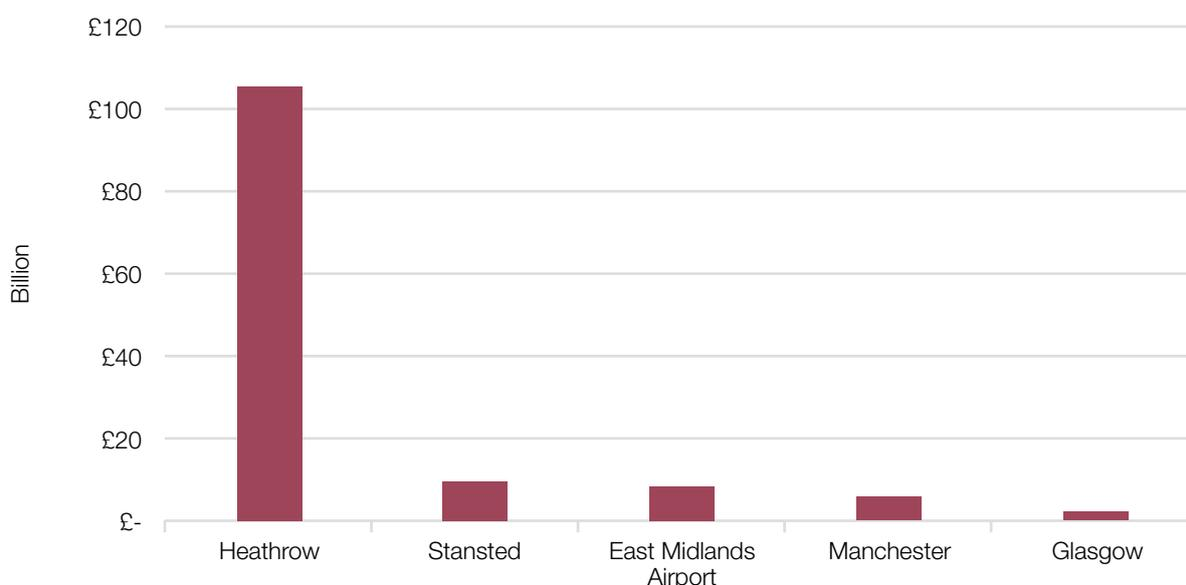

Source: Airports Commission analysis

3.18 Historically the growth of passenger demand has been accompanied by growth in demand for air freight, with numbers of UK passengers growing by a compound average rate of 3.6% between 1990 and 2012 and volumes of UK air freight increasing by 2.9% over the same period. Industry projections show that the strongest growth for freight in the developed world is expected to be with emerging economies, emphasising the continuing importance of the role of Heathrow Airport as the UK's most important freight hub.²⁵

²⁴ HMRC data

²⁵ Airbus (2013), Global Market Forecast: Future Journeys 2013-2032, http://www.airbus.com/company/market/forecast/?eID=dam_frontend_push&docID=33755

How air freight works

Air freight is generally used to ship goods that are relatively small and high value and in markets where goods need to be shipped over long distances quickly and surface transport options are limited. Examples include food or pharmaceuticals that need to be delivered in controlled environments with short shelf lives and fast evolving high tech products where several weeks of sea transit to or from the Far East might represent a significant proportion of the product's sales life.

Air freight is either carried by dedicated freighter aircraft or in the cargo holds of passenger services – known as bellyhold freight. Freighter aircraft are predominantly flown between freight hubs in an operator's distribution network where volumes are sufficient to justify the expense of running dedicated cargo services. Bellyhold freight uses passenger services to expand the potential freight network. The extra time involved in ground handling freight means that such bellyhold operations have traditionally not been used in the short-haul low-cost sector where operators focus on reducing turnaround times and maximising the number of flights each aircraft makes in a day. easyJet trialled the carriage of cargo in Europe in 2012 but the operational challenges (e.g. time taken for security processes) led it to discontinue the service.

The time of day when capacity is available is also of critical importance to air freight companies as it determines the levels of service that they can provide their customers.

Due in part to the capacity for road and rail transport to compete with airfreight on time over distances of up to 400-500km, air freight tends to be focused on inter-continental long-haul destinations.

3.19 Finally, airlines and airports themselves directly generate economic output and employment. In 2013, the whole annual UK air transport sector's turnover was around £32 billion and it produced around £12 billion of economic output. The sector employs about 116,000 workers directly and supports many more indirectly.²⁶ It also provides a valuable source of Government revenue through the collection of Air Passenger Duty (APD), which raised over £3 billion in the 2013-14 financial year.²⁷

3.20 In summary, the UK benefits considerably from high connectivity, driven in large part by London's status as the largest origin and destination market in the world.

²⁶ <http://www.ons.gov.uk/ons/publications/re-reference-tables.html?edition=tcm%3A77-341896>

²⁷ <https://www.uktradeinfo.com/Statistics/StatisticalBulletins/Pages/BulletinArchive.aspx?viewname=Air+Passenger+Duty+Archive>

Aviation is a significant contributor to the UK economy through facilitating trade in goods and services, making the UK an attractive place for firms to locate their businesses and through driving growth in the leisure and tourism sector. In addition the UK derives significant social benefits from providing its citizens with a wide range of holiday destinations and opportunities to visit family and friends abroad.

But problems are starting to emerge

- 3.21** While the UK aviation sector provides its users with excellent connectivity, the negative effects of failing to address the capacity constraints at airports, particularly at Heathrow and Gatwick, will rise sharply if nothing is done. In London and the South East Heathrow has been effectively full for many years, and Gatwick is operating at more than 85% capacity and is completely full at peak times. This makes it more and more difficult for airlines to operate efficiently from these airports, particularly long-haul carriers who are reliant on the high volumes of demand that can only be achieved at the country's biggest airports.
- 3.22** Capacity constraints are increasingly affecting the nation's ability to travel cheaply, conveniently and to a broad range of destinations through impacts on delays and unreliability, competition and fare levels, domestic and international connectivity, the UK's hub status, and, as a result, the wider economy.

Resilience and delays

- 3.23** One of the most significant impacts of operating infrastructure close to its limits is a reduction in its ability to recover from unforeseen disruptions. At airports, these may arise due to airline behaviour or other exogenous factors, such as adverse weather conditions. The adverse impacts of constrained capacity are particularly visible at Heathrow, where a CAA study found that during the period from April 2007 until March 2008, the airport suffered from 60 days when traffic could not fully recover from disruptions at the airport.²⁸ Over the same period Gatwick suffered no such incidents, in part due to the ability of Gatwick to use its spare capacity to recover from delays. With time, however, Gatwick's ability to do so will also become increasingly limited.
- 3.24** The impacts of expansion on delays and unreliability can be substantial. After its fourth runway opened in 2011, Frankfurt Airport saw its on-time arrival performance rise by 14%, and the following year its on-time performance rose above 80% for the first time since before 1997.

28 CAA, UK Runway Resilience Study: Final Report, http://www.caa.co.uk/docs/589/ICF_runway_resilience_final_report_16Feb09.pdf

3.25 Delays, cancellations and unreliability cause frustrations and take time that could be otherwise used more enjoyably or productively. They also have direct economic impacts on airlines and their passengers, which can feed through to the whole economy, damaging productivity as more and more time is wasted in making allowances in schedules for potential disruption. They can also lead to adverse environmental outcomes as aircraft are held in the air waiting to be able to land. At Heathrow, resilience issues affect local communities by reducing respite or changing its pattern. Analysis conducted by the Commission for its *Interim Report* suggested the cost of delays from capacity constraints could amount to about £5.1 billion between 2021 and 2080.²⁹

Competition and fare levels

3.26 Airport capacity constraints affect the extent to which airlines can serve demand and create significant barriers to entry for new players, putting significant pressure on the level of fares. With rising demand pressures over the coming decades, fares can be expected to rise even higher. This particularly affects the long-haul market as it is highly concentrated at the most constrained airports, Heathrow and Gatwick, (see **Chapter 2** for details).

3.27 The *Interim Report* cited analysis which indicated that fares at constrained airports in the UK could be approximately 10% higher than at airports without such pressures on capacity. Subsequent work by the Commission has suggested that, without new capacity, the costs of air travel would be forecast to rise on average by about £7-9 per passenger in the UK and by about £14-19 in London by 2050 (in 2014 prices), due to the inconvenience to many passengers of having to travel through a less convenient airport or via a longer indirect route. With constraints these additional costs would add up to as much as £3-4 billion by 2050.³⁰

Domestic connectivity

3.28 An important consequence of the airport capacity constraints in the UK is the apparent decline of domestic connectivity into the largest London airports and particularly into Heathrow (Figure 3.3). The number of domestic services into Gatwick, for example, has fallen by more than quarter since 2010, even as the overall number of flights from the airport has risen by 9% over the same period. Heathrow saw over 40,000 domestic flights in 1990 compared to just 23,000 in 2014.

29 PV, 2014 prices. Unless otherwise stated, all results presented here are for carbon-traded forecasts.

30 The estimate does not include the costs of delays due to capacity constraints.

3.29 A significant decline in the number of domestic routes into Heathrow has also been seen over recent years (see **Figure 3.3**). The Commission's forecasts predict that, unless capacity is expanded, this pattern will continue, with the number of destinations served from Heathrow declining to as few as three by 2040. The primary reason for this reduction in domestic connectivity at Heathrow is that, with practically all the airports slots taken up, many domestic destinations are priced out by long-haul routes that deliver higher yields per passenger.

Figure 3.3: The number of domestic connections into Heathrow has been declining

Number of UK destinations with a direct service into Heathrow, 1990-2014



Source: Airports Commission analysis

3.30 As emphasised by a number of stakeholders in their submissions, connections into Heathrow are very important for many of the UK's regions and nations of the UK for two main reasons.

3.31 First, they create links between the regions and London and the South East, fostering important business partnerships and links between UK residents. While other London airports provide the regions with useful links to the capital, they are not perfect substitutes for the links to Heathrow as the airport is more conveniently located with respect to important business centres such as the M4 corridor or the Thames Valley. This advantage will be reinforced when Crossrail opens in a few years' time.

- 3.32** Second, Heathrow remains a key access point for long-haul travel. With the decline of domestic connectivity, fewer passengers from the regions have the option of connecting through Heathrow. While a growing number of routes from regional and other London airports to overseas hubs has helped to offset this to some degree, those options cannot entirely compensate for a reduction in or loss of access to Heathrow's connectivity.
- 3.33** Also, the route networks of the major hubs do not entirely overlap, with Heathrow in particular offering high frequencies and a broad route network to countries that are of major importance to UK residents and businesses, notably North American destinations. These are unlikely to be replicated elsewhere and, even if they were, in many cases the journey would not be as convenient as it would require a time-consuming detour. Regional stakeholders have been clear in their representations to the Commission that while links to overseas hubs are highly valued, they are not considered a substitute for access to Heathrow.

International connectivity

- 3.34** Ensuring that the UK maintains globally competitive international connectivity is crucial to the economic wellbeing of the country. Trade in both goods and services is increasingly dependent upon the ability to access long-haul markets, particularly in Asia. To meet the needs of UK businesses adequate connections need to be available to attract high skilled workers from other markets.
- 3.35** Businesses in a global market and operations will continue to make connectivity a material consideration in where they invest. The long-term prosperity of the UK will be jeopardised if that connectivity is allowed to atrophy.
- 3.36** However, while the London system outperforms its peers in the short-haul market, capacity limits are having a constraining impact on the long-haul route network. The result is that long-haul connectivity at Heathrow is heavily focused on the most profitable routes, and the airport does not perform as strongly in terms of its links to emerging markets as might be expected, given the strength of the London market.
- 3.37** For its *Interim Report*, the Commission carried out a detailed review of the strength of the links to emerging markets from Heathrow compared to from other European hubs and from Dubai. This showed that it has comparatively strong links to India (reflecting the UK's historic ties), but the airport performs less well in terms of links to the other emerging economies (see **Figure 3.4**).

Figure 3.4: Heathrow is only an average performer in terms of its links to emerging markets

Number of direct, weekly destinations to a selection of emerging-market economies from European hubs and Dubai, 2005-2015

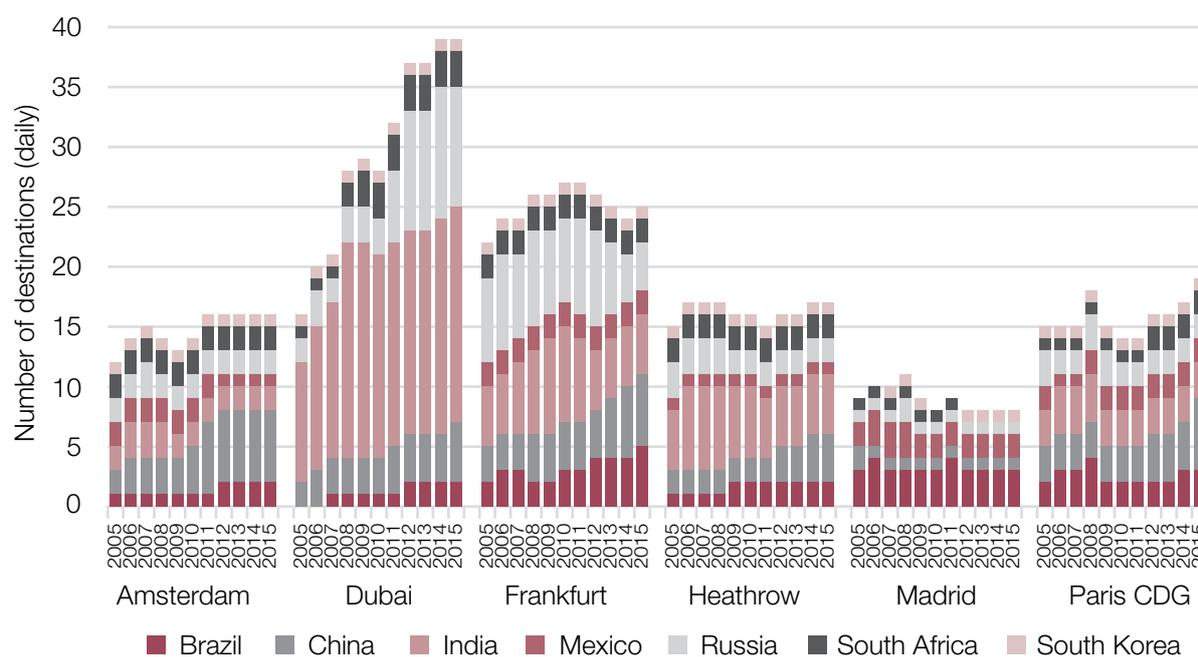

Source: Airports Commission analysis

3.38 To make a wider assessment of connectivity, the Commission developed a set of different connectivity metrics, for example by weighing available destinations according to the forecast future GDP growth to proxy their future economic importance.³¹ While Heathrow's overall connectivity was strong compared to other European hubs, this reflected in particular the strength of its North American and European connections. When these were excluded from the analysis, to focus on connectivity to emerging markets, Heathrow's performance fell to a similar level to that of its European peers, despite its much stronger home market and its frequent services to established destinations such as Hong Kong and Singapore and was significantly poorer than that of Dubai.

3.39 On this basis, in the Commission's view, a key objective for expansion should be to facilitate new connections on more marginal long-haul routes to emerging markets, without damaging the UK's excellent European and North American connectivity.

The UK's hub status

3.40 A key reason for the UK's underperformance in terms of its long-haul connectivity is the effect of runway capacity constraints in eroding Heathrow's status as an international hub.

31 PwC (December 2013), Airports Commission: Comparative connectivity analysis.

3.41 To be able to sustain many routes to emerging-market destinations and secondary North American cities, carriers at Heathrow need to attract international transfer traffic to supplement local demand for these destinations. That has been difficult in recent years.

3.42 First, declining domestic connectivity means that the airport is seeing fewer transfer passengers from the UK's nations and regions who would otherwise provide valuable feed to support long-haul routes. As can be seen from **Figure 3.5** below, the number of UK transfer passengers at Heathrow has declined since 2001, whereas the opposite has been seen at the other major European hubs particularly in Amsterdam, and at Dubai.

Figure 3.5: Increasing numbers of passengers from the regions are connecting through non-UK hubs

Estimated number of passengers flying from non-London UK airports to EU hubs and Dubai, 2001 and 2013

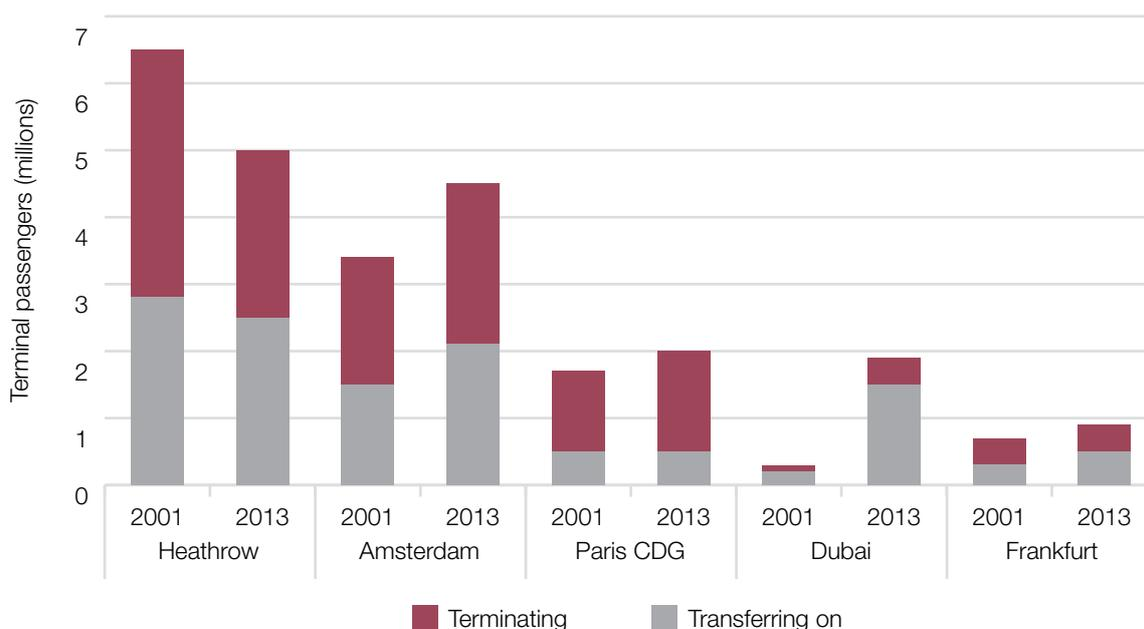

Source: Airports Commission analysis

3.43 Second, capacity constraints are putting pressure on fares at the hub airport, which will affect the price-sensitive transfer market, as international-to-international passengers often have several different options to reach their ultimate destinations.

3.44 Third, their choice of where to connect is likely to be further affected by the fact that the probability of suffering from resilience issues at Heathrow is higher than elsewhere due to its limited capacity to recover from adverse events.

- 3.45** Moreover, due to capacity constraints, carriers at Heathrow also have limited opportunities for having their slots arranged in optimal wave patterns to facilitate efficient hubbing.
- 3.46** Finally, due to capacity constraints at Heathrow, the airlines operating at the airport, in particular BA and its partners whose hub operation is based there, find it difficult to expand their current networks. Slots at Heathrow are very rarely available and therefore, whenever a new route is launched, it has to be at the expense of a different service which needs to be cancelled or replicated elsewhere.

Impacts on the wider economy

- 3.47** The consequences of capacity constraints outlined above also have negative impacts on the wider economy through creating barriers to trade, investment, tourism, and adversely affecting employment and productivity.
- 3.48** The Commission estimated the potential costs of failing to address capacity constraints in the *Interim Report* over a sixty-year time period to be £21-23 billion to users and providers of airport infrastructure and £30-45 billion to the wider economy. These wider economy impacts were based on an earlier version of the Commission's S-CGE approach, which considered fewer channels of how aviation impacts the wider economy. The Commission updated its approach for the assessment of the impacts of the short-listed schemes. The results are discussed in **Chapter 6**.

Building new capacity is the only real solution to a growing problem

- 3.49** The Commission undertook a significant programme of work to make an informed judgement about how much demand there is likely to be for UK airports between now and 2050. At the heart of this exercise was the DfT aviation demand model, which was adapted by the Commission in the light of responses to its *Aviation Demand Forecasting* discussion paper. Given the Commission's remit to maintain to the UK's status as Europe's most important aviation hub, a key update was to incorporate competition for transfer traffic between UK airports, other European hub airports and Dubai into the model.

3.50 In order to ensure that its analysis took account of the implications of the CCC's carbon emission planning assumption for aviation, the Commission considered the demand for aviation under two sets of forecasts, each of which represented a different approach to managing CO₂ emissions from aviation in the future:³²

- **Carbon-traded** – These forecasts assumed that carbon emissions from flights departing UK airports are traded at the European level until 2030 and then as part of a global carbon market. The carbon-traded forecasts incorporated DECC's central carbon price projections and assumed that the total emissions allowed beyond 2030 in the global market were set with reference to stabilisation targets and that society would seek to make reductions where they were most desirable or efficient across the global economy.
- **Carbon-capped** – These forecasts assumed the level of aviation demand could only grow in line with the CCC's current assessment of how UK climate change targets can most effectively be met. The carbon-capped forecasts assumed no trading of aviation emissions either within the UK economy or internationally, and increased the carbon price used in the model (as a proxy for any broader policy framework) to ensure that total UK carbon emissions from aviation did not exceed 37.5 MtCO₂ in 2050, in line with the planning assumption recommended by the CCC.

3.51 The objective of using these two approaches was not to identify a single 'correct' forecast, but rather to understand the varying effects on aviation demand of constraining and pricing carbon emissions. In effect the two worlds set out above represent the range of possible ways in which aviation in the UK may contribute to achieving stabilisation of the global climate. The future reality is most likely to lie somewhere between the two. For example, already today we can see a shift towards the international trading of carbon. Both approaches assumed international aviation emissions are assigned to the UK economy on the basis of departing flights. The Commission has continued to use both approaches in the forecasts prepared for consultation and its subsequent analysis.

3.52 The Commission's current forecasts, which have been updated since the *Interim Report*, indicate that demand for aviation in the UK, in the absence of any

³² In preparing these forecasts, the Commission has focused on carbon dioxide emissions from aviation. Aviation also produces other emissions which are included in the Kyoto basket of greenhouse gases, but these are small in comparison to its carbon dioxide emissions (approximately 1 per cent in 2010) and so would not be expected to materially affect the Commission's conclusions. In respect of non-Kyoto climate effects, such as NO_x and induced cirrus, which were discussed in Chapter 4 of the *Interim Report*, the Commission agrees with the CCC's position that these should be further researched, closely monitored and reduced where possible, but not included in carbon budgets.

constraints on capacity, is likely to grow significantly (**Figure 3.6**). In the carbon-traded forecast, shown in the figure below, the central estimate is for demand roughly to double between now and 2050 to around 470 million passengers per annum (mppa).³³

Figure 3.6: UK aviation demand is forecast to grow strongly

Unconstrained national air passenger forecasts, carbon-traded, 2008-2050

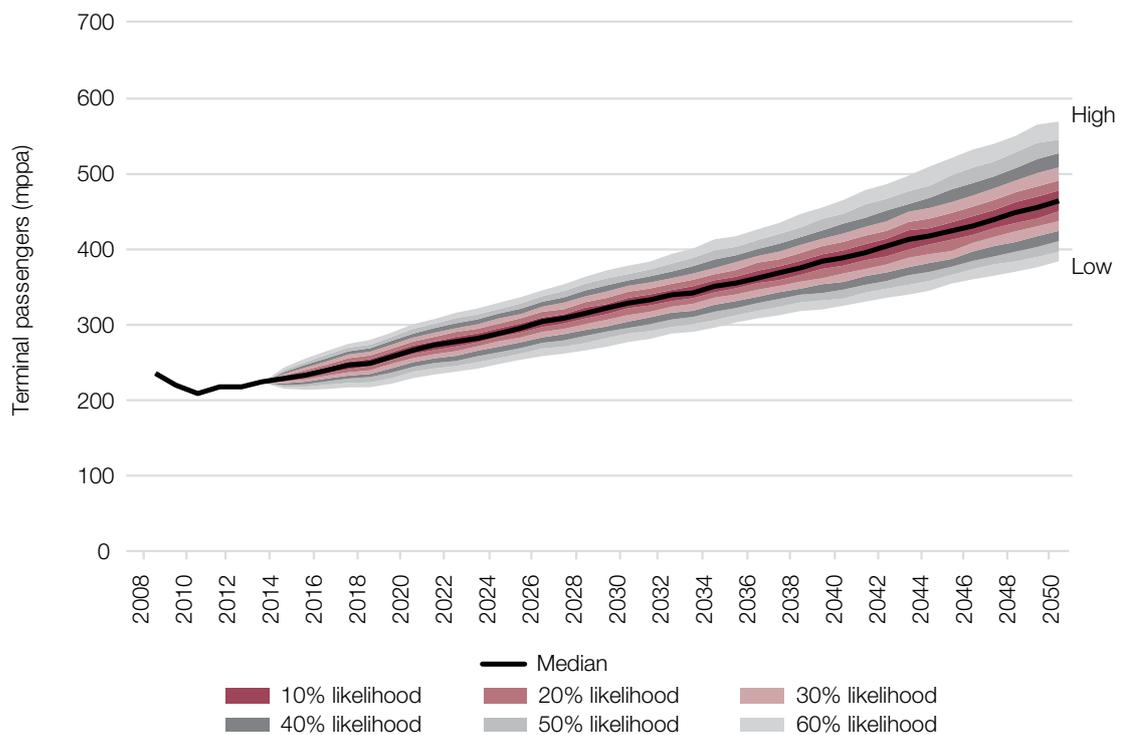

Source: Airports Commission analysis

- 3.53** The same forecast with a carbon cap in place predicts passenger increases to 300 mppa by 2030 and 370 mppa by 2050. This is equivalent to demand growth of approximately 61% between 2005 and 2050, and hence broadly in line with the CCC's own assessment of the level of demand growth consistent with its planning assumption for aviation.
- 3.54** Even with CO₂ emissions from aviation capped in this way, the London airport system as a whole is projected to reach 90% of available runway capacity by 2030, a level at which efficient operations would be increasingly difficult to maintain. During peak times, levels of capacity utilisation would be even higher. As demand continued to increase over the following years, this is likely to create more and more

³³ These forecasts are for the *assessment of need* scenario. Unconstrained passenger demand in 2050 falls in the range 430 – 570 million in the carbon-traded case, and 342 – 407 million in the carbon-capped case across the Airports Commission's scenarios.

significant airspace challenges, take away scope to manage periods of severe weather or incidents and cause higher unreliability and delays for passengers.

- 3.55** The level of unconstrained demand forecast within the London system is greater still, indicating that by 2030 some passenger demand is likely to be choked off by constraints on capacity, even allowing for the impact of a carbon cap and projected increases in aircraft size and loadings. By 2050, without new runway capacity, unconstrained demand with carbon emissions capped is forecast to significantly outstrip the level that could be accommodated by the London airports system, and is higher again in the Commission's carbon-traded forecasts.
- 3.56** Before concluding that additional runway infrastructure was needed to address the capacity constraints in the London airports system, the Commission considered a broad spectrum of alternative measures including changes to taxation, investment in high speed rail or improved surface access options and novel concepts such as remote central terminals to maximise the use of existing runway capacity. The Commission also took into account the development of new technologies that could potentially diminish aviation demand in the future, such as videoconferencing or 3D printing.
- 3.57** None of these options, however, was able to deliver a sufficient increase in capacity and many required investment far in excess of the cost of runway expansion. For example, if all domestic flights were replaced with high speed rail services this would on current schedules only free up some 55,000 air transport movements across all London airports and 35,000 at Heathrow. It would require a level of investment several times higher than that of an additional runway and would entail significant environmental impacts.
- 3.58** While the development of new technologies could offer alternatives to flying, the scope to replace air travel should not be overstated.³⁴ Although evidence suggests that some businesses are keen to cut back on flights and use videoconferencing instead,³⁵ face-to-face contacts are likely to remain important in many business contexts and videoconferencing may actually encourage more international interactions. As 3D printing is becoming more widely used, it may have some

34 CCC (2009), Meeting the UK aviation target, pp. 78-81. See also Mokhtarian (2009), If telecommunication is such a good substitute for travel, why does congestion continue to get worse?

35 WWF, One in Five Challenge (2011/12 Annual Report), http://assets.wwf.org.uk/downloads/one_in_five_report.pdf. For a similarly optimistic view of the potential for teleconferencing to reduce business travel, see Cairns (2010), Can teleconferencing reduce business travel.

impact on global supply chains, but it is unlikely to significantly affect the sectors that are strongly reliant on air freight, such as machinery, pharmaceuticals or food.

3.59 To test the potential for using taxation to smooth demand and ensure a more economically efficient distribution of the currently constrained network, the Commission assessed the impact of increasing APD at capacity constrained airports.³⁶ Rather than driving more effective usage of existing capacity and delivering enhanced connectivity, the effect was a reduction in flights from Gatwick, but not from Heathrow, and the loss of 6 daily destinations from the UK, 5 of which were long haul destinations.

3.60 Changing the rates of APD was not the only redistribution mechanism considered. Changes to the slot allocation regime, to Traffic Distribution Rules and prohibitions on certain types of flights at the most congested airports were also examined, but none was assessed as being a viable or effective option:

- Changes to the slot allocation regime would require agreement at a European or international level and the Commission has seen no evidence that such an agreement is likely to be possible, nor that an alternative method of allocating slots would necessarily deliver an improved outcome.
- Traffic Distribution Rules cannot compel airlines to use specific airports and therefore if routes are not commercially attractive at a different airport, they will be lost.
- Prohibiting certain types of flights, for example domestic or freight only, from Heathrow or Gatwick, would not be effective due to the low numbers of these types of flights currently (especially from Heathrow), the importance of feeder traffic to long-haul route networks and domestic flights to UK connectivity.

3.61 The Commission concluded that, in order to maintain the UK's status as an international hub for aviation, firm action was needed to tackle emerging connectivity problems and maintain a truly competitive UK airport system and that this could not be achieved without new infrastructure being provided. Therefore, there is a clear need for one net additional runway in London and the South East by 2030.

3.62 This conclusion holds across a range of scenarios for the development of the aviation sector that the Commission developed for the *Interim Report*, in order to test the robustness of its recommendations. Even in the most pessimistic scenarios of how the global economy and the aviation sector may develop, all London airports

36 *Interim Report*, pp.121-122

except Stansted were projected to be full by 2040 and the case for expanding runway capacity was robust.³⁷

- 3.63** The new capacity provided by an additional runway would alleviate the constraints on the route network and provide the users of aviation with the connectivity that they need for years to come. An additional runway could deliver significant benefits for the UK without breaching the UK's climate change commitments or requiring aviation emissions to exceed the planning assumption set by the CCC.
- 3.64** The Commission's *Interim Report* also concluded that there is likely to be a demand case for a second additional runway to be in operation by 2050 or, in some scenarios, earlier, although this does not necessarily mean that there would be a strong economic, commercial or environmental case. Any future decision on this issue would need to be closely scrutinised in light of the future development of the aviation sector, the economic situation and the broader policy context including, crucially, climate-change policy.
- 3.65** The Commission also concluded that in planning additional capacity the optimal approach would be to continue to invest in an airport system that can cater for a range of airline business models. That is particularly important in a competitive airports system like London's, where airlines can choose how to use the available capacity, and the market can be expected to respond dynamically to the provision of new infrastructure.
- 3.66** Since the publication of its *Interim Report* the Commission has carried out further engagement with airlines operating in the UK and with potential future entrants into the UK market, which has enabled it to develop this analysis further. This has been a key element of its assessment of the short-listed options and is discussed in more detail in **Chapter 6**.

Reaching a shortlist

- 3.67** In February 2013, the Commission invited interested parties to submit outline proposals for providing new airport capacity in the longer term.³⁸ This was followed in May 2013 by the publication of the criteria against which those proposals would be sifted, on which the Commission had previously consulted.

³⁷ These scenarios were further developed to form a core element of the Commission's assessment of the three short-listed schemes, and are discussed in detail in **Chapter 6**.

³⁸ <https://www.gov.uk/government/publications/submitting-evidence-and-proposals-to-the-airports-commission>

- 3.68** The Commission received more than 50 proposals. Many were for the creation of new runway capacity, whether at existing or new airport sites, though some were for alternatives to runway capacity, such as enhanced surface access links or demand management measures. Some of the proposals covered more than a single possible option and the Commission also developed further potential options itself to ensure a wide range was considered.
- 3.69** A three stage sifting process was used to identify the short-list of three schemes judged to be sufficiently credible to take forward for further development and appraisal in the second phase of the Commission's work:
- Heathrow Airport: Northwest Runway,
 - Heathrow Airport: Extended Northern Runway,
 - Gatwick Airport: Second Runway.
- 3.70** By the time of its *Interim Report*, the Commission did not have sufficient evidence on which to base a decision as to whether the proposal for a new hub airport in the inner Thames Estuary was credible. It therefore carried out further studies and consultation before concluding in September 2014 that this option should not be added to its short-list (see box below).

The inner Thames Estuary option

In its *Interim Report*, the Airports Commission noted that the option of a new airport in the inner Thames Estuary potentially offered attractive benefits as well as significant challenges. This option was therefore judged to warrant further study before a decision could be taken as to whether it should be included on the short-list.

In January 2014, the Commission therefore opened a call for evidence inviting submissions from interested parties and consulted on draft terms of reference for four studies into the feasibility and impacts of an inner Thames Estuary airport. These focused on:

- environmental impacts;
- operational feasibility and attitudes to moving to a new airport;
- socio-economic impacts; and
- surface access.

The completed studies were published for consultation in July 2014. Together with the responses received to the Commission's call for evidence, they provided a significantly enhanced evidence base to inform its decision on this option.

As part of the assessment process, a number of proposals were reviewed, including schemes submitted by the Mayor of London, Foster+Partners, Thames Reach Airport and Metrotidal Tunnel Ltd and the Independent Aviation Advisory Group. The Commission's analysis assumed, in line with the Mayor of London's proposal, amongst others, that Heathrow Airport would need to close for any major new hub airport to the east of London to be commercially successful.

The Commission's analysis indicated that the noise benefits from closing Heathrow and opening a new airport in the inner Thames Estuary would be substantial, and there would be the potential for positive local economic effects (although they would need to be offset against the negative impacts of closing Heathrow). Conversely, the Commission identified a number of significant delivery risks, including in respect of:

- the scheme's significant impacts on protected habitats and the scale of provision of compensatory habitat required;
- the challenges of transferring aviation services and associated activities from Heathrow to a new airport to the east of London;
- uncertainties as to the scope for the airport to co-exist with the nearby Liquid Natural Gas storage facility; and
- the scale and cost of the surface access improvements required.

The Commission also noted a number of other disadvantages, including the substantial costs and public expenditure implications of any such airport, its less convenient location than Heathrow for the majority of passengers and the limited support from the aviation industry and business community and from the local authorities nearby. Surface access costs alone were estimated as lying in the range £20 – £44 billion, excluding the purchase of any land required.

On balance, the Commission concluded that the proposal for a new airport in the inner Thames Estuary had substantial disadvantages that collectively outweighed its potential benefits. Cumulative obstacles to delivery, high costs and uncertainties in relation to its economic and strategic benefits contributed to an assessment that it did not represent a credible option for shortlisting.

3.71 The following chapters set out how the Commission assessed the economic, social and environmental impacts of the three shortlisted options and came to its final decision.

4. The Commission's Appraisal and Consultation Process

Introduction

- 4.1** The first three chapters of this report set out the background and context of the Commission's work.
- 4.2** This chapter explains how the Commission has consulted on the short-listed options. The following chapters provide a description of each of the three short-listed options and its associated surface access improvements and an overview of the Commission's assessments of them against its *Appraisal Framework*.

Developing and appraising the Commission's short-list

- 4.3** Following its *Interim Report*, the Commission invited the promoters of the three short-listed proposals to develop and submit updated scheme designs, incorporating the following elements:
- **Strategic Argument**, outlining why the proposal would be well placed to address the UK's future aviation capacity and connectivity needs and how it may support the socio-economic development of local areas, regions and the UK as a whole;
 - **Airport Master Plan**, providing details of the airfield design and its planned modes of operation, including planned airspace requirements;
 - **Engineering Plans**, comprising information on costings, energy and utilities requirements, environmental issues and surface development plans;
 - **Mitigation Strategies**, comprising plans to limit detrimental and enhance positive impacts on the environment and local communities; and
 - **Development Strategies**, detailing how the additional capacity would be funded and project-managed to delivery.

- 4.4** The updated scheme designs were submitted to the Commission in May 2014 and published on its website as part of the national consultation process.³⁹
- 4.5** To inform its detailed assessment of the short-listed proposals, the Commission also designed and consulted on an *Appraisal Framework* in the first part of 2014. The Framework broke down the eight sift criteria used to select the three schemes into sixteen detailed appraisal modules and identified one or more objectives for each module.
- 4.6** Those objectives covered a broad range of economic, environmental and social impacts, along with operational and commercial viability and deliverability. They were designed to enable an integrated approach to the short-listed options, looking at their effects at local, regional and national level, and considering how the benefits and costs may best be balanced, with any positive effects enhanced and negative impacts mitigated. They also ensured that airport expansion was not considered in isolation, but that its interactions with the wider transport network and with the country's broader policy frameworks were taken into account, along with its effects on individuals, communities and businesses.
- 4.7** Each module of the *Appraisal Framework* set out the technical approaches which would be used to assess each scheme against the relevant objectives. In developing these methodologies, the Commission was guided by a Sustainability Reference Group (an advisory body comprising relevant Government departments, the Environment Agency, Natural England and English Heritage) and by members of its Expert Advisory Panel.
- 4.8** While in many areas the *Appraisal Framework* drew upon established guidance, such as the Department for Transport's WebTAG or HM Treasury's Green Book, in other areas it incorporated new and updated approaches to assess the effects of expanding aviation capacity. These included enhanced methodologies for considering the national and local economic impacts, noise impacts and competition impacts of the short-listed schemes.
- 4.9** Following the completion of consultation, the final *Appraisal Framework* was published in April 2014. The objectives are set out in **Table 4.1**.

³⁹ Since the Commission's analysis began in the summer of 2014 all three scheme promoters have continued to refine their designs. These refinements have not been captured within the Commission's appraisals and are not expected to significantly alter the key appraisal findings. They are nevertheless reflective of the further stages of detailed design that the Commission expects the airport operator to carry out ahead of seeking planning consent.

Table 4.1: The Commission's Appraisal Framework objectives

Sift criteria categories	Appraisal objective
Strategic Fit	To provide additional capacity that facilitates connectivity in line with the assessment of need.
	To improve the experience of passengers and other users of aviation.
	To maximise the benefits of competition to aviation users and the broader economy.
	To maximise benefits in line with relevant long-term strategies for economic and spatial development.
Economy	To maximise economic benefits and support the competitiveness of the UK economy.
	To promote employment and economic growth in the local area and surrounding region.
	To produce positive outcomes for local communities and the local economy from any surface access that may be required to support the proposal.
Surface Access	To maximise the number of passengers and workforce accessing the airport via sustainable modes of transport.
	To accommodate the needs of other users of transport networks, such as commuters, intercity travellers and freight.
	To enable access to the airport from a wide catchment area.
Environment	To minimise and where possible reduce noise impacts.
	To improve air quality consistent with EU standards and local planning policy requirements.
	To protect and maintain natural habitats and biodiversity.
	To minimise carbon emissions in airport construction and operation.
	To protect the quality of surface and ground waters, use water resources efficiently and minimise flood risk.
	To minimise impacts on existing landscape character and heritage assets.
	To identify and mitigate any other significant environmental impacts.
People	To maintain and where possible improve the quality of life for local residents and the wider population.
	To manage and reduce the effects of housing loss on local communities.
	To reduce or avoid disproportionate impacts on any social group.

Sift criteria categories	Appraisal objective
Cost	To make efficient use of public funds, where they are required, and ensure that the benefits of schemes clearly outweigh the costs, taking account of social, environmental and economic costs and benefits.
Delivery	To be affordable and financeable, including any public expenditure that may be required and taking account of the needs of airport users.
	To have the equivalent overall capacity of one new runway operational by 2030.
	To actively engage local groups in scheme progression, design and management.
Operational Viability	To enhance individual airport and airports system resilience.

4.10 Before the consultation on the three short-listed options, two discussion papers were also published covering:

- *The utilisation of the UK's existing airport capacity* (published June 2014). The paper focused on the UK's regional airports, and the measures that could be taken to support them, and the role and development of airports in the wider South East.
- *The delivery of new runway capacity* (published July 2014). It considered legal and planning issues, options for addressing impacts on local communities, and the role of the state, for example in respect of funding or regulation.

4.11 The analysis in these discussion papers and the responses to them have informed the recommendations in this *Final Report*. They have been particularly valuable in respect of the measures to address local concerns and to enhance regional connectivity set out in **Chapters 14** and **15**.

4.12 In November 2014, the Commission published its assessments of the three short-listed schemes for consultation. The core purpose of the consultation process was to test the evidence base, to identify any concerns stakeholders may have as to the accuracy, relevance or breadth of the assessments undertaken, and to seek views on the potential conclusions that might be drawn. The consultation questions are shown in **Table 4.2**.

Table 4.2: The consultation questions published in November 2014

Question inviting views and conclusions in respect of the three short-listed options	Q1: What conclusions, if any, do you draw in respect of the three short-listed options? In answering this question please take into account the Commission's <i>Consultation Documents</i> and any other information you consider relevant.
	Q2: Do you have any suggestions for how the short-listed options could be improved, i.e. their benefits enhanced or negative impacts mitigated?
Questions on the Commission's appraisal and overall approach	Q3: Do you have any comments on how the Commission has carried out its appraisal?
	Q4: In your view, are there any relevant factors that have not been fully addressed by the Commission to date?
Questions inviting comments on specific areas of the Commission's appraisal	Q5: Do you have any comments on how the Commission has carried out its appraisal of specific topics (as defined by the Commission's 16 appraisal modules), including methodology and results?
	Q6: Do you have any comments on the Commission's sustainability assessments, including methodology and results?
	Q7: Do you have any comments on the Commission's business cases, including methodology and results?
Other comments	Q8: Do you have any other comments?

4.13 To allow a broad spectrum of stakeholders and interested parties to contribute informed responses to this consultation, a range of documents were published, ensuring that different levels of detail were available for different audiences. The *Consultation Document* itself provided an overview of the three options and the Commission's appraisal outputs, a fuller assessment of the evidence for each scheme was set out in a supporting *Business Case and Sustainability Assessment*, and below that were a series of technical studies undertaken on specific aspects of each scheme (for example, a scheme's potential noise impacts, or an assessment of a scheme's local economic impacts), which provided the detailed evidence to support the *Business Case and Sustainability Assessment*.

- 4.14** The outputs in each report were a representation of how each scheme might affect a range of people, from those living in nearby communities, to people employed at each airport, to those using them to travel for business or for leisure. Given these broad impacts, the Commission's consideration of each of the options has been informed not only by its technical analysis, but also by the engagement it has had with a wide range of stakeholders including visits to the short-listed sites and their local communities.
- 4.15** The Commission also held a full-day public discussion session in each of the local areas around Heathrow and Gatwick, to hear first-hand the views and concerns of local stakeholders, including MPs and Councillors, community groups and business organisations. An event was also held in Manchester, to enable stakeholders from outside London and the South East to learn about the consultation and how to respond to it.
- 4.16** Over 70,000 responses were received to the consultation from stakeholders on all sides of the debate, including airlines and airports, large and small businesses and their representative bodies, local authorities and elected representatives at every level, environmental organisations, and many local community groups. By far the largest group of responses was received from private individuals, many living close to the airports under consideration, putting forward their views on the Commission's work and on the merits of the options for expansion.
- 4.17** The Commission's analysis of these responses has been published as a companion report. It has been used to develop substantially the evidence base to allow a final and comprehensive appraisal of the short-listed schemes against the best available data and knowledge. That has included the preparation of a large number of additional or updated reports on issues including noise, surface access, health and equalities, economic benefits, quality of life and operational and commercial viability. Each is discussed in the following chapters, and in the updated *Business Case and Sustainability Assessment* published alongside this *Final Report*.
- 4.18** In addition, the Commission has carried out a further consultation on the outputs of a more detailed air quality analysis that had not been available prior to the commencement of its broader consultation on the short-listed options. Over 1,850 responses were received to that consultation, and they have informed the assessments and conclusions in this *Final Report*. A document summarising the Commission's consideration of those responses has been published as a separate report.

4.19 Throughout the Commission's work, its approach has been informed by the principles of the Strategic Environmental Assessment (SEA) Directive. In particular, the Commission's methodology has taken account of the social and environmental costs of the options considered alongside their anticipated benefits, and it has considered a range of alternative strategies for meeting the stated policy objectives, starting with the initial long-list of proposals assessed in the process of preparing the *Interim Report*, which included non-aviation and non-infrastructure options, and continuing into the more detailed analysis of the three short-listed proposals on which the recommendations in this report are based. This will help to ensure that the Commission's analysis can provide a firm foundation for any future National Policy Statement or Hybrid Bill, should the Government decide to adopt its recommendations.

5. The Short-listed Schemes

Introduction

5.1 This chapter describes the designs for each of the three short-listed schemes, as submitted by the promoters. It should be noted that any of the plans described below would need to be subject to more detailed design and environmental assessment, and further public consultation, to prepare for planning consent through either the National Policy Statement or Hybrid Bill route.

Gatwick Airport Second Runway

5.2 The scheme proposed by Gatwick Airport Ltd is for a new full length runway to the south of and running parallel to the existing runway, as illustrated in the airport's masterplan below.

Figure 5.1: Gatwick Airport Second Runway masterplan

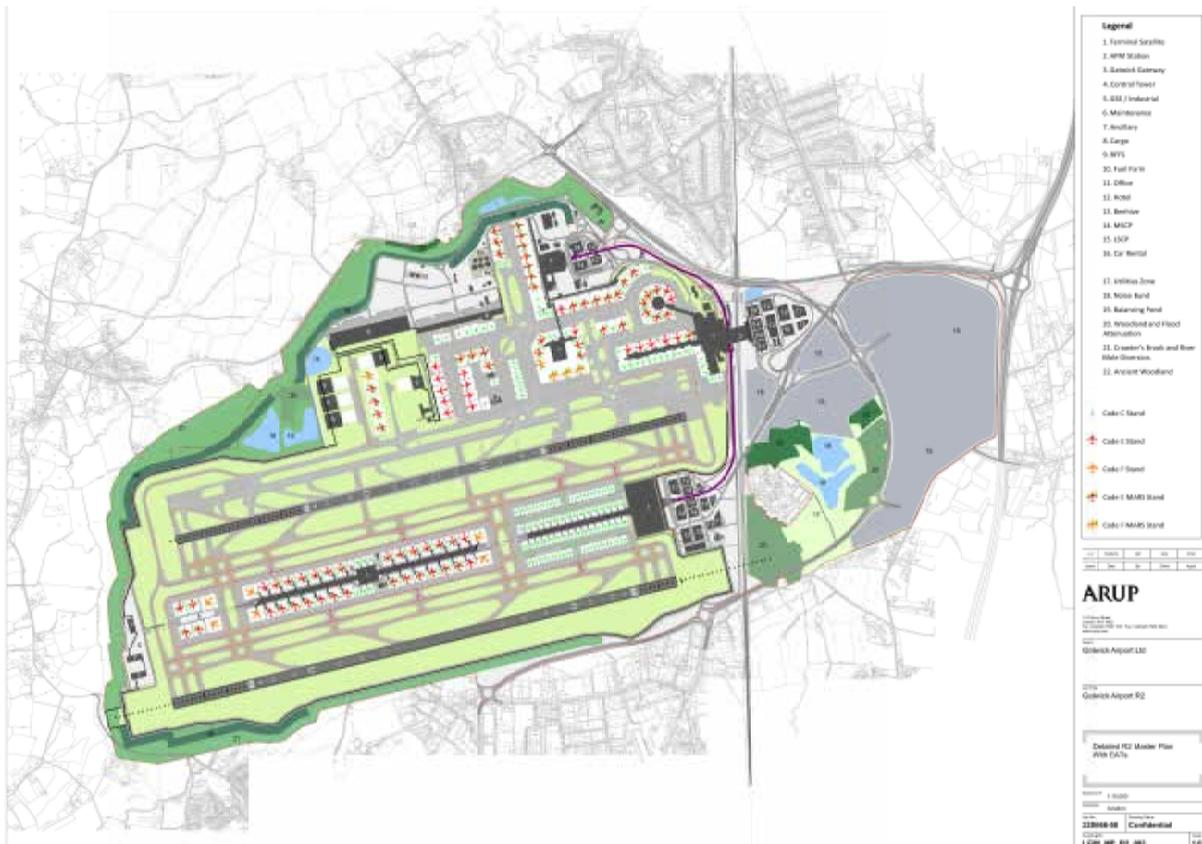

- 5.3** The space between the runways would be set at 1,045m, which would provide room for the required supporting airport infrastructure – a new terminal building, main pier and satellite. It would also be needed to permit simultaneous independent mixed mode operations on each runway, as proposed by the scheme promoter, which would enable the proposed operating capacity of 560,000 air transport movements per annum.
- 5.4** The capacity of the new terminal building would be approximately 50 million passengers per annum (mppa), slightly higher than the combined capacity of the two existing terminal buildings (which is around 45 mppa).
- 5.5** The scheme would, however, be built in phases, with the runway constructed first and different stages of terminal capacity being opened as passenger numbers increase. The design submitted for consultation proposed that initially only a remote pier would be constructed alongside the new runway, with all of the airport's passengers continuing to use the current terminal facilities. The Commission highlighted that this presented risks to passenger experience at the expanded airport and in its consultation response the scheme promoter altered its approach to phasing so that an initial phase of terminal development would be provided in parallel with the second runway opening.
- 5.6** The airport's footprint would extend to the south to encompass the space for the new runway; and to the east, broadly to the M23, to provide space for ancillary airport services and parking. In total, 624ha is estimated to be required for airport development, subject to more detailed design work, and up to an additional 78ha for surface access improvements. These land take requirements could change following detailed construction and surface access route design, and any potential mitigations. No additional land take for flood storage scheme is identified in the proposal.
- 5.7** The surface access design for Gatwick is based on a combination of existing infrastructure, schemes which already have firm funding commitments and schemes which are likely to be required by 2030 in order to meet background demand growth.
- 5.8** The ongoing Thameslink programme will provide the bulk of the enhancements necessary, increasing the airport's service frequency to Central London from 15 trains to 26 trains per peak hour. In addition, further improvements, currently unfunded, will be required to the Brighton Mainline in order to meet demand pressures, with or without airport expansion. A full description of the surface access

proposition for the Gatwick Second Runway scheme, including relatively minor additional works on the road network, is provided in **Chapter 8**.

Heathrow Airport Northwest Runway

5.9 The scheme proposed by Heathrow Airport Ltd is for a new full length runway (3,500m) to the north west of the current northern runway at Heathrow, as set out in the airport's masterplan below. It is important to note that this proposal differs very significantly from that supported by the government before 2010. It provides a full-length runway, maximizing the potential to improve capacity, connectivity and resilience, and it is sited further to the west, which has the key benefit of reducing its noise and wider community impacts.

Figure 5.2: Heathrow Airport Northwest Runway masterplan

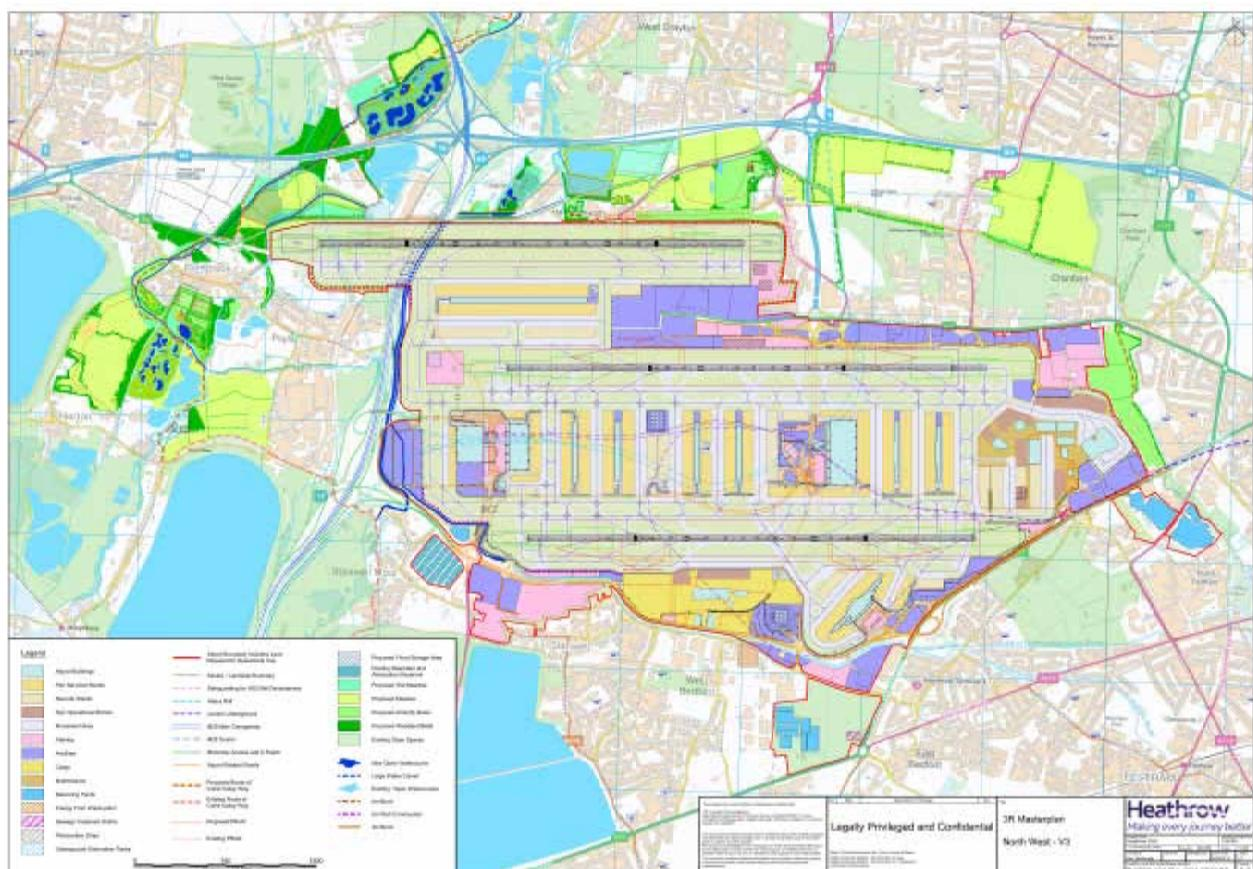

5.10 The horizontal separation between the new runway and the current northern runway is 1,045m, allowing it to operate independently of the existing runways. When the promoter's proposed alternation pattern is factored in this would allow a forecast operating capacity of 740,000 air transport movements per year and would offer a level of continuing respite for local communities while enhancing the airport's resilience.

- 5.11** A new terminal building would be built to the west of the current central terminal area, with the majority of the airport's terminal space and satellites and the transport spine of the airport continuing to run between the two existing runways in what is often referred to as a 'toast rack' configuration. This new terminal would be built with similar dimensions to Terminal 5, and will be constructed in stages. When complete it will have a capacity of 35mppa, similar to that of Terminal 5 (currently 30 mppa).
- 5.12** The airport footprint would expand north-westwards to accommodate the new runway and also to the south, west and east to make space for ancillary services and commercial development.
- 5.13** In total, 569ha of land would be directly required for the airport development, with up to an additional 43ha for flood storage and 294ha for related surface access improvements. Approximately 431ha of this is within designated Green Belt. These land take requirements however, could change following detailed construction and surface access route design, and any potential mitigations.
- 5.14** The surface access strategy for the Northwest Runway scheme is based on a combination of existing infrastructure, schemes which already have firm funding commitments, schemes which are likely to be required by 2030 in order to meet background demand and those which are required to support expansion, either through accommodating the expanded airport site or providing new links and capacity to improve public transport mode share. Crossrail, Western Rail Access and Southern Rail Access will transform the airport's public transport offering. A full description of the surface access proposition for the Northwest Runway scheme is provided in **Chapter 8**.

Heathrow Airport Extended Northern Runway

- 5.15** The proposal put forward by Heathrow Hub Ltd for the Heathrow Airport Extended Northern Runway scheme is for an extension of the existing northern runway to the west. This would effectively create two separate runways, each 3,000m in length, with a 650m safety area in between, enabling them to be operated independently.

- 5.18** The airport's footprint would expand to the west, north and south, with a total direct land take of 336ha. Additional land take for surface access improvements and flood storage of up to 330ha and 57ha respectively may also be required. Approximately 278ha of the proposed land take would lie within Green Belt. As for the other schemes, these land take requirements could change following detailed construction and surface access route design, and any potential mitigations.
- 5.19** In relation to surface transport, the Commission has carried out its assessment of the Extended Northern Runway scheme on the basis of the same 'on-site' surface access strategy as for the Northwest Runway proposal. This has ensured that the two runway schemes are considered on a consistent basis. For the rail network, this means that an identical package of measures is required, but the road interventions vary slightly between the two schemes as the design of the Extended Northern Runway requires a number of different works on the local road network. This is considered in more detail in **Chapter 8**.
- 5.20** Although the Commission's core analysis has focused on an 'on-site' surface access package, it has also assessed the proposal put forward by Heathrow Hub Ltd for a surface access strategy centred on a new hub station on the Great Western Mainline, approximately 2-3 miles to the north of the current airport boundary. As set out in the *Interim Report*, this has been considered as a detachable concept that could be put alongside either of the Heathrow runway options. The hub station would be connected to the airfield site via an automated people mover. The Commission found that, on balance, the higher costs of this scheme compared to Western Rail Access to Heathrow and its negative impact on journey times for passengers not travelling to the airport outweighed its potential benefits. A full discussion of this proposal is contained in **Chapter 8**.

Assessing the short-listed schemes

5.21 This next section of the report sets out the Commission's assessments, of the schemes, on the basis of its appraisal framework, as follows:

- **Chapter 6: Strategic Fit**
- **Chapter 7: Economic Impacts**
- **Chapter 8: Surface Access**
- **Chapter 9: Environmental**
- **Chapter 10: People**
- **Chapter 11: Commercial Viability and Delivery**
- **Chapter 12: Operational Viability**

6. Strategic Fit Assessment

Introduction

- 6.1** The assessment of strategic fit analyses how each of the short-listed options performs against the following appraisal objectives:
- **to provide additional capacity that facilitates connectivity in line with the assessment of need;**
 - **to improve the experience of passengers and other users of aviation;**
 - **to maximise the benefits of competition to aviation users and the broader economy;** and
 - **to maximise benefits in line with relevant long-term strategies for economic and spatial development.**
- 6.2** The Commission's terms of reference required it to carry out "a review of the evidence in relation to the current position in the UK with regard to aviation demand and connectivity, forecasts for how these are likely to develop, and the expected future pattern of the UK's requirements for international and domestic connectivity." The findings of that review formed the assessment of need set out in the *Interim Report*.
- 6.3** The conclusion of the *Interim Report* was that capacity equivalent to one net additional runway would be needed in south east England by 2030, and that the optimal solution would be to continue to invest in an airport system which can cater for a range of airline business models, enabling it to adapt to the future needs of residents and businesses in the UK and not be predicated on any single view of the future of this industry.
- 6.4** The additional capacity provided would ensure that UK travellers and businesses continued to benefit from strong international connectivity; in particular through routes to emerging markets, which are likely to be increasingly important for the country's economic prosperity. This connectivity should also be produced in an airport system that supports a competitive market and effectively meets the needs of passengers and other users of aviation.

- 6.5** The Strategic Fit appraisal module assesses how effectively the short-listed options deliver against those goals. It also considers the benefits of each option for the air freight sector, which plays an important role in the UK economy and can also be the deciding factor that makes a new long-haul route viable. It is important that any new capacity caters effectively for growth in this market.
- 6.6** The impacts of expansion would not only be felt, however, by the aviation industry and its customers. Decisions on where to build new airport capacity are among the most important strategic choices a country can make, with extensive consequences for the economic, environmental and social development of cities and regions. So the module considers how each of the short-listed options can support wider spatial and socio-economic development strategies.
- 6.7** Finally, new aviation capacity and the enhanced international connectivity that it facilitates can have a significant impact on the overall economy, enhancing trade and productivity and supporting growth across a broad range of sectors from tourism to manufacturing. The Commission has previously presented its analysis of these impacts as part of the Economic Case but, in the light of consultation responses and advice from its Expert Advisory Panel, has reached the view that it more appropriately forms part of its strategic analysis, providing a quantified assessment to accompany the broader analysis described above.

Methodology

Scenario-based forecasting

- 6.8** In February 2013, the Airports Commission published, *Discussion Paper 1: Aviation Demand Forecasting*. On the basis of responses to the paper, the Commission concluded that the Department for Transport's aviation model offered the most robust forecasting tool available to assess national demand for aviation in the UK, and its potential allocation between airports. The Commission has retained the model as the basis for its forecasts but made a number of improvements, including in particular the incorporation of competition from international hubs into the model.
- 6.9** It has also continued to produce forecasts on a carbon-traded and carbon-capped basis, as discussed in **Chapter 3**. Its recommendations take into account the potential implications of different domestic and international carbon policy outcomes, including in particular the effects of CO₂ emissions from UK aviation being constrained to the Committee on Climate Change's (CCC) planning assumption of 37.5MtCO₂ in 2050.

- 6.10** In addition, as a key element of its risk-based process, the Commission's approach to forecasting recognises the complexity of predicting how many of the other factors influencing the aviation industry's development may change over the coming decades. These include the rates of economic growth which may be achieved in different regions of the world, operating costs such as fuel prices, levels of protectionism or liberalisation within the industry and the potential impact of new operating models within the aviation industry (for example, the expansion of low-cost carriers into new markets).
- 6.11** To take account of those uncertainties, the Commission developed a range of scenarios for how the aviation sector and the broader global economy might develop, which have been incorporated in its forecasts of future demand. They were initially devised to test the analysis of the need for new capacity presented in the *Interim Report*. Since then they have been further developed for use in assessing the three short-listed options. The five scenarios are described in the table below and discussed in more detail in the technical report, *Strategic Fit: Updated Forecasts*.

Airports Commission forecast scenarios

The five scenarios represent different views of how the aviation sector and other macro economic factors may develop.

<i>Assessment of need</i>	Future demand is primarily determined by central projections published by sources such as the Office for Budget Responsibility, OECD and IMF.
<i>Global growth</i>	Higher global growth in demand for air travel in the future, coupled with lower airline operating costs.
<i>Relative decline of Europe</i>	Higher relative growth of passenger demand in emerging economies in future and a strengthened position of Far and Middle Eastern aviation hubs and airlines.
<i>Low-cost is king</i>	Low-cost carriers strengthen their position in the short-haul market and capture a substantial share of the long-haul market, plus higher passenger demand from all world regions and lower operating costs.
<i>Global fragmentation</i>	Economies adopt protectionist policies, with a decline in passenger demand from all world regions, coupled with higher operating costs.

- 6.12** None of these scenarios was considered a central case. Rather they were used to test the robustness of the Commission's analysis in relation to a range of potential futures. They included not only futures based on central projections of economic growth (which is a key driver of aviation demand) or on the continuation of existing aviation industry models, but also more extreme scenarios in which UK and global economic growth rates are materially raised or lowered, or substantial changes are seen in the industry's structure and operations.
- 6.13** The approach provided a rich data set and ensured the Commission's analysis incorporated a range of possible outcomes which did not rely on any one set of assumptions e.g. around oil prices or the relative performance of European and other global economies. A number of responses raised concerns about the complexity of the approach and the very broad ranges of results produced, arguing that this made it difficult to draw conclusions from the analysis. In addition, some responses also made points regarding the plausibility of one or more of the Commission's scenarios, most often focusing on the connectivity outcomes delivered under the *low cost is king* scenario. In this scenario significant developments in the low-cost sector are combined with high-end estimates of economic growth, resulting in significant additional long-haul connectivity being provided by the low-cost airlines, from both an increase in the frequency of flights and the overall number of destinations served.
- 6.14** In the light of these responses, and of independent advice commissioned from the International Transport Forum at the OECD on the plausibility of the Commission's scenarios (see report: *Review of the UK Airports Commission's Strategic Fit Forecasts and Scenarios*), the approach has been further developed in two ways.
- 6.15** First, the Commission has used a single scenario as the starting point for its analysis of impacts, and then tested those results against other scenarios as appropriate. That simplifies the presentation of the recommendations and results in this report, and enables the relative performance of the three short-listed options to be more easily assessed.
- 6.16** Second, the Commission has selected the *assessment of need* scenario as its starting point. That is in line with the ITF's advice, which states that this 'should be regarded as the most likely forecast',⁴⁰ and reflects its position in the mid-range of the Commission's results, its incorporation of verifiable historic relationships in the growth and allocation of demand and, in particular, its use of central projections of economic and population growth, oil prices and other drivers.

40 *Strategic Fit: Review of Airports Commission's Forecasts and Scenarios.*

6.17 The alternative forecasts generated by the other scenarios have then been used to assess whether different outcomes would change the nature of any conclusions drawn. These could relate either to macroeconomic factors such as economic growth, as in the *global growth* and *global fragmentation* scenarios, or changes in industry structure and operations, as in the *low cost is king* and *relative decline of Europe* scenarios, which the ITF notes are ‘less likely but sufficiently plausible to be worth including as a sensitivity test’. In relation to *low cost is king*, the Commission has also carried out additional analysis to separate the impact of changes in the low-cost sector from those of broader economic trends.

Criticisms of the Airports Commission demand forecasting

Many respondents to consultation offered comments on the Commission’s approach to aviation demand forecasting. A particular criticism, made most strongly by Gatwick Airport Ltd (GAL), was that the modelled allocation of demand between airports was flawed and led to implausible results.

At the core of GAL’s criticism was a concern that the model did not fully recognise its record of strong growth during the last decade and therefore under-forecast at Gatwick and over-forecast at Heathrow. This was based on comparing the forecasts of demand within the London system both with and without capacity constraints to the recent performance of the main London airports.

In relation to the unconstrained forecasts, it is unsurprising that these see higher demand growth than is currently the case at Heathrow, as the long-standing lack of spare capacity at that airport is likely to be one of the most significant factors governing passengers’ choices in the South East. This would have a stronger downward impact on demand at Gatwick than at the other London airports, as Gatwick has a greater overlap with Heathrow in terms of its catchment area and the markets that it serves.

With regard to the constrained forecasts, GAL’s response argues that the long-term growth rates seen in the Commission’s forecasts are at odds with recent trends, with the growth rate in passenger demand at Gatwick having been roughly double that at Heathrow in the decade to 2014. These historic growth rates, however, reflect a period when Heathrow has been heavily constrained whereas Gatwick, although approaching capacity, has still had some space to accommodate new services on its runway. It is unlikely that the recent high rates of growth at Gatwick could be maintained over the long-term once the remaining capacity is used up.

With new capacity added at Gatwick, however, a different pattern is seen in the Commission's forecasts. Once a second runway is in place, Gatwick is predicted to capture 40-50% of passenger demand growth in the London market between 2024 (the year before the proposed second runway could open at the airport) and 2030 and around 60% between 2030 and 2050.⁴¹

Other issues related to the Commission's forecasts made in consultation included the treatment of fares in the model, the relationship between service provision and demand (in particular whether new services could 'shape' demand) and the use of adjustments such as 'seeding' to test alternative airline business models. These, together with the criticisms raised by GAL, are covered in the OECD report: *Review of Airports Commission Forecasts and Scenarios*.

Overall, the Commission believes that its approach to forecasting has been robust and fit for purpose. Furthermore, its scenario-based analysis has helped to ensure that its recommendations are robust to a range of potential futures.

Assessing outcomes for passengers and air freight users

- 6.18** The Commission looked at the impacts of expansion on passenger journeys to and from the airport and the facilities offered inside the terminal buildings, based on a review of the scheme designs submitted by the scheme promoters and assessments conducted for the Surface Access and Operational Efficiency appraisal modules. The analysis has been refreshed in the light of consultation responses, and an assessment of the value of the benefits accruing to passengers as a result of expansion is also made, drawing on the Commission's economic analysis.
- 6.19** An important theme arising from consultation was that the Commission should give greater prominence in its analysis to freight, given the value of air freight to the UK economy, and particularly to trade with emerging markets and other non-EU countries, and to many airlines, notably those operating long-haul routes. This feedback has been taken into account in the assessments and recommendations in this section.

41 The analysis is based on the *assessment of need* carbon-traded forecast, as this is derived most directly from previous patterns of demand.

Analysing competition in the aviation sector

- 6.20** As discussed in **Chapter 2**, over recent decades competition within the UK aviation sector has increased significantly. Growing competition between airlines has been driven by new market entrants, in particular the low-cost carriers in the short-haul market, middle eastern network carriers and airlines from the rapidly growing emerging economies. These new entrants have captured significant market shares due to their lower cost base (particularly labour costs) and through finding innovative ways to operate their aircraft more efficiently.
- 6.21** Airports in the UK are exposed to much more competition than elsewhere due to their unusually high degree of private sector ownership. This is particularly the case in the London airport system, where since the breakup of BAA Ltd in 2009 six airports in different and largely private ownership⁴² compete for passengers in London's origin and destination market, the biggest in the world.
- 6.22** To assess how each of the short-listed options might affect competition and the benefits that this might provide for passengers and other users, the Commission has worked with the ITF at the OECD and SEO Economic Research (an aviation consultancy based in the Netherlands) to assess the likelihood and impact of a number of potential airline responses to each of the three short-listed options under different assumptions for how the global aviation sector may develop.
- 6.23** During consultation, a range of responses were received on competition issues, and three further reports were commissioned to consider points raised. The first looks at the scope for measures to be taken, for example in relation to the slot allocation regime, to enhance the connectivity outcomes from expansion. The second looked at a number of challenges to the ITF/SEO analysis, particularly in respect of the level of scarcity rents in the aviation sector and hence the impact of changes in aeronautical charges. The third report comprised further estimates of the benefits of competition resulting from expansion as suggested by some of the responses to the Commission's consultation. They are available on the Airports Commission website and their findings have been taken into account.⁴³

42 The only exceptions are Gatwick Airport and London City which are both majority owned by the Global Infrastructure Partners, but which nevertheless serve very different passenger bases and hence do not directly compete, and Luton Airport which is publicly owned but run as concession.

43 In order of mention, the three reports are *Strategic Fit: On the Mechanisms that can Potentially Influence Connectivity Outcomes in the UK*, *Strategic Fit: Scarcity Rents and Airport Charges* and *Strategic Fit: Airline Responses to Airport Capacity Expansion – Additional Estimates of Competition Benefits*.

Alignment with economic and spatial development strategies

- 6.24** The assessment of each option's potential contribution to wider economic and spatial development strategies drew upon a review of existing plans – including Local Plans, Strategic Economic Plans set out by Local Enterprise Partnerships, regional development plans, most particularly the London Plan and wider national strategic frameworks such as the National Planning Framework and Aviation Policy Framework.
- 6.25** On this basis, an assessment was made of the value that is placed on each airport as part of any broader socio-economic strategy and the contribution that expansion might make to achieve those strategies, taking into account a broad range of economic, social and environmental assessments.
- 6.26** Responses to consultation raised a number of issues related to these assessments, highlighting in particular the need to consider the potential of each option to support growth outside London and the South East and thereby contribute to the rebalancing of the economy, and arguing that the assessments had underplayed the extent to which expansion at Heathrow was opposed in the Mayor's London Plan. The Commission has taken these points into account.
- 6.27** Some respondents also suggested that the analysis had underestimated the challenges associated with delivering any housing and associated infrastructure needed to support expansion, whether at Heathrow or Gatwick. These comments are considered in the Local Economy section in **Chapter 7** of this report, which explains how any additional demand for new housing might be accommodated through increasing density and expansion in workforce catchment areas.

Valuing the strategic and GDP benefits of airport expansion

- 6.28** Expanding airport capacity may be expected to have a significant effect on the UK's economy. New passenger flows into and out of the country will impact on a number of sectors; new routes and services will enable trade to increase with a wider range of countries and regions across the world, driving gains from imports and exports; more frequent and convenient air services will help to improve productivity; and an expanded airport will generate new employment opportunities.
- 6.29** The Commission has sought to assess these effects, and to identify the scale of impact on GDP, through the use of a Spatial Computable General Equilibrium (S-CGE) model. A model of this kind provides a stylised representation of the national economy and can be used to analyse how impacts in one sector or region affect other areas, showing the scale of potential second- and third-order effects

and providing an indication of the impact across the economy as a whole. Most transport analyses hold the majority of economic factors constant in order to focus in detail on first-order effects, and do not provide a broader national assessment.

Figure 6.1: S-CGE Modelling framework⁴⁴

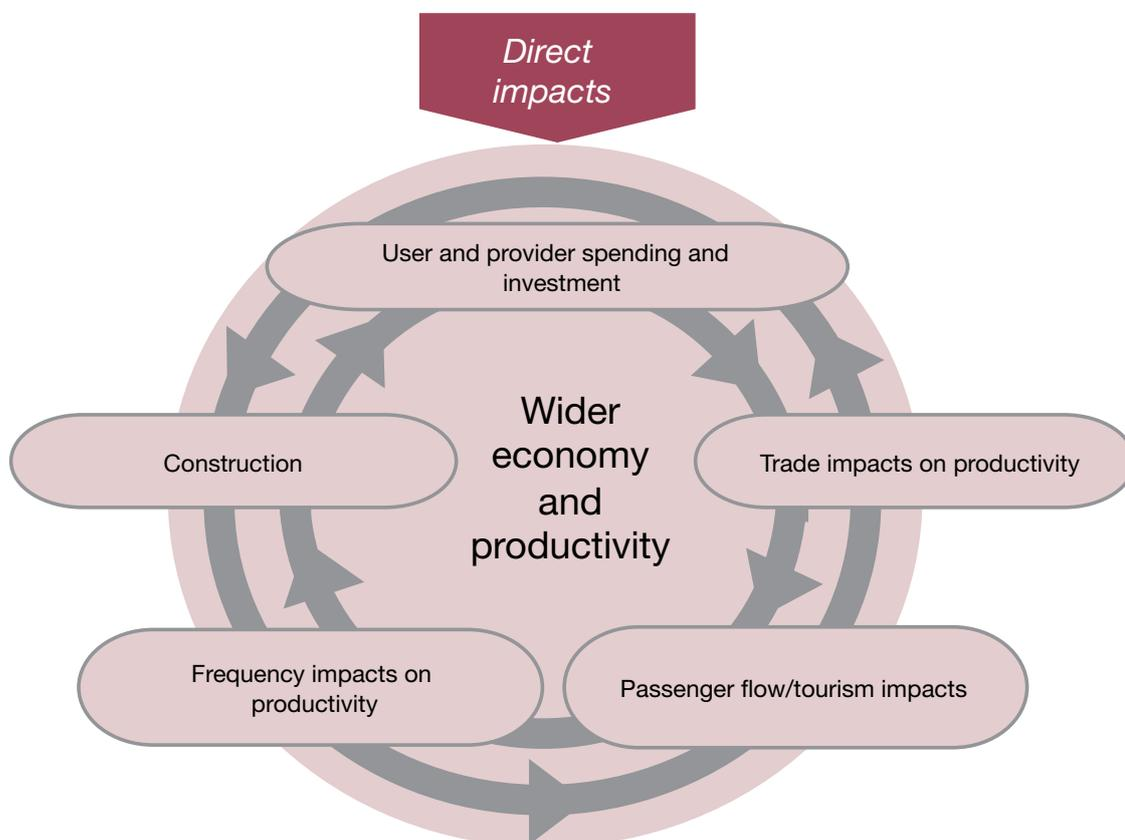

- 6.30** The approach taken here, described in **Figure 6.1**, is particularly valuable in looking at projects such as airport expansion whose scale is sufficient to drive changes at the national level and which are mainly outside the public sector, so that any Government policy decision would be more like a planning determination than a choice about the allocation of public funds.
- 6.31** The use of an S-CGE model in this context is highly innovative and the Commission is only aware of one recent example (in Sydney) where it has been applied to an airport infrastructure investment decision. Some consultation respondents have argued that the results should not be taken into account in the Commission's recommendations, as well as raising a number of specific concerns about the details of the analysis. In the light of these responses, the analysis has been

⁴⁴ The diagram depicts the list of variables modelled in the S-CGE framework. The results presented in the report, however, exclude the economic impacts of construction, as it is reasonable to assume that if construction had not taken place, other construction projects with a similar economic impact would take place elsewhere in the economy.

updated and reviewed, with a number of new sensitivity tests carried out, and specific advice has been commissioned from two members of the Commission's Expert Advisory Panel on the value and appropriate use of this analysis.

- 6.32** The two panellists confirm that it is legitimate to take an alternative approach to assess the economic impacts of transport interventions of significant national scale, since conventional economic analysis would be unlikely to include a number of relevant factors. They agreed, however, that caution should be taken when interpreting the GDP numbers due to the innovative application of the model. They also recommended that the assessment would more appropriately form part of the Strategic than the Economic Case for each option.

Assessment

Enhancing capacity and connectivity

- 6.33** The Commission used its forecasts of future demand without any significant expansion as the baseline against which to test the performance of each scheme were it to be taken forward. It is clear that without expansion the current excess demand for airports in the South East is exacerbated. This excess demand is greatest at Heathrow which has been operating at full capacity for some time. Gatwick is currently operating at capacity during peak hours and will be completely full by the 2020s.
- 6.34** The additional capacity provided by all three short-listed options would alleviate the constraints seen today and enable growing demand for aviation to be accommodated. In each case, the proposed expansion would meet the Commission's assessment of need, which stated that capacity for an additional 170,000-200,000 air transport movements per annum will be required by 2030. Exactly how this extra capacity would affect outcomes for passengers depends on a number of factors, including the approach to managing carbon dioxide emissions from aviation and other macro-economic drivers such as economic and population growth, but in general terms it would be expected to support enhanced connectivity in all cases, with more destinations and a greater frequency of services at the expanded airport.
- 6.35** The nature of this additional connectivity, however, would vary significantly between the schemes to the extent that Heathrow and Gatwick continue to serve different passenger markets.

- 6.36** Heathrow operates as a major hub airport, hosting over 70% of the UK's long-haul flights, with the airlines based there being able to supplement strong local origin and destination demand with transfer traffic (over a third of the airport's passengers at present) to maintain a dense network of routes and services.
- 6.37** Without additional capacity, Heathrow's ability to function effectively as a hub airport is likely to diminish. Increasing passenger demand for direct services will gradually squeeze out transfer passengers from Heathrow, as airlines at the airport increasingly focus on the most profitable links, particularly in the long-haul market, and lower-yielding short-haul services which can be operated from other airports are relocated. The outcome is likely to be a slow erosion of the airport's route network. While the loss of short-haul connectivity may be offset by growth elsewhere, the same will not be the case, for at least a decade or more, for many long-haul routes, as they depend on a greater weight of demand than would be available at any other UK airport.
- 6.38** Adding capacity at Heathrow would reverse this trend, enabling the airport to retain and grow its European and domestic networks and, with this in place, to provide a continuing feed of transfer passengers to add to rising local demand. This, in turn, would help to increase the number of long-haul destinations to which it provides a regular connection. This could be both through existing carriers at the airport extending their networks or through new airlines entering the airport as substantial numbers of new slots become available for the first time in many years. Over time, however, as the airport once more approached capacity, the increase in destinations would slow and eventually the route network may again begin to decline, albeit from a much higher base. That point would be reached earlier with the Extended Northern Runway scheme, as it delivers a smaller increase in capacity.
- 6.39** Gatwick is more heavily focused on the short-haul market than Heathrow, mostly served by low-cost carriers, although it maintains a number of long-haul connections, including on leisure-dominated routes, such as to the Caribbean, and from carriers linking to London from hubs in the Middle and Far East. Most recently, a small number of long-haul services to the US have also been established from the airport by low-cost carriers, and routes to Canada are projected.
- 6.40** Expansion at Gatwick would, in the Commission's view, be most likely initially to build upon these strengths. It would release a significant number of new slots into the constrained London system, which would be attractive both to airlines already based there and to potential new entrants, providing the opportunity to grow the airport's short-haul route network and to add frequencies on the most popular

routes, including links to Middle Eastern and other overseas hubs. The growth in connectivity would be slower than at Heathrow, however, as Gatwick would not have been constrained for so long and hence there would not be the same extent of pent-up demand at the point of expansion.

- 6.41** The possibility of accessing peak hour slots, which have not been available at Heathrow for many years, could also incentivise airlines to switch some services, particularly those which are less dependent on transfer passengers, to Gatwick, releasing capacity at the main hub airport. Given the high yields available at Heathrow and its attractiveness to passengers, however, it is not expected that this would be a substantial element of Gatwick's overall growth, and the likelihood of an airline alliance or network carrier relocating entirely to Gatwick is very low.⁴⁵ The availability of a feed of European travellers via the airport's short-haul network could to some degree offset the loss of transfer traffic for any airline which did move services to Gatwick, especially with support for passengers changing flights provided by the airport, but there would still not be the same level of coordination as available at an airport operating fully as a hub.
- 6.42** For Gatwick expansion to deliver a boost to long-haul connectivity closer to that which would be seen at Heathrow, more substantial changes in the operation of the aviation sector would be needed. That might include significant growth in low-cost long-haul services, although even then these would be more likely to focus on the thickest and most profitable routes given the high level of demand needed to sustain a long-haul connection, or potentially the development of fuller and more formal transfer arrangements between low-cost and full-service carriers.
- 6.43** This analysis is borne out by the Commission's forecasts, which see a faster and more substantial increase in passengers and destinations served at an expanded Heathrow than at Gatwick, particularly in the long-haul market. The overall number of destinations at Heathrow peaks before 2050, however, whereas at Gatwick it continues to grow throughout the forecast period. At national level, in both the carbon-traded and carbon-capped forecasts, the result is that expansion at Heathrow delivers an earlier and more significant increase in the scale and capacity of the UK's overall long-haul network. This can be seen in **Table 6.1** and **Figure 6.2** below:

45 Chapter 3 discusses in more detail the functioning of the aviation market in London and the South East.

Table 6.1: Connectivity impacts of expansion options

	Gatwick Second Runway			Heathrow Extended Northern Runway			Heathrow Northwest Runway		
	Carbon-traded (assessment of need)								
	2030	2040	2050	2030	2040	2050	2030	2040	2050
Passengers at airport (millions)	50	62	82	116	127	131	116	134	138
Daily short-haul destinations from airport (excluding domestic)	75	88	113	86	85	77	86	87	81
<i>Increase from do minimum</i>	8	25	52	18	23	22	18	25	26
Daily long-haul destinations from airport	20	18	21	68	70	75	68	73	75
<i>Increase from do minimum</i>	4	0	1	10	9	12	10	12	12
	Carbon-capped (assessment of need)								
	2030	2040	2050	2030	2040	2050	2030	2040	2050
Passengers at airport (millions)	46	56	69	110	124	129	109	128	135
Daily short-haul destinations from airport (excluding domestic)	74	82	94	85	87	83	85	89	86
<i>Increase from do minimum</i>	5	20	34	18	26	29	18	28	32
Daily long-haul destinations from airport	16	18	20	65	71	72	65	71	73
<i>Increase from do minimum</i>	0	0	1	7	10	9	7	10	10

Source: Airports Commission analysis

Figure 6.2: Increase in long-haul seats resulting from expansion, *assessment of need*

Carbon-traded

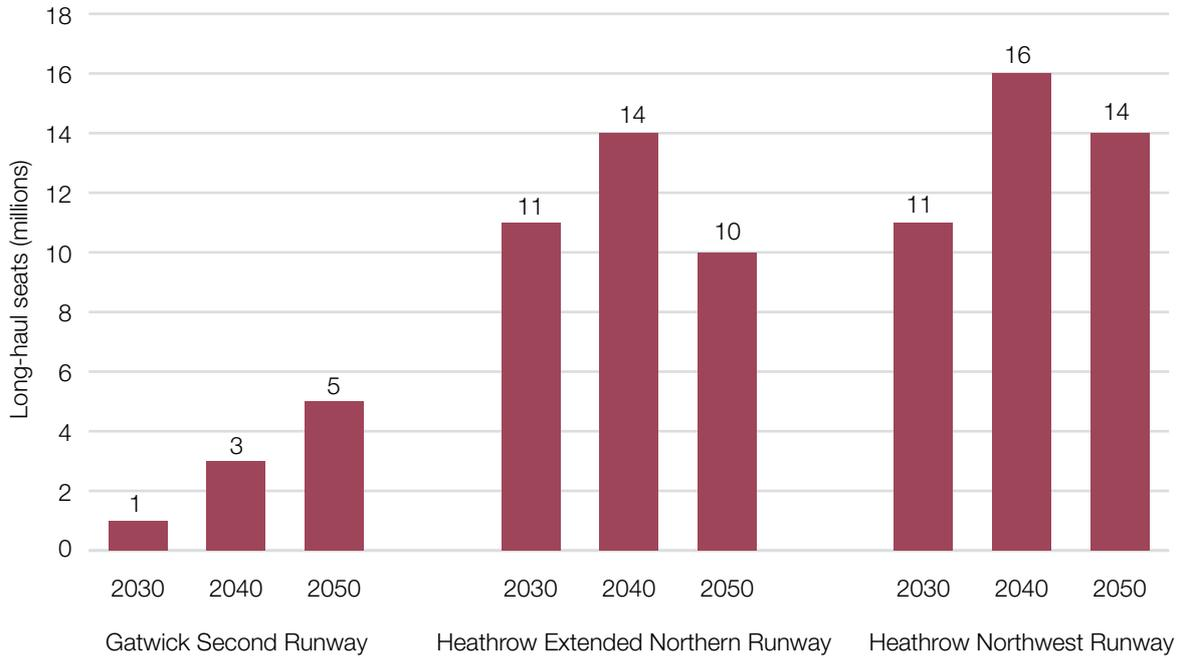

Carbon-capped

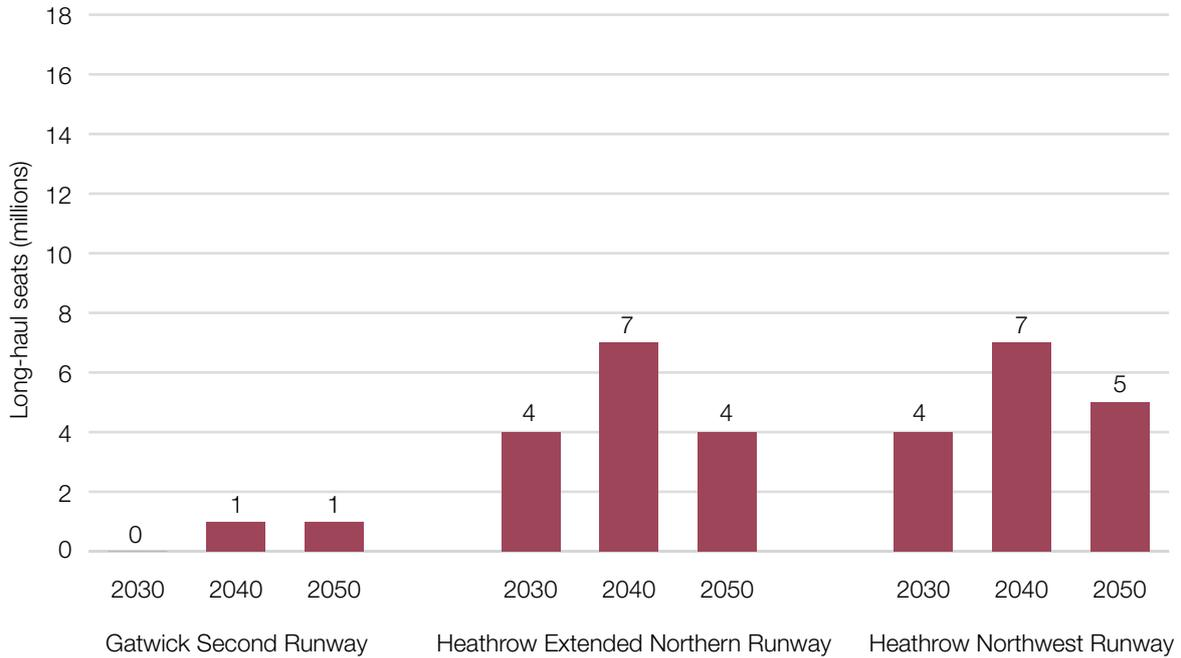

Source: Airports Commission analysis

6.44 The one forecast scenario in which a different pattern is seen is *low cost is king*, where the model is adjusted to allow low-cost carriers to operate long-haul routes and for their passengers to transfer to other services. In addition, a number of long-haul routes are ‘seeded’ at the expanded Gatwick airport to replicate the growth that might be seen in this context when the new runway opens. In this

forecast, while the Heathrow options continue to see strong growth, Gatwick's long-haul performance improves significantly, with as many as 61 daily services from the airport by 2050 in the carbon-traded forecast and 51 in the carbon-capped. Nonetheless, across the London system as a whole and at the national level, even in this scenario Gatwick expansion delivers fewer destinations, both long-haul and short-haul, with regular, daily services than does expansion at Heathrow.

- 6.45** The eastward shift in the global economy's centre of gravity will affect the type of connectivity the country requires. This is as true for freight as it is for passengers; movements of goods and people often move hand in hand as connectivity to new markets develops and firms capitalise on those opportunities. To ensure British businesses can compete effectively in the global market place, a dense network of long-haul routes will be crucial, including links to new and emerging markets. On the basis of the Commission's analysis, that enhanced long-haul connectivity is most likely to be provided by expansion at Heathrow.
- 6.46** Two challenges were considered. The first is that the role of European hubs could be diminished in future as the growing hub airports in the Middle East capture a larger share of global traffic. The second is that the hub model as a whole could be eroded by the introduction of aircraft such as the Airbus A350 and Boeing 787 Dreamliner, which have reduced the level of demand needed to sustain a long-haul route. The Commission does not accept either of these arguments. There are routes and destination which the Middle Eastern hubs are well placed to serve, but the scale of London's origin and destination market means that with sufficient capacity available it is always likely to remain a key focal point in the global aviation system, even in the face of new competition. And analysis of aircraft purchases suggests that the introduction of the Airbus A350 and Boeing B787 may reinforce the hub model as the majority have been purchased by network carriers, enabling them to increase the number of spokes into their hubs.
- 6.47** In terms of domestic connectivity, as described in **Chapter 2**, the trend at both airports has been for the less profitable domestic services to be replaced by international routes. To take just one example, Inverness lost its link to Heathrow in 1997 and its services to Gatwick have declined in recent years. With capacity remaining constrained, this pattern is predicted to continue, whereas expansion would provide the opportunity to reverse it, with the Commission's forecasts showing greater numbers of domestic passengers at either expanded airport than in the baseline.

6.48 By 2050, the number of domestic passengers at an expanded Gatwick is predicted to outstrip that at an expanded Heathrow, although they would be broadly equal until the 2040s. An expanded Heathrow would, however, provide an increased number of domestic passengers with access to a much wider international route network. **Chapter 15** sets out the Commission's proposals to ensure that this strengthening of domestic traffic delivers an increase in the number of routes to key London airports from other areas of the UK, including through more effective use of Public Service Obligations.

Competition between airlines and airports

6.49 The analysis carried out for the Commission by ITF/SEO suggests that expansion of either Heathrow or Gatwick would deliver competition benefits and that, despite increases in the average per passenger charges levied on airlines, fares would be likely to remain unaffected or even to fall. This is due to the significant scarcity rents accruing to airlines operating at Gatwick and Heathrow while those airports remain constrained, which would allow them to absorb any rise in charges rather than pass it on to passengers through increased fares. These dynamics would be triggered by the expansion opportunities offered by increased capacity, especially for new entrants who currently face significant barriers to entry at Gatwick and extremely high barriers at Heathrow.

6.50 These are important conclusions in their own right as the Commission had previously received stakeholder views that expanding the biggest airports in the UK system may lead to anticompetitive (or even monopolistic) outcomes, especially in the case of the hub at Heathrow. The scale of the competition benefits, however, is likely to differ markedly between the short-listed options.

6.51 Expanding Heathrow is expected to deliver higher benefits from competition than expanding Gatwick, for three main reasons:

- first, excess demand is and is expected to remain higher at Heathrow than at Gatwick. Increasing capacity at Heathrow thus has a much higher impact on removing scarcity rents in the airport system;
- second, Heathrow is expected to deliver many more long-haul connections, and the long-haul market is currently much less competitive than the market for short-haul routes. These benefits can also be expected to come on-stream more quickly than at Gatwick due to higher levels of demand; and

- third, Heathrow currently hosts very few low-cost services, in part due to the cost and difficulty of gaining slots at the airport. Expansion would release a large number of new slots at Heathrow for the first time in several decades, which may enable low-cost carriers to build more substantial networks from the airport for the first time.

6.52 The benefits of competition mentioned above are likely to materialise under a variety of the Commission's scenarios, i.e. the benefits of competition from expanding Heathrow can be deemed robust, no matter how the aviation industry may develop, although they would be particularly strong if the low-cost sector enters the market there. In the view of several members of the Commission's Expert Advisory Panel, such a move would be likely to materialise in the event of Heathrow's expansion, and a number of submissions to the consultation also supported that view, notably the response from easyJet which confirmed its interest in potentially entering an expanded Heathrow.

6.53 The competition impacts for the two Heathrow schemes would be broadly similar, only moderated slightly for the Extended Northern Runway given that this option is expected to deliver less capacity in comparison to the Northwest runway.

6.54 Expansion of Gatwick would also deliver competition benefits, but to a lesser degree than at Heathrow as they would predominantly propagate through the already competitive short-haul market. Any significant benefits in relation to competition in the long-haul market from expansion at Gatwick would depend on future changes in the aviation sector which are highly uncertain, although if they were to occur those benefits could be substantial. The benefits would also accrue at a lower rate than at Heathrow due to the less rapid growth in passenger numbers predicted at Gatwick.

Enhancing the passenger experience

6.55 The Commission has considered the benefits of each short-listed option for passengers in relation to the facilities offered inside the terminals at the expanded airport, based on a review of the scheme designs submitted by the scheme promoters and the assessments conducted for the Surface Access and Operational Efficiency appraisal modules.

6.56 A useful metric is the amount of space available per passenger during busy periods across the full range of facilities for passengers from security and check in to restaurants and toilets, as well as lounge areas and shops.

- 6.57** The space provided for passengers differs between the two sites but not between the options at Heathrow. Both schemes at Heathrow would increase the average space available across the campus from its level of 42m² today to 45m², this would be comparable to the level currently offered in Terminal 5 and greater than at other hub airports in Europe. Heathrow's newly built Terminals 2 and 5 are highly rated by passengers, and the proposed expansion would broadly maintain the same quality of experience.
- 6.58** The space available in busy periods at a fully expanded Gatwick would be lower at around 29m² per passenger, which is broadly equivalent to the 30m² available at Gatwick today. In the analysis presented at consultation, the Commission identified that Gatwick Airport Ltd's proposed delivery phasing for its scheme would see space per passenger drop by about a quarter below this level during certain periods, which would impair the passenger experience at the airport. As part of its response to consultation, Gatwick Airport Ltd has proposed an alternative approach to phasing to address this concern, which would only reduce the space available at its lowest point by 10%. The Commission agrees that this may be a more feasible approach, although the final design of any terminal facilities would be a matter for negotiation between the airport, airlines and regulator. Overall, the Commission's view remains that on this measure the proposal for expansion at Gatwick would offer a less good passenger experience than at Heathrow, but one still in line with many comparable European airports.
- 6.59** **Figure 6.3** provides an indication of the relative performance of the Heathrow and Gatwick options in terms of passenger space provided. The upper charts demonstrate how the Gatwick (left hand side) and Heathrow (right hand side) schemes perform in terms of space per passenger and in comparison to other international airports. Each dot on the chart represents an airport or in the case of the assessed schemes a stage of its proposed development from its state today through each of the phases of construction. The higher the dot appears on the chart the more space the airport provides per passenger during busy periods and the further right the bigger the airport. All schemes would continue to offer a similar level of space provision as today. Gatwick's provision of space would be at the low end of large European airports but comparable to the space available in North America, whilst the Heathrow schemes would continue to offer space comparable to other large European airports and in excess of that available in most North American facilities. To give a sense of how these different space provisions compare the lower figure gives a stylised schematic of the departures level of an airport building at busy times, each red dot representing 15 passengers.

Figure 6.3: Relative provision of space for passengers at airports⁴⁶

Gatwick Second Runway

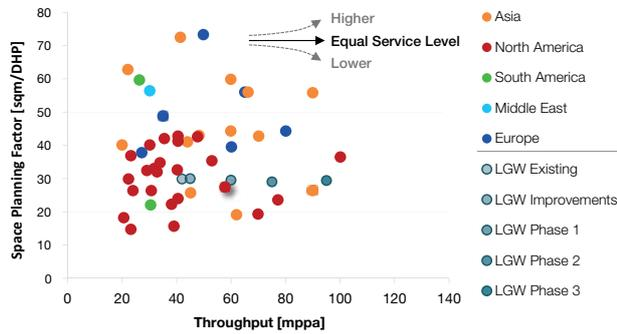

Heathrow Extended Northern and Northwest Runways

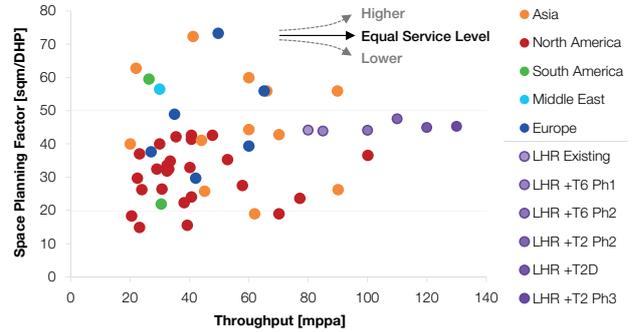

30m²/DHP

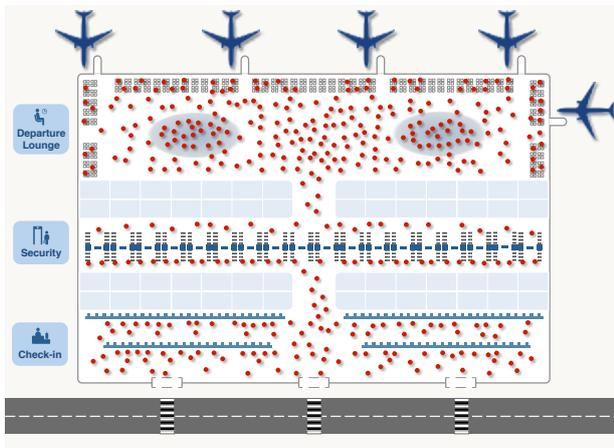

45m²/DHP

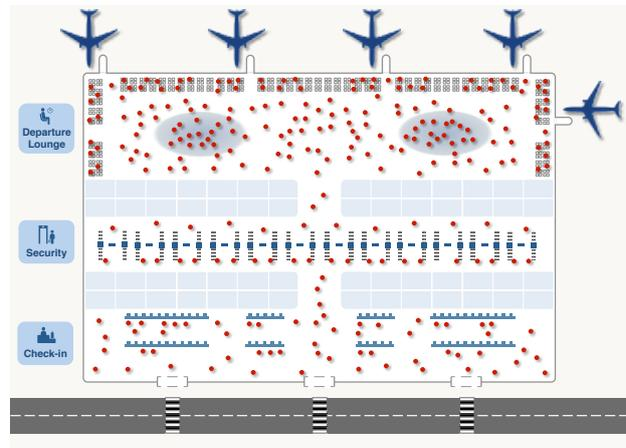

Source: LeighFisher

6.60 Surface access provision is discussed in **Chapter 8**, but for all schemes the proposed surface access strategies are expected to be able to accommodate forecast levels of demand, although with high levels of congestion at peak hours on all major links. These strategies include planned improvements such as Thameslink and Crossrail but also scheme specific enhancements such as Southern Rail Access to Heathrow and a range of road enhancements at both Heathrow and Gatwick.

⁴⁶ In the stylised departure level diagram, the check-in hall, passenger security and airside departures lounge are represented with allowance for “back of shop” facilities. The “back of shop” area is held consistent between the schematics. In practice, however, an airport operator would likely choose to reduce this area to reduce the impact on space used to directly service passengers’ needs such as retail or food outlets. The displaced facilities would need to be reprovided in other buildings. Maintaining the same back of shop area on the schematic aids comparison and avoids the false implication that the same area for these facilities is not required.

- 6.61** In terms of the passenger experience, the highest levels of congestion would be seen with new capacity at Heathrow. Either Heathrow scheme would place additional demand onto a network that in 2030 is already likely to be heavily used. As a result, even with the additional proposed improvements, the road links serving the airport would often be highly congested, and passengers travelling into London by rail would see significant levels of crowding in peak hours as they approach the centre of the city. These impacts would be marginally greater with the Northwest Runway scheme, as it enables a larger increase in passenger numbers at the airport, but as the crowding and congestion are driven primarily by background demand i.e. non-airport traffic, the difference between the two Heathrow schemes is small. The transport networks serving Gatwick are forecast to be less heavily congested by 2030, although still crowded in peak hours.
- 6.62** The higher levels of congestion seen on the links serving Heathrow airport will mean that these links are more susceptible to minor disruption than those around Gatwick. On the other hand, whilst access to Gatwick will be easier when the networks are running normally or with slight perturbations, major incidents could have a profound effect. With only one railway line and one strategic road corridor to the airport it will suffer more in the event of major incidents, causing significant disruption due to the limited alternative options. Heathrow on the other hand with four rail and light rail routes into London and at least two strategic road corridors would be better able to respond to major disruptive events such as the complete loss of a transport artery.
- 6.63** Overall, each of the short-listed options would deliver significant benefits for passengers as a result of reduced fares, more frequent services, links to new destinations and better surface access. Increasing capacity would also reduce delays as it would enable the expanded airport to deal more efficiently with disruption and reduce the need for stacking. In the next chapter, the Commission's economic analysis shows that the value of these benefits to passengers, ranges from £47-55 billion across the three schemes in the *assessment of need* carbon-traded scenario, and a roughly a third less when CO₂ emissions are constrained to the Committee on Climate Change's planning assumption. A summary of these benefits is provided in **Table 6.2** below.

Table 6.2: Benefits to passengers through reduced fares, new routes, increased frequencies etc, present value £ billion, 2014 prices⁴⁷

	Gatwick Seccond Runway	Heathrow Extended Northern Runway	Heathrow Northwest Runway
Carbon-traded, assessment of need			
UK business passengers	10.5	11.5	13.4
UK leisure passengers	22.4	17.4	20.5
Foreign business passengers	5.0	5.9	6.8
Foreign leisure passengers	7.6	6.5	7.6
International-to-international passengers	1.7	5.1	6.5
Total passenger	47.1	46.5	54.8
Delay benefits	2.4	0.8	1.0
Carbon-capped, assessment of need			
UK business passengers	6.2	6.8	7.7
UK leisure passengers	13.0	9.8	11.4
Foreign business passengers	2.7	3.5	4.0
Foreign leisure passengers	4.4	3.8	4.4
International-to-international passengers	0.9	5.1	6.2
Total passenger	27.2	29.1	33.6
Delay benefits	2.6	2.4	3.0

6.64 The monetised benefits to passengers are greatest from the Heathrow Airport Northwest Runway scheme, with this scheme performing particularly strongly in relation to benefits for business passengers. The Heathrow Airport Extended Northern Runway scheme shows the lowest overall benefits, because it provides a smaller increase in capacity and therefore fills up more quickly than the others schemes, but still delivers stronger benefits for business passengers than expansion at Gatwick.

The benefits of expansion for air freight

6.65 The UK airports system is also used by those who transport goods, both air freight companies providing shipment services and UK firms who rely on air freight to

⁴⁷ The carbon-capped delay benefits are generated using the approach published for consultation in November 2014. The remaining carbon-capped benefits are generated using an approach developed since consultation set out in further detail in **Chapter 7** and in the *Business Case*.

supply them with components and finished goods and to deliver their products to markets across the world. Air freight is generally used to ship goods that are small and high value or which need to be shipped over long distances quickly. Key sectors for air freight include perishables such as food and flowers and pharmaceutical products and medicines that need to be delivered in controlled environments within short shelf lives, as well as fast evolving high-tech products where several weeks of sea transit from the Far East might represent a significant proportion of the product's sales life.⁴⁸

- 6.66** Whilst all three schemes provide increased freight capacity, the Heathrow options are better placed to accommodate high frequencies of less thick long-haul connections and are thus more attractive for freight handling. Another attractive feature of Heathrow for the freight sector is its central position on the strategic road network. As illustrated by **Figure 13.3** (in **Chapter 13**) a significant cluster of freight and logistics businesses have developed around Heathrow and in the Thames Valley region. Expansion at Heathrow would build on this success.
- 6.67** In addition to the substantial cargo handling facilities already in place at the airport, the Northwest Runway scheme's masterplan, with its provision for an expanded freight handling capacity within the airport boundary, has been designed to handle a significant increase in the airport's freight operations. It could accommodate a rapid throughput of freight-handling across all areas of its airfield. In contrast, the Extended Northern Runway scheme's masterplan does not specify additional freight-handling capacity within the airport boundary, so any such development, if needed, would have to be located elsewhere, reducing the efficiency of freight operations.
- 6.68** As there currently is only a limited freight-handling operation at Gatwick, any significant growth in the cargo sector at Gatwick would require a significant investment by third parties to develop freight-handling facilities. The scheme's masterplan does not explicitly provide for additional freight-handling capacity, but there is sufficient space to provide such capacity if required.
- 6.69** The Commission received a number of responses in consultation from freight operators emphasising their requirement and appetite to expand at Heathrow, whereas the degree to which freight operators would invest in additional capacity at Gatwick is more uncertain. The airport's position to the south of London and limited connection to the strategic road network may dampen demand, as would the slower growth predicted in long-haul services. There is also much

48 A more in depth explanation of the industry and how it operates in the UK is set out in *The Air Freight Industry in the UK* published alongside the Commission's *Interim Report*.

less of a foundation on which to build with relatively few logistics providers based in the vicinity of the airport. Expansion at Gatwick would still provide new opportunities for freight users, as the number of routes and carriers grows, but even if a more substantial freight industry were to develop, this would take a significant time to emerge.

Alignment with spatial and economic development strategies

- 6.70** By virtue of the economic benefit that expansion would provide to the immediate local and broader regional and national economies, all three schemes would help to deliver economic growth and employment in line with the priorities of many local authority and regional development strategies, although the airports' environmental impacts mean that expansion is still often opposed. The short-listed schemes would also support the strategies of Local Enterprise Partnerships and other business groups in the areas around the short-listed airports.
- 6.71** Adding runway capacity at Heathrow is forecast to deliver significant growth in local employment through additional direct, indirect and induced jobs, totalling around 64,000-66,000 (Extended Northern Runway scheme) or 75,000-78,000 (Northwest Runway scheme) in 2050.⁴⁹ A number of nearby local authorities, notably Ealing and Slough, have current unemployment rates above the London average (and close to or above the national average); employment created through expansion would offer a local source of jobs.
- 6.72** The areas identified for significant growth in employment and housing in the London Plan include the Heathrow Opportunity Area, which is described as having capacity for 12,000 jobs. The Old Oak Common Opportunity Area in West London would also be well connected to Heathrow via fast rail links.
- 6.73** Local authority plans note the benefits that Heathrow provides as a driver and catalyst of economic activity. For example, the Hillingdon Local Plan refers to Heathrow as a 'key employment area' and Hounslow's plan refers to the 'economic stimulus it provides'. It is important to note, however, that both the London Plan and these plans refer to the airport's current activities and expansion is opposed in all three cases, due to environmental impacts. This opposition is not universal, however, with other nearby local authorities, notably Slough and Spelthorne, supporting expansion as long as appropriate conditions are met.
- 6.74** The size of the opportunity presented by expansion at Heathrow will depend upon future growth scenarios, but the Commission estimates that it is likely to be

49 The ranges for numbers of additional jobs represent the outputs of both carbon-capped and carbon-traded forecasts.

significant even at the lowest end. Surface access developments would mean that employment opportunities at an enlarged Heathrow are open to a wide catchment area, including to the growing populations in the east of the city, which would have convenient access to jobs at and around the airport via Crossrail. This link will, for example, bring both Stratford and the Royal Docks within 45 minutes of the airport.

- 6.75** London is forecast to see high rates of population growth over the coming decades, with its population rising to more than 10 million by 2036. Combined with the substantial labour market flexibility seen in the capital, the creation of such a large amount of employment would provide a welcome contribution to ensuring such growth is sustainable. Therefore this additional employment would appear to offer a positive contribution rather than a significant challenge.
- 6.76** Expansion at Gatwick is also expected to contribute to supporting growth in employment, totalling around 13,000-32,000 additional jobs by 2050. The rate of growth would be slower, however, than at Heathrow with only 4,000-7,000 jobs created by 2030.
- 6.77** At the regional level, expansion at Gatwick would support local and regional development strategies, by providing increased employment in the immediate vicinity and supporting economic development in the Wandle Valley corridor identified in the London Plan.
- 6.78** The airport's growth would also foster development of the wider 'Gatwick Diamond' area, covering Brighton to the south, Tunbridge Wells to the east and Croydon to the north, with greater international connectivity helping local businesses reach growth markets more quickly and more affordably. For this reason, expansion is supported by regional business groups and by boroughs which could benefit economically from the second runway. These include East Sussex and Croydon, which has been identified as an Opportunity Area and has a stated ambition to grow into an 'Airport City'.⁵⁰
- 6.79** The strong links into central London and further afield provided by the Brighton Main Line and the Thameslink network would provide convenient access to the airport from other Opportunity Areas such as Kings Cross and London Bridge, and the direct link to Crossrail at Farringdon would connect the airport to the London's key east-west growth axis. Gatwick would not, however, have a direct rail link to anywhere further east.

⁵⁰ Croydon's 'Airport City' concept is the borough's plan to capitalise on its transport links to airports (particularly Gatwick Airport) as part of its economic development plans, attracting businesses with the need for international connectivity to make use of the office space that Croydon has available.

Valuing the strategic benefits of airport expansion to the UK economy

- 6.80** Expanding airport capacity would have a significant impact on the UK's economy. New passenger and freight flows into and out of the country would impact on expenditure across a range of sectors; new routes and services may enable gains from trade to increase with better connectivity to different countries and regions, growing imports and exports; more frequent and convenient aviation services help improve business productivity; and lower cost travel will boost demand in the short term, enabling more business, but also feed through to higher productivity and funds to be invested elsewhere affecting the economy in the medium to long run.
- 6.81** The Commission has sought to identify the scale of impact of each option in terms of GDP, through the use of a Spatial Computable General Equilibrium (S-CGE) model. This has shown that the GDP benefits delivered through expansion, as it fosters further investment across the economy, could be very significant, for example adding between 0.5-0.75% to UK's GDP in 2050 in the carbon-traded *assessment of need* scenario (**Figure 6.4**). In present value terms over 60 years, this would amount to an addition of £89 billion to GDP for the Gatwick Second Runway Scheme, £131 billion for the Heathrow Extended Northern Runway and £147 billion for the Heathrow Northwest Runway (**Figure 6.5**).

Figure 6.4: GDP impact of expansion, carbon-traded, *assessment of need*

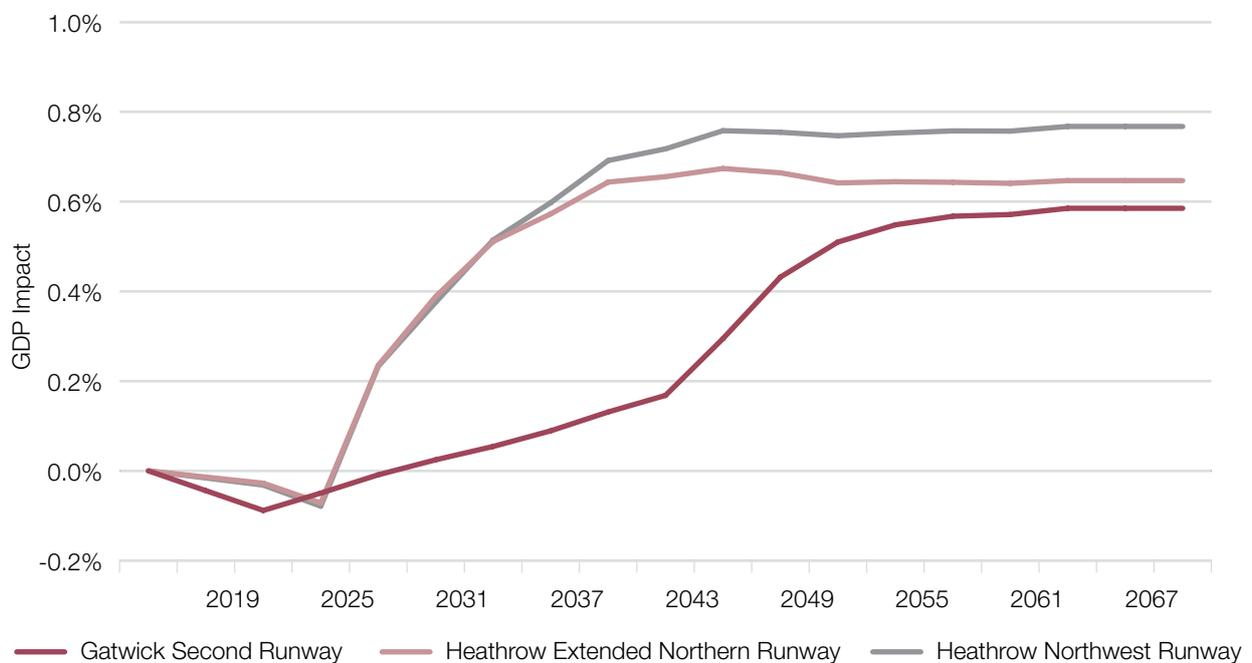

Source: PwC

- 6.82** These benefits exclude the construction impacts, as the displacement of investment from elsewhere in the economy is difficult to estimate. They rise significantly in the *low cost is king* and *global growth* scenarios and are materially lower in the *global fragmentation* scenario. The differences are due to the underlying assumptions around the rate of economic growth as well as assumptions about changing airline operating models and travel patterns at the airports themselves.
- 6.83** The Commission has also undertaken further work since consultation to consider the GDP impacts of the scheme with carbon emissions from aviation constrained to the CCC's planning assumption of 37.5MtCO₂ in 2050. This is important in ensuring that the case for expansion is not dependent on emissions from aviation rising to a level which may not be compatible with the achievement of the UK's broader carbon targets.⁵¹
- 6.84** The GDP impacts with CO₂ emissions constrained are broadly similar to the carbon-traded results under both Heathrow schemes, falling by 12-21%. This is mainly because expansion still delivers an increase in long-haul flights to high-growth regions of the world. Constraining emissions has a more significant effect on the Gatwick Second Runway scheme, however, where overall GDP benefits fall by around 50%, although the scheme continues to have a positive net impact on GDP of around £44 billion over 60 years. A key factor in this reduction in benefits is the difference in growth between more productive long-haul routes and short-haul services, which tend to serve a higher proportion of outbound leisure travellers.

51 The Commission's approach to estimating economic benefits in a world where carbon emissions are restricted to the level of the CCC's planning assumption (carbon-capped) is set out in more detail in **Chapter 7** and in the *Business Case and Sustainability Assessment*.

Figure 6.5: Capping carbon emissions reduces total GDP impacts, *assessment of need*, present value £ billion 2014 values

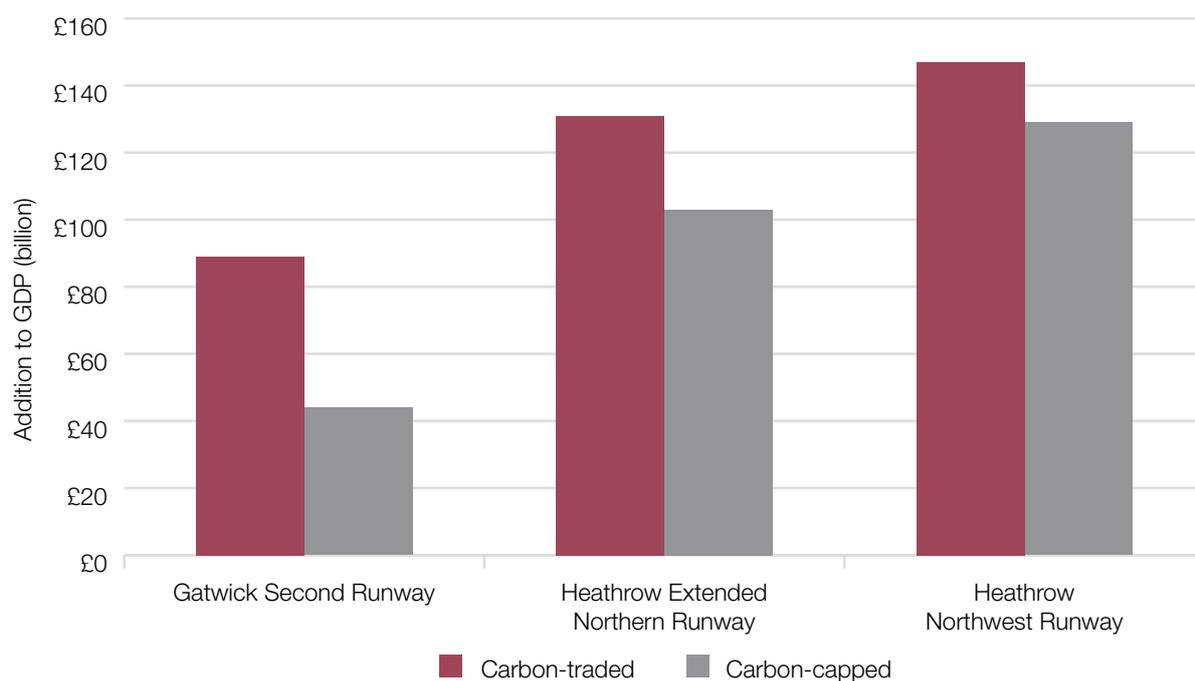

Source: Airports Commission analysis

- 6.85** In response to consultation, a sensitivity test was undertaken to assess the extent to which the relative difference between the schemes is driven by the split between inbound and outbound passengers, which was assumed to remain constant at each airport in the analysis published for consultation. This showed that with passenger demand at Gatwick adjusted to reflect the average inbound/outbound split across the London airport system, as opposed to the lower proportion of inbound passengers currently seen at the airport, the GDP benefits resulting from expansion rise.
- 6.86** While it is reasonable to assume, however, that the inbound proportion would change at an expanded Gatwick, particularly as some flights from a constrained Heathrow move across, the exact size of this change is difficult to predict and there is little evidence to suggest it might reach today's London average level. Furthermore, even with the inbound/outbound split adjusted to the London average level for all three schemes, Gatwick's impacts remain materially smaller than those from the Heathrow Northwest Runway scheme.

Conclusion

- 6.87** All three schemes **provide additional capacity that facilitates connectivity in line with the assessment of need**. It is very likely, however, that expansion at Gatwick would provide significantly fewer new long-haul destinations and associated benefits, than Heathrow. The Heathrow Northwest Runway is expected to deliver the highest levels of long-haul connectivity, both in terms of the number of new destinations and frequencies served. Pooling these destinations at one location would have significant benefits to all UK passengers, particularly those who would like to travel to long-haul destinations from the UK's regions, as they would gain access to a wider long-haul route network. Due to its lower capacity in comparison to the Northwest Runway, the connectivity benefits provided by the Extended Northern Runway scheme are relatively lower.
- 6.88** All schemes as assessed by the Commission have potential to **improve the experience of passengers and other users of aviation**. However, for freight users the additional long-haul daily destinations and existing cluster of airfreight businesses mean Heathrow is likely to deliver stronger benefits than Gatwick. For passengers, Heathrow expansion would provide a more pleasant terminal experience and more resilient surface access links, but higher levels of crowding and congestion would be seen on these in peak hours.
- 6.89** All schemes have the potential to deliver significant **competition benefits to both users of aviation and the wider economy**. These are greatest for the Heathrow Northwest Runway scheme. First, the excess demand in the London airport system is greatest at Heathrow, leading to significant scarcity rents and higher average fare levels. Expanding Heathrow would result in potentially reduced fares to passengers, particularly those who are more price-sensitive. Expansion at Heathrow would also enable new carriers to enter the airport further driving the benefits of competition, particularly in the currently constrained long-haul market. These benefits would be even higher if low-cost carriers entered the airport and offered low-cost alternatives to short- or even long-haul routes.
- 6.90** All schemes have been shown to have a good high level fit with **local economic and spatial development strategies**, in relation to their impacts on employment and economic growth, but they are often still opposed in such plans and strategies due to the airports' environmental impacts. Heathrow expansion would create more jobs more quickly, and in an area of higher average unemployment, than Gatwick. Employment generated from all three schemes would be accessible from a range of Opportunity Areas in the capital, but Heathrow would be better connected to the growing districts of East London due to its direct Crossrail link.

- 6.91** On this basis, the Commission's overall conclusion is that the Heathrow Airport Northwest Runway scheme performs most strongly in relation to the Strategic Fit appraisal module. It would deliver the greatest increase in connectivity, particularly with regard to strategically important long-haul connections, would provide a world-class passenger experience and support growth in airfreight more effectively than expansion at Gatwick; and it would deliver more significant benefits in terms of increased competition and reduced fares. It would also provide a significant boost to employment, supporting local and regional economic growth and providing opportunities for London's increasing population.
- 6.92** The other short-listed schemes would both provide valuable strategic benefits. Those of the Extended Northern Runway scheme would be broadly in line with those of the Northwest Runway, but reduced in scale due to the smaller capacity increase provided and the more limited scope to enhance freight operations at the airport. Those from Gatwick would be more focused on expanding short-haul European travel, with significant changes in industry structure needed to see a substantial increase in long-haul connectivity. Expansion at Gatwick would also have a positive impact on airfreight, competition and local employment, but these benefits would be smaller than those provided by expansion at Heathrow.
- 6.93** These results are in line with the Commission's macro-economic analysis of GDP impacts, which show a substantial impact of expansion at Gatwick, estimated to be in the region of 0.5% in 2050, amounting to £89 billion over the assessment period. The impact of expansion at Heathrow would be higher still with increases in GDP estimated to be in the order of 0.65-0.75% in 2050, amounting to £131 billion over the assessment period for the Extended Northern Runway and £147 billion for the Northwest Runway.

7. Economic Impacts Assessment

Introduction

7.1 The *Appraisal Framework* set the following objectives in respect of the local and national economy:

- **to maximise economic benefits and support the competitiveness of the UK economy;**
- **to promote employment and economic growth in the local area and surrounding region;** and
- **to produce positive outcomes for local communities and the local economy from any surface access that may be required to support the proposal.**

7.2 In addition, this chapter assesses performance against one further objective, which draws together the full range of the Commission's economic assessments:

- **to make efficient use of public funds, where they are required, and ensure that the benefits of schemes clearly outweigh the costs, taking account of social, environmental and economic costs and benefits.**

7.3 As discussed previously, continuing growth in demand for aviation will see the existing constraints in the UK's air transport system, and particularly in the London airport sector, exacerbated.

7.4 As a consequence, both business and leisure passengers will, over time, pay increased fares, experience reduced availability of flights and falling connectivity, meaning passengers have to either travel further to second or third choice airports in order to fly where they need to or not travel at all. Once at the airport, passengers can expect to experience longer ground holding, a worsening passenger experience and more delays and cancellations, as the ability of the system to cope with disruption reduces. Businesses looking to expand by trading with other nations will find new opportunities harder to connect with as connectivity falls and costs rise, and the clusters of businesses that have been established around the UK's major airports will weaken, as these locations become less attractive to high-performing firms.

- 7.5** There is a clear benefit to the UK economy from tackling these issues, which would deliver a better-functioning international air transport network and eliminate or reduce the problems associated with the congested system in the South East.

Methodology

- 7.6** The strategic fit assessment considered the impact of removing these constraints by adding runway capacity at Heathrow or Gatwick from a macroeconomic perspective, looking at the impact on the UK's GDP once its effects had been felt throughout the economy. In contrast, the economy assessment considers these impacts from the bottom up, starting with the passenger and user, and tracking how they feed through specific areas of the economy to develop a broadly conventional welfare analysis. Both approaches have their own merits and should be viewed as complementary pieces of analysis, undertaken using different methodologies, and not as additive.
- 7.7** The national economic impacts associated with expansion assessed at consultation included the direct impacts on passengers, users and producers and the benefits from reducing delays. A detailed review of how increased capacity would impact the local economies surrounding the airports in question was also carried out.
- 7.8** Since consultation, the economic analysis has been developed in several ways. Notably, a methodology for assessing the wider economic impacts associated with increased productivity from trade and agglomeration amongst other things has been developed, which can be incorporated into a conventional economic analysis. It draws upon concepts from the Department for Transport's WebTAG guidance, but the approach has been adapted to make it suitable for assessing the impacts of airport expansion.
- 7.9** The Commission has also developed an approach to assessing the economic benefits of expansion with carbon emissions from aviation restricted to the planning assumption recommended by the Committee on Climate Change (CCC), which avoids the technical challenges identified in the *Consultation Document*. In addition, the methodology for calculating delays benefits has been updated and improved, and the analysis of local economic impacts has been reviewed in light of responses to the consultation.
- 7.10** The overall structure of the Commission's economic analysis is set out in **Figure 7.1:**

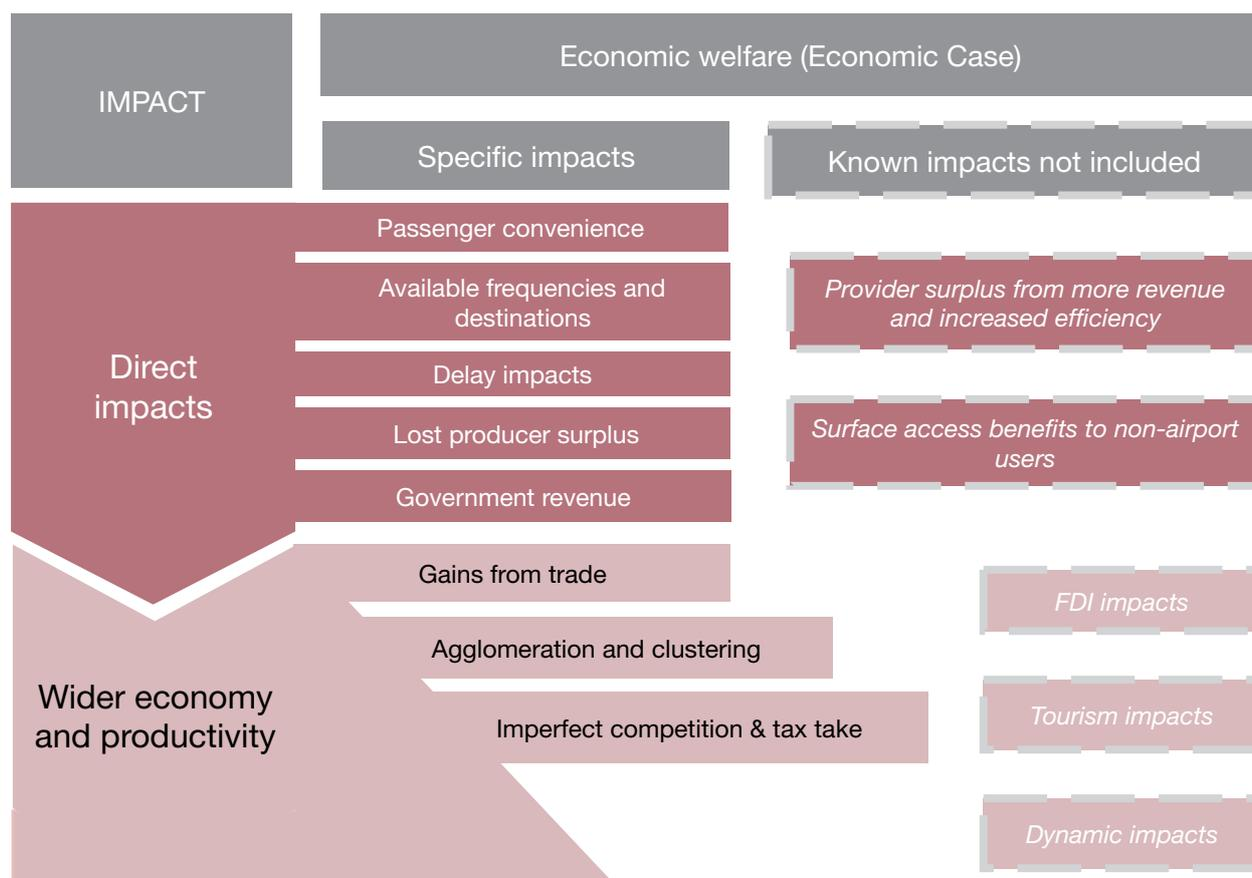
Figure 7.1: Economy impact analysis framework

7.11 The detailed methodologies by which the economic assessments have been carried out are described in a number of technical reports available on the Commission website.⁵² This includes updated versions of a number of the reports prepared for consultation, showing where additional work has been undertaken.

Incorporating the CCC's planning assumption

7.12 The CCC has recommended that in order to ensure that aviation makes a proportionate contribution to the achievement of the UK's overall target for reducing climate change emissions, a planning assumption should be adopted that emissions from the sector should not exceed 2005 levels by 2050. The CCC's 2012 International Aviation and Shipping Review states that "The key driver of emissions reduction will be EU or global policies, and should not be unilateral UK approaches;

⁵² In addition to the *Economy and Local Economy reports* published for consultation see the following reports published alongside this document: *Economy: Updated Transport Economic Efficiency Impacts*, *Economy: Updated Delay Impacts Assessment and Methodology*, *Economy: Wider Economic Impacts Assessment*, *Economy: Expert Panelist Wider Economic Impacts Review*, *Economy: Carbon Policy Sensitivity*, *Local Economy Impacts*, *Local Economy: Impacts Assessment Post Consultation Update*, and *Local Economy: Expert Panelist Review*

therefore [this assumption] should be kept under review with respect to the evolving international framework, and changed as appropriate.”

- 7.13** In order to understand the implications of this planning assumption for future aviation demand, the Commission developed a new approach to forecasting, which treated carbon emissions as a constraint rather than as an output of the forecasting model. These carbon-capped forecasts demonstrated that runway capacity would be stretched to its limits in the South East of England over the next fifteen years, even with policies in place to manage the growth of aviation emissions. This analysis formed the core of the assessment in the *Interim Report* that one net additional runway would be needed in the South East by 2030.
- 7.14** This carbon-capped approach to forecasting has been incorporated into many of the Commission’s assessments of the three short-listed schemes for new runway capacity, including its analysis of the enhanced capacity and connectivity provided by each option, their noise impacts and their commercial viability.
- 7.15** As explained in the *Consultation Document* published in November 2014, however, incorporating the carbon-capped forecasts into an economic assessment presented a number of technical challenges. For that reason, the economic analysis presented for consultation was based on the carbon-traded forecasts, which apply the DECC central carbon price to aviation emissions, with the consultation document noting that the Commission intended to carry out further work to incorporate the CCC’s planning assumption more fully into its economic analysis prior to the *Final Report*.
- 7.16** To complete that work, and in response to a number of submissions to the consultation, a range of approaches to gain a better understanding of the implications of the CCC’s planning assumption for each scheme’s economic case have been developed and tested.
- 7.17** First, the effect on the economic benefit of each scheme of reducing underlying demand to a level at which overall UK aviation emissions with expansion would not exceed 37.5MtCO₂ was assessed. Whilst conceptually this would be consistent with UK aviation being subject to some form of trading scheme, in line with the view in the CCC’s 2012 report on international aviation and shipping, no trading or purchase of offsets has been included to allow UK aviation emissions to rise above 37.5MtCO₂. The economic impacts for passengers, producers, Government revenues (transport efficiency impacts) and the wider economy have been generated through this approach and are incorporated into the analysis below. Unless stated otherwise they are referred to as carbon-capped results. These results and the approach to

handling carbon emissions are discussed in more detail in the report *Strategic Fit: Updated Forecasts*.

- 7.18** Second, an indicative set of policies was identified that could enable aviation emissions for each short-listed scheme to be restricted to a level consistent with the planning assumption, which were then used as the basis for sensitivity testing. For the Gatwick option, the changes required are modest, an increase in the carbon price (to around £330 per tonne in 2050) and a level of biofuels usage below the CCC baseline are sufficient to constrain emissions to 37.5MtCO₂. For the two Heathrow schemes, a more substantial package of measures would be needed, including for example the same carbon price and significantly higher biofuels usage, plus a range of operational efficiency improvements, all of which represent technologies or practices understood today but as yet to be implemented on a wide scale.
- 7.19** That approach produces greater benefits to passengers from flying more conveniently or at lower cost and greater revenues to Government. However, the increased costs to airlines and their supply chains coupled with the cost of the policy measures adopted also need to be considered. The net results are £4.5 billion for the Gatwick option (£1 billion higher than under the first approach) and £8.9-10.2 billion for the two Heathrow schemes (broadly similar to the first approach). It also produced higher wider economic benefits for all three proposals – £2.8 billion higher for Gatwick and more than £4 billion higher for the two Heathrow schemes. These results do not alter the Commission's broader conclusions on the relative economic performance of the three schemes.⁵³
- 7.20** Finally, the Commission endeavoured to assess the case for each scheme in a context in which emissions reach 37.5 MtCO₂ in 2050 both in the baseline and with expansion, but without defined policy measures as described above. The benefits calculation tools available, however, were primarily designed to identify and value impacts associated with increasing levels of air travel and did not have the functionality to assess accurately benefits arising as a result of changes in the types of journey made. Whilst it was possible to calculate delay benefits on this basis, the analysis did not provide robust estimates of the remaining direct impacts along with wider economic impacts.

53 For more information see – *Economy: Carbon Policy Sensitivity Test*

7.21 In order to ensure that its recommendations are robust to the widest range of potential carbon outcomes, the Commission therefore considered whether there would be a case for expansion even if the modelled transport economic efficiency element of the benefits were reduced to zero. Even in this extreme scenario the strategic benefits in terms of enhanced international and domestic connectivity, reliability, resilience and competition would justify proceeding. In addition the UK's climate commitments are likely in future to be extended beyond the 2050 timeline of the Climate Change Act and the Commission's demand forecasts. The calculation of benefits is applied over a standard transport appraisal timeframe of 60 years from scheme opening meaning that a proportion of benefits are generated in the period after 2050. The sensitivity of these impacts to assumptions about demand growth beyond 2050 has been tested for the carbon-traded case and did not alter the Commission's conclusions. Further details are available in *Economy: Updated Transport Economic Efficiency Impacts* and *Economy: Wider Economic Impacts Assessment*.

Assessment

Economic benefits to passengers

7.22 Expansion of congested airports creates benefits for passengers by lowering or removing the inconvenience and cost associated with using that airport. This is due to airlines and other providers no longer being able to charge scarcity rents or deliver a lower quality of service than those in a more competitive environment. Also, more frequent flights and new destinations can be made available, government revenues increase as aviation consumption grows, and delays are reduced as disruptive events can be more efficiently managed.

7.23 For existing passengers, reducing delays and improving airline efficiency makes travelling by air simpler, cheaper and better quality, often enabling them to fly from a more convenient airport or at a more convenient time. This reduces the cost of travel. New passengers benefit from being able to make journeys that they would otherwise have been prevented from undertaking.

7.24 All the options lead to considerable benefits for passengers and other users, as well as delivering reduced delays, with the Northwest Runway at Heathrow having the greatest impact, as it is the scheme which tackles the heaviest congestion most fully. **Figure 7.2** depicts the relative size of the benefits for passengers across schemes and carbon approaches.

Figure 7.2: Direct economic benefits of expansion, *assessment of need*, present value £ billion, 2014 prices

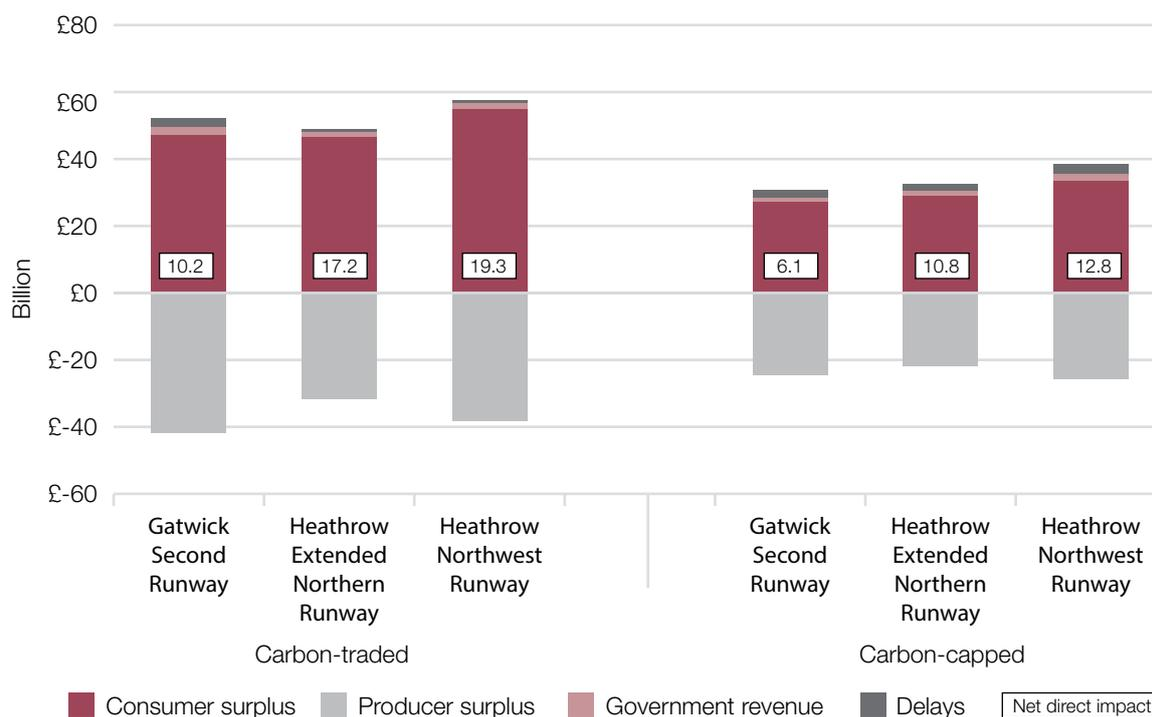

Source: Airports Commission analysis

- 7.25** The reduced costs and service improvements enjoyed by passengers (consumer surplus) as a result of expansion have been interpreted partly as a transfer from the providers of aviation services to passengers and included in the economic assessment as a producer disbenefit to be netted off from the total benefits (producer surplus). These net calculations, however, are likely to be an underestimate since they do not take account of the productivity gains which might be driven by improved efficiency from greater competitive pressures for airlines and aviation service providers. Consumer benefits to freight users would be additional.
- 7.26** As with the analysis of connectivity in the previous chapter, in a future in which low-cost carriers move strongly into the long-haul and transfer markets, modelled through the carbon-traded *low cost is king* scenario, the relative performance of the schemes shifts. In this case, Gatwick expansion outperforms the Heathrow schemes, although all three still deliver strong benefits. This applies in both the original carbon-traded *low cost is king* scenario and in the sensitivity test, in which central macroeconomic factors are used.
- 7.27** The industry developments needed to deliver these results would, however, mark a significant departure from current practice and their plausibility is highly uncertain. It would therefore be risky to place particular weight on this one scenario in assessing the schemes' economic benefits.

Expanding airports leads to benefits in other sectors across the wider economy

- 7.28** As well as providing direct benefits for passengers, expansion in airport capacity provides better access to foreign markets, facilitates gains from trade and encourages greater exchange of knowledge and technology. Greater competition from other countries can drive increased investment and efficiency, better use of resources and enhanced choice for consumers, thus improving the overall level of productivity and innovation in trade-related sectors of the economy.
- 7.29** The change in connectivity offered by expansion would also attract more businesses requiring better international links to cluster around the airport, together with their supply chains, leading to growing agglomeration impacts around the airport and additional productivity increases in these sectors. This effect is clearly visible today, such as along the M4 corridor where many businesses in sectors which place a high value on being close to an international gateway such as Heathrow have clustered – for example in the software sector, global companies such as Microsoft, Oracle, Baan and SAP.
- 7.30** Many consultation respondents argued that these wider economic impacts of aviation expansion should be incorporated into the Commission’s conventional economic analysis, in addition to being analysed through its S-CGE work. In response, the Commission has expanded its assessment to value, amongst other things, the increase in productivity through gains from trade and agglomeration. Further details are set out in the report *Economy: Wider Economy Impacts Assessment* but are summarised for all three schemes in **Figure 7.3**.

Figure 7.3: Wider economic impacts of expansion, *assessment of need*, present value £ billion, 2014 prices⁵⁴

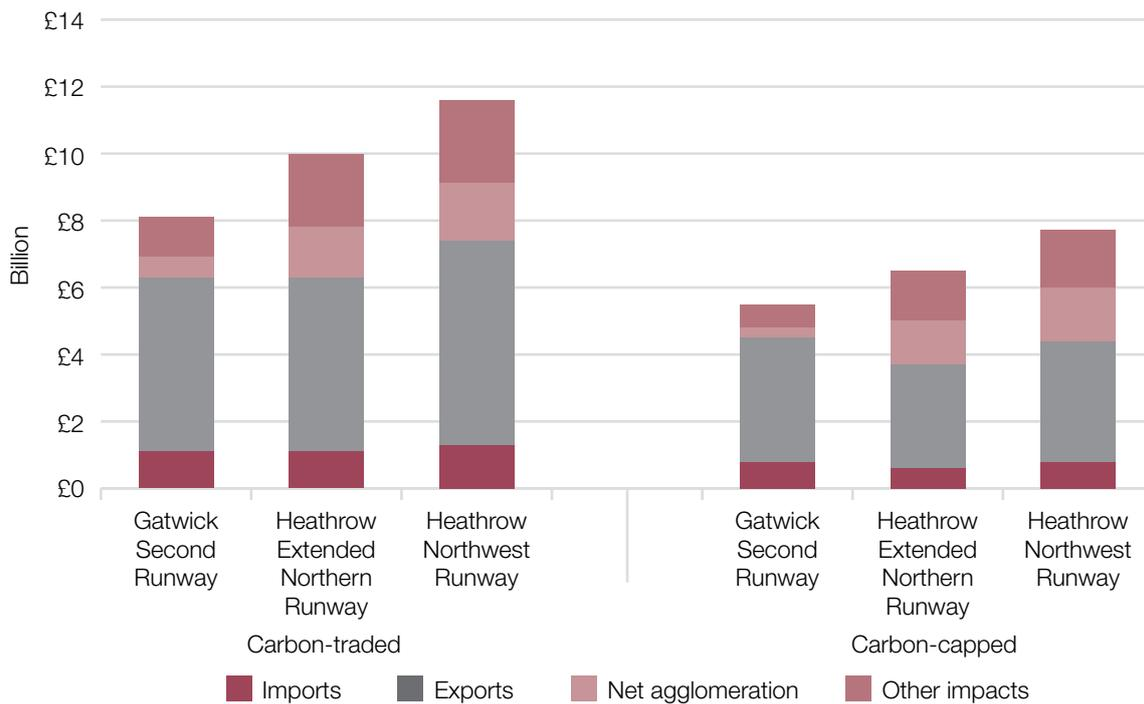

Source: Airports Commission analysis

7.31 The key difference between the wider economic impacts of the schemes is the agglomeration benefit of the Heathrow schemes. At Heathrow, the expansion proposals are building on existing business clusters, such as the technology and pharmaceutical firms that are already located around the airport. In contrast, there is comparatively little business clustering related to Gatwick Airport at present, due in part to its traffic mix. As Gatwick attracts more business passengers after expansion, clustering effects begin to occur, but it generates fewer agglomeration benefits, as it starts from a lower base.

Impacts on the local economy

7.32 The economic impacts described above are calculated at a national level, taking account of the full extent of changes to travel patterns and business decisions across the country as a result of expansion. The short-listed options would also, however, shape local economic geography more directly.

⁵⁴ Other impacts includes gains from tax from the move to more productive jobs and additional business output benefits

- 7.33** In particular, significant additional employment in the local area would be generated by all three short-listed schemes. This would include direct jobs based at the airport itself, but also additional indirect and induced jobs generated by the airport supply chain and the spending of its workers.⁵⁵
- 7.34** Heathrow, due to its high passenger forecast and concentration of labour-intensive transfer operation, is predicted to generate large numbers of jobs in both expansion options considered. For the Northwest Runway scheme up to 78,000 jobs, by 2050 would be generated by expansion. The Extended Northern Runway scheme would lead to a similar but slightly lower level of employment growth due to a lower forecast of passengers.
- 7.35** These employment opportunities would be of significant value to London's growing population. Several local authority areas around Heathrow also see relative high levels of unemployment, suggesting that any new jobs generated as a result of expansion would provide a welcome boost to overall employment in the area.
- 7.36** The numbers of jobs predicted as a result of expansion at Gatwick are lower, although still significant, and take longer to build up. This reflects both Gatwick's different business model, which has a higher proportion of low-cost carriers and less transfer traffic, and hence requires a smaller number of staff per passenger, and also the slower rate at which demand increases at the airport following expansion.
- 7.37** These employment impacts would be felt in an area of comparatively low unemployment, although they would be of material benefit to Crawley, which supplies the largest single proportion of the airport's workforce and has higher unemployment than the surrounding region, and to other areas with transport links to the airport such as Croydon.
- 7.38** The Commission's assessments of employment growth associated with each expansion option are set out in **Figure 7.4** below.⁵⁶

55 The pilot of a new flight enabled by airport expansion is working in a direct job; the delivery driver for the expanded catering company that supplies the food to the new flight is in an indirect job; and the barista in the coffee shop that opens to cater for the increased numbers of people around the airport is in an induced job. These jobs are likely to be additional in the local area, but not necessarily additional at national level as they may be generated by activity displaced from another area of the country.

56 The methodology used to generate these figures assumes a background improvement in productivity which reduces the number of jobs needed to service the same number of passengers by 1.5% per annum. This is why numbers decrease in some cases between 2030 and 2050, further details of this analysis is available in *Local Economy: Impact Assessment Post Consultation Updates*.

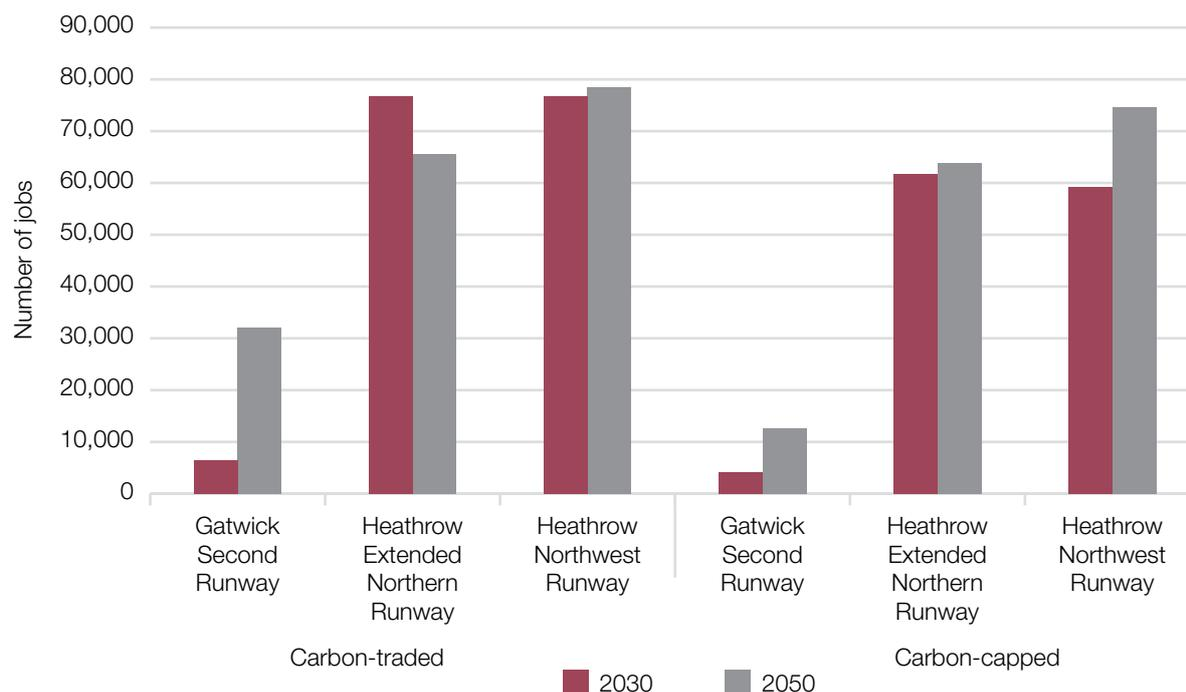
Figure 7.4: Local jobs created by expansion, assessment of need, up to 2030 and 2050

Source: Airports Commission analysis

7.39 Alongside assessing the impacts of expansion on employment, the Commission also evaluated the potential effects on housing demand, together with any knock-on impacts on social infrastructure such as schools and medical facilities. In response to consultation, this issue was investigated further, as a number of submissions argued that the associated challenges had been underestimated. This additional work included a fuller review of the extent to which this extra demand for housing and workers could be accommodated within the local area and wider surrounding region.

7.40 For the Heathrow schemes, the expansion takes place in a rapidly growing region and a local area with comparatively high rates of unemployment (8.5%⁵⁷ across the 5 local authorities closest to the airport); therefore it is expected that any additional pressure would be limited. The economically active population in the five local authority⁵⁸ areas closest to the airport is forecast to grow by 100,000 over the period to 2030 and in a wider group of 14 local authorities in the surrounding region by 160,000, more than twice the number of new jobs forecast to be generated by expansion. So a high proportion of new jobs may be expected to be taken up by people already living in the area and the additional capacity is not expected to result in an insurmountable requirement for additional housing.

⁵⁷ Based upon Nomis Annual Population Survey figures (Mar-Apr 2014)

⁵⁸ Spelthorne, Slough, Hounslow, Hillingdon and Ealing

- 7.41** The expanded airport would also benefit from improved surface access links including Crossrail, the western rail link to Reading and a new southern access link to Waterloo. These would make the employment opportunities associated with expansion much more attractive to a wider catchment, including the major Opportunity Areas in East London. The majority of these enhancements are not dependent on expansion, but the Southern Rail Access link would provide wider benefits for local communities which would not arise otherwise.
- 7.42** As expansion at Gatwick is expected to generate significantly fewer jobs than either of the Heathrow schemes, it would create less additional demand for housing and social infrastructure. It could still present challenges for the local area, however, given its rural nature and the comparatively low levels of unemployment in the majority of nearby local authority areas. As a result, any new employees might be drawn from locations further afield such as Croydon, where unemployment is higher and which would be highly accessible via the improved rail links serving the airport, thus reducing the degree of change. Given the very limited extent of the surface access improvements directly associated with expansion, however, it is unlikely that these would deliver any material additional benefits to the wider local economy or communities.
- 7.43** Expansion is also likely to generate new ‘catalytic’ jobs, in response to the increased levels of wider economic activity. These will occur across the country and are likely to be a significant and additional impact.⁵⁹ Further details of this analysis are available in the report *Strategic Fit: GDP/GVA Impacts*.

Weighing up the costs and benefits of expansion

- 7.44** The *Business Case* which accompanies this document includes an assessment of the overall Economic Case for the Commission’s recommended scheme and the other short-listed options. This section summarises the headline impacts and factors that underpin those assessments drawing from elements across the appraisal.
- 7.45** The benefits to passengers and users and the wider economy are significant across all three schemes and even allowing for the disbenefits from noise, air quality, and carbon, all produce substantial net benefits both in the carbon-traded analysis and with the carbon-capped case. However, there are differences in the type and scale

⁵⁹ Catalytic jobs are those created through wider business decisions driven by expansion. For example, a software engineer working for a company which has opened a new UK office because there is now a direct link to the US headquarters would be working in a catalytic job.

of benefits and disbenefits delivered. **Table 7.1** sets out the net present value of the monetised impacts and a qualitative assessment of the non-monetised impacts ranging from strongly negative (dark red) to strongly positive (dark green). The most significant disbenefit is the producer surplus, which as described earlier, is likely to be an overestimate as it does not take account of the productivity gains to airlines and their supply chains potentially driven by improved efficiency from higher levels of competition. Therefore the net benefits are potentially an underestimate.

Table 7.1: Net present value and social benefit calculation, *assessment of need*, £ billion, 2014 prices⁶⁰

Appraisal results	Gatwick Second Runway		Heathrow Extended Northern Runway		Heathrow Northwest Runway	
	CT	CC	CT	CC	CT	CC
Consumer surplus (includes removal of scarcity rents and frequency benefits)	47.1	27.2	46.5	29.1	54.8	33.6
Producer surplus	-41.8	-24.7	-31.6	-21.9	-38.4	-25.8
Government revenue	2.5	1.0	1.5	1.3	1.8	1.9
Delays	2.4	2.6	0.8	2.4	1.0	3.0
Wider economic impacts	8.1	5.5	10.0	6.6	11.5	7.7
Noise	-0.4	-0.4	-1.4	-1.1	-1.0	-1.5
Air quality	-0.2	-0.1	-0.6	-0.6	-0.8	-0.8
Carbon emissions	-1.0	-0.6	-0.8	-0.6	-0.9	-0.7
Biodiversity	0.0	0.0	0.0	0.0	0.0	0.0
Total benefits	60.1	36.3	58.7	39.3	69.1	46.2
Total dis-benefits	-43.3	-25.8	-34.4	-24.3	-41.1	-28.8
Net social benefit	16.8	10.5	24.4	15.1	28.0	17.4
Scheme and surface access cost (includes capex and all SA costs)	-6.0	-5.0	-14.1	-14.0	-16.1	-16.0
NPV (net social benefits and PVC)	10.8	5.5	10.2	1.0	11.8	1.4

60 Since consultation the Commission remodelled Heathrow Extended Northern Runway's noise impacts using the flightpaths generated for the Heathrow Northwest Runway option. The monetised disbenefits from this approach have been calculated on the basis of the Commission's carbon-traded forecast but not its carbon-capped forecast, and these numbers have been used in both net benefit calculations. The monetised values for biodiversity impacts are explored in further detail in the *Business Case* and *Biodiversity: Ecosystem Services* report. They comprise of values less than £50 million and so appear as zero in this table.

Appraisal results	Gatwick Second Runway		Heathrow Extended Northern Runway		Heathrow Northwest Runway	
	CT	CC	CT	CC	CT	CC
Non-monetised						
Surface access	Light green	Light green	Light green	Light green	Light green	Light green
Quality of life	Neutral	Neutral	Neutral	Neutral	Neutral	Neutral
Community	Light red	Light red	Light red	Light red	Light red	Light red
Place	Light red	Light red	Light red	Light red	Light red	Light red
Local economy	Light green	Light green	Dark green	Dark green	Dark green	Dark green
Water and flood risk	Light red	Light red	Light red	Light red	Light red	Light red

Source: Airports Commission analysis

7.46 The overall scale of net social benefits delivered by each scheme is most relevant to the consideration of whether a National Policy Statement or Hybrid Bill should be passed through parliament, given that a large proportion of the cost will be funded privately rather than by the public purse. Because the schemes are assumed to be predominantly privately funded, benefits to international-to-international transfer passengers are included, as they would contribute to the costs of the scheme as well as supporting the delivery of a dense route network for UK travellers. In addition, a calculation including scheme costs has been carried out to provide a net present value, given the scope for some or all of these costs to displace expenditure elsewhere in the economy.

7.47 This contrasts with publicly-funded projects for which a benefit-cost ratio is more relevant to allow government to prioritise public expenditure based on the comparative value for money of different projects. In this instance, however, even those elements which might be more likely to be publicly funded, in part or in whole, such as surface access interventions, would need to be judged on the basis of a broader benefit-cost ratio calculation which incorporates broader benefits to non-airport users.

- 7.48** The net social benefit is greatest under the Heathrow options, with the Northwest Runway scheme delivering the strongest results at £28.0 billion using the carbon-traded forecast and £17.4 billion with emissions constrained in line with the CCC's planning assumption. This is roughly 15% higher than the benefits from the Extended Northern Runway proposal and 66% higher than the benefits from a second runway at Gatwick.
- 7.49** When the lower costs of the Gatwick and Heathrow Extended Northern Runway options are taken into account these differences either shrink significantly or, in the case of the Gatwick scheme with carbon emissions constrained to 37.5MtCO₂, are reversed. This is also seen in some of the global scenarios considered. Gatwick's advantage in these cases would need to be offset, however, against the Heathrow schemes' stronger performance in respect of local economic impacts and stronger benefits for the airfreight sector.

Conclusion

- 7.50** Against the objective of **maximising economic benefits and supporting the competitiveness of the UK economy** the Heathrow Airport Northwest Runway option performs most strongly, generating £69.1 billion of benefits, compared to £58.7 billion from the Extended Northern Runway scheme and £60.1 billion from the Gatwick Second Runway. There are circumstances seen in the *low cost is king* scenario in which the direct economic benefits of expansion at Gatwick could outperform the Heathrow options, but this would require it to develop transfer traffic on a material scale and see a significant expansion in long-haul services. Furthermore, the £43.0 billion of passenger and delay benefits that Gatwick generates in this unlikely scenario although bigger are still of a similar order of magnitude to the Heathrow Northwest Runway's £42.3 billion, whereas the opposite is not the case when including the wider economic impacts and in many of the alternative views of the future including the *assessment of need*.
- 7.51** In terms of **generating employment and economic growth in the local area and surrounding region** the more labour-intensive nature of the long-haul and transfer dominated Heathrow means that expansion here would increase employment more rapidly and generate higher overall numbers of new jobs (almost double the number from expansion at Gatwick in 2050). These jobs would also be created in an area of higher unemployment than around Gatwick. Between the two schemes at Heathrow, the greater capacity of the Northwest Runway scheme means it has a slight advantage in generating employment over the Extended Northern Runway scheme.

- 7.52** On the Commission's objective of **producing positive outcomes for local communities and the local economy from any surface access that may be required to support the proposal**, the key difference between the schemes is the potential benefits for local communities and commuters from the Southern Rail Access link and the road widening interventions associated with the Heathrow schemes.
- 7.53** Finally to the extent that all schemes are privately financeable they can be seen **to make efficient use of public funds, where they are required** and in the case of each of the schemes **the benefits clearly outweigh the costs, taking account of social, environmental and economic costs and benefits**. In particular when the net social benefits of the schemes are calculated by offsetting economic benefits against environmental and social disbenefits all schemes perform strongly with the Heathrow Northwest Runway providing the greatest net benefits. In addition, when the scheme costs are included and netted off against the benefits, the Northwest Runway scheme also delivers the greatest benefits in the carbon-traded case. When scheme costs are included in the carbon-capped case the Gatwick Second Runway scheme performs better. However, these calculations do not include estimates for the foreign direct investment, tourism or broader benefits of associated additional surface access, which the Commission's analysis of strategic fit and surface access suggests may be of greater benefit at the Northwest Runway scheme.
- 7.54** Overall, Heathrow Airport Northwest Runway scheme performs most strongly in respect of its economic benefits. There are greater direct benefits for passengers and its wider economic impacts, such as on trade and agglomeration, are stronger. The Northwest Runway scheme would also deliver more local employment, providing a large number of jobs in an area of comparatively high unemployment and a city experiencing rapid population growth. The Commission notes the stronger NPV performance of the Gatwick scheme when carbon emissions from aviation are limited to the CCC's planning constraint, but believes that this is outweighed by the stronger overall benefits delivered by the Heathrow scheme, particularly if it is privately financed.

8. Surface Access Assessment

Introduction

8.1 The *Appraisal Framework* set the following objectives in respect of Surface Access:

- **to maximise the number of passengers and workforce accessing the airport via sustainable modes of transport;**
- **to accommodate the needs of other users of transport networks, such as commuters, intercity travellers and freight; and**
- **to enable access to the airport from a wide catchment area.**

8.2 The intention was to determine whether the three short-listed schemes could balance the requirements of minimising their adverse environmental impacts, co-existing with wider demands on the national and local transport networks and acting as an accessible national amenity.

Methodology

8.3 The promoters submitted detailed surface access strategies as part of their updated scheme designs in May 2014.

8.4 For the Gatwick Airport Second Runway and Heathrow Airport Northwest Runway schemes, the promoters' surface access strategies were taken forward for appraisal, following an audit by the Commission's technical advisors to determine that they were realistic.

8.5 In the case of the Heathrow Airport Extended Northern Runway scheme, the Commission had already stated in its *Interim Report* that it would consider the "hub station" concept put forward by the promoter as a detachable "bolt on" that could be considered alongside either Heathrow runway option. The analysis is discussed in the text box later in this chapter. The core appraisal of this scheme was therefore conducted on the basis of a surface access strategy similar to that proposed by Heathrow Airport Ltd for the Northwest Runway scheme. For the most part, therefore, this chapter does not differentiate between the two Heathrow schemes, save where it is necessary to bring out specific points of difference.

- 8.6** In order to enable a comparison of the schemes' impacts against an appropriate do minimum scenario in which the Government has continued to invest in surface transport networks to meet the requirements of background demand growth, two 2030 baselines were constructed – a core and an extended baseline. The full detail behind the construction of these baselines is outlined in the report *Process Overview*, located in *Additional airport capacity: surface access analysis*, which was published as part of the national consultation in November 2014. In short, the core baseline comprises the current road and rail transport networks together with a number of future road and rail schemes which are already funded and committed; while the extended baseline contains an indicative package of additional investment which broadly reflects the level of ongoing intervention needed to accommodate background demand in the absence of any airport expansion.
- 8.7** The Commission then incorporated those elements of the surface access packages in the scheme promoters' submissions which went beyond those schemes included within the baselines. Where the initial results of the analysis showed that links would be above their maximum capacity even once the baselines and the further enhancements suggested by promoters were taken into account, further infrastructure interventions were incorporated to alleviate this overcrowding.
- 8.8** In addition, the Commission's consultants conducted a separate review of the case for a spur from HS2 into Heathrow. While this did not form part of the surface transport package advanced by any of the scheme promoters, the Commission considered that it was important to understand the implications of the proposition.
- 8.9** As a result of responses to the consultation, further dynamic network modelling of surface access networks was undertaken, both to validate the analysis originally published for consultation and to enable detailed air quality dispersion modelling. The Commission has also carried out a number of additional pieces of analysis, including work on the impacts on local roads of expanding air freight at each shortlisted scheme and on the potential for a passenger access charge to reduce the level of road traffic generated by expansion at Heathrow.

Surface access strategies

Gatwick

8.10 Gatwick's surface access proposition is summarised at **Figure 8.1** and includes relatively few schemes other than those which it has been assumed would be required to meet background demand growth.

Figure 8.1: Improved surface access to the Gatwick Airport Second Runway scheme

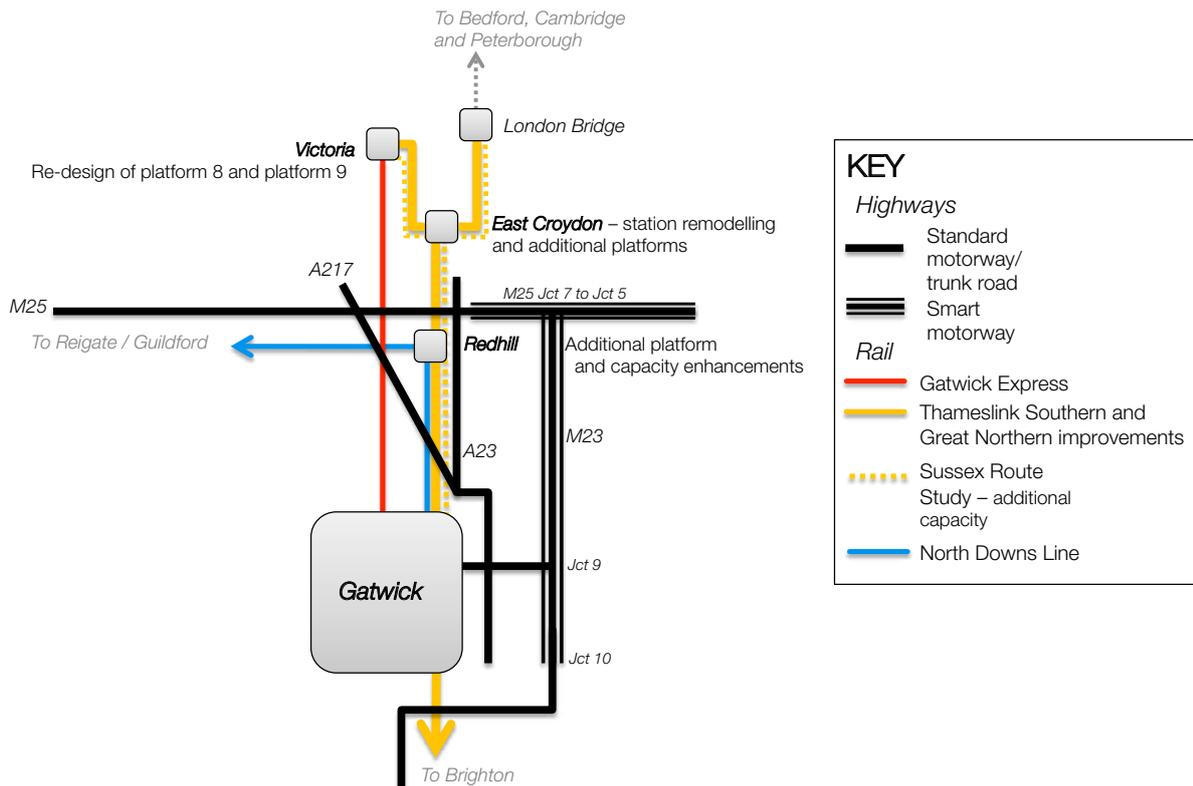

Source: Jacobs

8.11 In particular, the provision of acceptable surface access to an expanded Gatwick would be dependent on the current Thameslink programme, which is already committed, funded and under way, and will increase the airport's service frequency into Central London from 15 to 26 trains per peak hour, and a further package of enhancements to the Brighton Main Line, which could increase the peak time frequency to 32 trains per hour. The latter will be needed in addition during the 2020s to meet background demand growth and prevent severe overcrowding on peak-time services. The scope of this package is broadly understood, but it does not yet have funding or planning commitment.

8.12 These improvements will provide a significantly enhanced rail service, with a particular increase in the number of trains to London Bridge. The works which have been assessed as necessary specifically to support expansion are relatively modest, comprising of junction enhancements on the strategic road network as well as the rerouting of roads around the edge of the expanded airfield site. No rail schemes are required specifically to support expansion, beyond those needed to meet background demand growth. The schemes required specifically for expansion are summarised in the table below.

Table 8.1: Gatwick Second Runway related surface access enhancements

Category	Location	Requirement
Local road enhancement	M23 J9	Slip road widening
		Grade-separated flyover for southbound slip
	M23 J9 to J9a road widening	Widening of existing sections to four and five lanes as appropriate
	Airport Way	Widening of existing section to four lanes in each direction
	A23 re-alignment	Provision of new section of A23
		Grade-separated section of A23 re-alignment
	Long-term parking	New high capacity roundabout and approaches
	Industrial zone	New roundabout and approaches
	North Terminal access	New high capacity roundabout and approaches
		A23 to Airport Way grade-separated flyover
	New Terminal access	Provision of new section connecting M23 to new terminal
		Grade-separated section of new access to new terminal
	South Terminal access	New high capacity roundabout and approaches
	Longbridge Roundabout	Capacity enhancements
Gatwick Road	New roundabout and approaches	
Balcombe Road	Re-provision of existing road (standard 7.5m width one lane in either direction)	

Source: Airports Commission analysis

currently being carried out by Network Rail into the case and options for such a link. Because neither a firm proposal nor a funding package is in place, the Commission has taken the view that this should not be incorporated into the extended baseline and its costs should be treated as linked to the expansion of the airport.

The hub station concept

Alongside its proposal for an Extended Northern Runway, Heathrow Hub Ltd put forward the concept of a ‘hub station’ on the Great Western Main Line (GWML) to the north of the airport boundary. This would be located close to Iver and would be linked to the airport by a direct Automated People Mover (APM). The objective would be to provide enhanced rail access to the airport, with all services on the GWML stopping at the hub station, as well as to disperse road traffic to the airport, by providing an additional access point for passengers close to key strategic roads and motorways.

Figure 8.3: Hub station concept

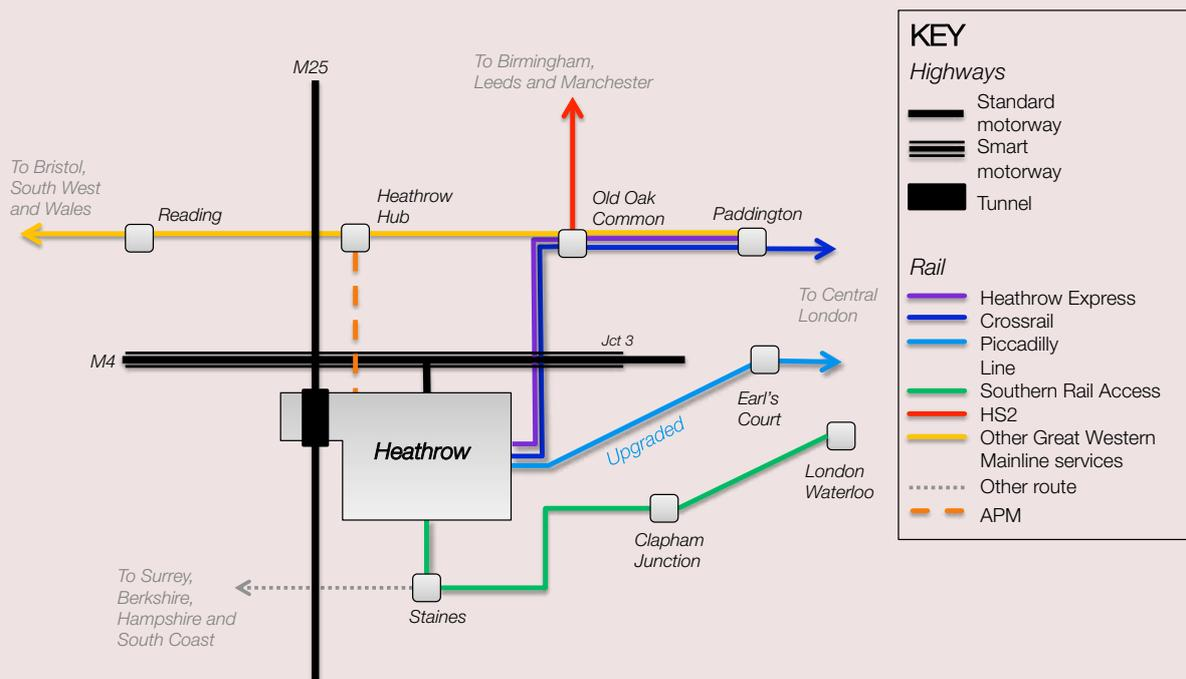

Source: Jacobs

As set out in **Chapter 5**, a separate appraisal of this concept was carried out by the Commission’s surface access consultants, Jacobs, and published for consultation. The analysis highlighted the following key features of the scheme.

It would reduce journey times to the airport for most passengers travelling to Heathrow from the West, South West and Wales, but there would be little or no difference for the larger proportion of passengers accessing the airport from London.

It would extend journey times for passengers using the GWML to travel to central London, rather than Heathrow, due to the imposition of an extra stop. These passengers far outnumber airport-bound passengers on this line.

It would be more expensive than the alternative Western Rail Access to Heathrow scheme, which provides access to the airport from the GWML via an interchange at Reading, with an estimated cost of £2.7 billion as opposed to £0.5 billion.

It could potentially produce air quality benefits by bringing traffic off the M4 and M25 before reaching Heathrow, although these benefits would be dependent on other factors, such as the scale of commercial development at the hub station site and whether the station itself served to attract GWML passengers who would otherwise have travelled to another station.

Responses to consultation were generally critical of the hub station concept, with a number of local authorities and other local stakeholders concerned that it would not align well with long-term local transport strategies and could act as a trip-generator in its own right, offsetting any potential reduction in congestion from airport traffic. In addition, Heathrow Hub Ltd's response was critical of several aspects of Jacobs' analysis. To address these concerns, an independent peer review of the Jacobs report was undertaken.

On the basis of the analysis published for consultation, the responses received on this issue and the subsequent review, the Commission has determined that despite the potential benefits it would bring to some passengers from the West of England and Wales, the costs and risks associated with the 'hub station' concept were such that it should not be recommended.

- 8.17** A number of road schemes were also included in the surface access strategy for the Heathrow Airport Northwest Runway scheme and are summarised in **Table 8.2** below. The core and extended baselines included a range of works to increase capacity on the key motorway links serving the airport, but even with these in place the traffic generated by expansion could lead to unacceptable levels of congestion. A number of additional widening schemes were identified, and included in the costs associated with the expansion proposals, although there may be potential for demand management measures to eliminate the need for some of them.

8.18 In addition, a range of works would be needed on the road network to accommodate the expanded airfield site including, for both schemes, the tunnelling of a section of the M25 to the west of the airport.

Table 8.2: Heathrow Northwest Runway related surface access enhancements

Category	Location	Requirement
Strategic road	M4 J3 to J4	Road widening
	M4 Airport Spur	Road widening
	M4 J2 to J3	Road widening
	M4 J4 and J4B	Road widening
	M4	Large M4 Junction 4b replacement
	M4	Higher capacity @ M4 J4a
	M4	Capacity improvements to existing main airport tunnel
	M25	M25 tunnelling costs (south of junction 15)
Local road network	A4	Diversion of A4 road alignment, dual carriageway
	A3044	Diversion of A3044 road alignment, dual carriageway
	Airport Roads	Airport Way/Southern Perimeter Road Interchange, grade-separated junction and flyover/bridge structures
	Heathrow Road Tunnel	Southern Road Tunnel/Southern Perimeter Road Interchange
	Airport One Way	One way system for western campus
Rail	Southern Rail Access to Staines	

Source: Airports Commission analysis

8.19 The road schemes required to support the Extended Northern Runway proposal are slightly more significant, due to larger impacts on M25 junctions. These are summarised in **Table 8.3**.

Table 8.3: Heathrow Extended Northern Runway related surface access enhancements

Category	Location	Requirement
Strategic road	M4 J3 to J4	Road widening
	M4 Airport Spur	Road widening
	M4 J2 to J3	Road widening
	M4 J4 and J4B	Road widening
	M4	Large M4 Junction 4b replacement
	M4	Higher capacity at M4 J4a
	M4	Capacity improvements to existing main airport tunnel
	M25	M25 tunnelling costs (south of junction 15)
Local road network	M25 J13 (A13) D2	Grade-separated junction and flyover/bridge structures
	Tunnel From A4 to T5	
	A4 Access	Tunnel running parallel to M25 – expected to have light traffic
	New roundabouts on access roads	Southern Road Tunnel/Southern Perimeter Road Interchange
	Airport Roads	New link from junction 13
	Heathrow Road Tunnel	Providing new spur access
	Airport One Way	Single lane widening
Rail	Southern Rail Access to Staines	

HS2 spur to Heathrow

In addition to the analysis described above, the Commission also assessed the case for a spur from the HS2 main line into Heathrow Airport, without the need for an interchange at Old Oak Common. The work carried out demonstrated that the scheme was likely to attract only a small number of passengers, carry a high capital cost and represent an inefficient use of HS2 capacity.

The Commission did not receive any persuasive arguments in favour of the HS2 spur as part of its national consultation. It is content, therefore, that such a spur should not form part of the surface access package that would accompany airport expansion and that there is not a robust business case for it at this time.

Assessment of the surface access proposals

Surface access capacity

- 8.20** A key theme to emerge from both the Commission's analysis and the responses to consultation is the extent of the challenge that arises as a result of background demand growth from commuters, intercity travellers and freight in London and the South East. Regardless of decisions on airport expansion, many key road and rail links in the region are expected to be close to capacity by 2030, even assuming the delivery of the Commission's extended baseline. Though all three schemes would have only a modest impact on congestion on most routes, the scale of the growth in background demand means that these impacts cannot be discounted.
- 8.21** By 2030, these issues are anticipated to be more severe on the links serving Heathrow, compared to those serving Gatwick (assuming that the interventions on the Brighton Main Line identified in the extended baseline, or alternative works of equivalent scale, are taken forward).
- 8.22** For Heathrow, the Southern Rail Access link and the central sections of Crossrail are forecast to be highly congested during the morning peak (on a par with the busiest sections of the London Underground network today and busier than current surface rail links), while the Piccadilly Line will also be reaching the limits of its capacity as it approaches central London.
- 8.23** On the strategic road network, a number of links near to the airport, particularly those sections of the M4 in the closest proximity, are expected to require widening to cope with increased demand resulting from expansion, although demand management measures, such as congestion charging, could be used as an alternative to this. Other lines such as the Heathrow Express and Western Rail Access are not expected to be so busy and, with the exception of some sections of Crossrail, the strategic road and rail links serving the airport will not be as congested outside peak hours.
- 8.24** Crowding levels for the Gatwick scheme are not expected to be as severe in 2030, although some services into London Bridge will be very heavily loaded during the morning peak. Even these, however, will not be as congested as the most crowded links assessed for the Heathrow schemes. Gatwick's advantage in terms of capacity is expected to diminish relatively quickly after 2030 as background and airport demand are both forecast to continue to grow strongly past that point.

8.25 It is clear that with or without airport expansion, the Government will need to take decisive action to address long-term capacity issues arising from background demand growth. This may involve the provision of new infrastructure, demand management, or a combination of the two. The additional challenges presented by airport expansion are not a transformative factor that would significantly change the scale of these challenges. The slightly lower crowding levels on Gatwick's services by 2030 must be offset against the greater diversity of links serving Heathrow, which allows greater scope for demand balancing, such as that which might be achieved by removing or reducing the premium pricing element for the Heathrow Express.⁶¹ Both sites therefore bring their own capacity challenges, with Heathrow's greater average levels of congestion being offset by its more flexible offering.

Usage of sustainable transport modes

8.26 For the Gatwick scheme, the enhanced rail offering is expected to enable a significant shift in the airport's public transport mode share by 2030, shifting it from 44% today to around 54%, which would be similar to the levels achieved today by leading comparable European airports and far in excess of levels seen in the United States. Only a small number of major airports, such as Hong Kong, achieve higher levels today.

8.27 For the Heathrow schemes, the greatly enhanced rail offering in place in 2030 is forecast to result in a large shift towards public transport among the airport's passengers, with the public transport mode share rising from around 41% today to around 53% in 2030. In response to points raised in consultation, further analysis of the likely impact of demand management measures has been carried out, which has found that charging private cars and taxis for access to the Heathrow site could result in even larger mode-share shifts, with public transport mode share potentially reaching 60% or higher.

61 Further details on the potential impact of removing the premium fare element of dedicated airport express services is described in more detail in the *Surface Access Reports* published for consultation in November 2014 (4. *Surface Access: Heathrow Airport Northwest Runway* and 4. *Surface Access: Gatwick Airport Second Runway*).

Figure 8.4: Public transport mode share at each scheme

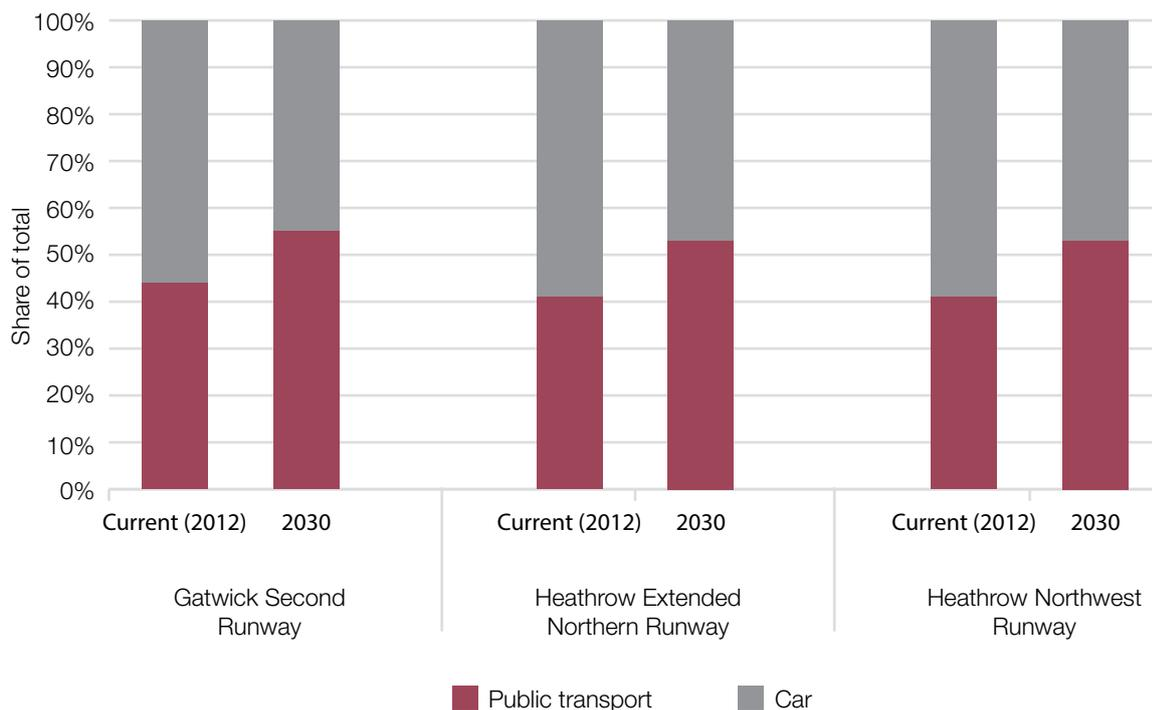

Source: Airports Commission analysis

8.28 While the Gatwick scheme achieves the slightly higher headline public transport mode share, Heathrow’s estimated share would, even without further demand management measures, represent a larger improvement on the present situation and a larger absolute number of passengers shifting to sustainable modes of transport.

The Airports’ catchment areas

8.29 For the Gatwick Second Runway scheme, the enhanced rail offering also drives an increase in the airport’s catchment population. There is an increase in the population within each of the airport’s isochrones (geographical travel-time bands), with the population within 30 minutes of the airport expected to rise from 530,000 today to 570,000 in 2030 and the population within three hours expected to rise from 25 million today to 34 million in 2030. In particular, the Thameslink programme drives an improvement in journey times from across London and from areas to the north and east of the capital including Hertfordshire, Cambridgeshire and East Anglia.

- 8.30** Similarly, for Heathrow, the enhanced rail offering expands the airport's catchment area. Crossrail and Southern Rail Access help the 30 minute catchment area population grow from 230,000 today to 700,000 by 2030, while the population within three hours of the airport is forecast to rise from 28 million today to 38 million in 2030. Crossrail and Southern Rail Access grow Heathrow's catchment area across London (particularly to the key business districts of the City of London and Canary Wharf), while HS2 greatly improves the airport's accessibility from the Midlands and the North.
- 8.31** The maps below in **Figures 8.5** and **8.6** show the expected distribution of demand for the airports and the associated journey times. From this it is possible to see the greater reach of both Heathrow schemes, particularly into the West Midlands and West of England, though the Gatwick scheme is able to serve the south coast with much shorter journey times.

Figure 8.5: Travel time to Gatwick Airport Second Runway in 2030

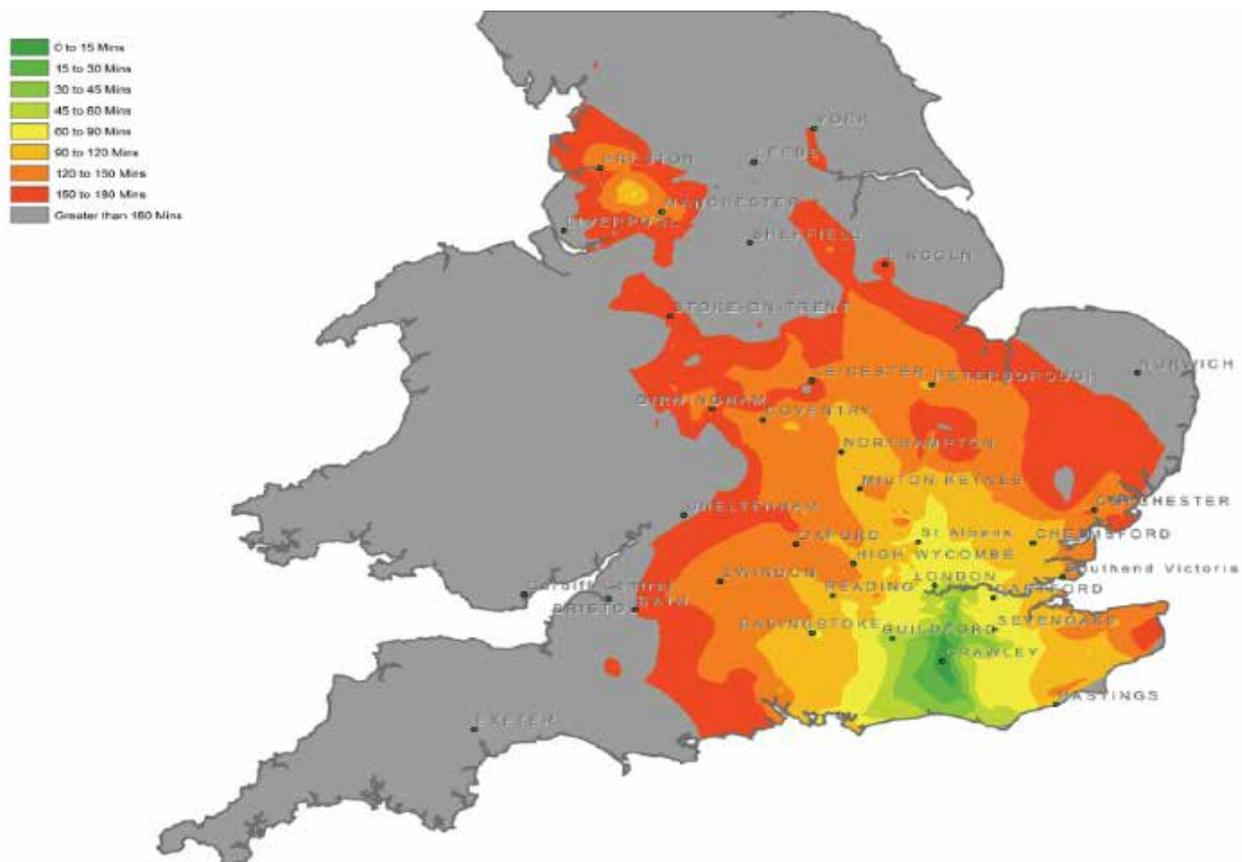

Source: Jacobs

Impacts on local roads

- 8.34** The impacts of the Heathrow Northwest Runway scheme and the Gatwick Second Runway scheme on the local road network appear to be relatively limited, except during periods of disruption. The reconfiguration of junctions on the M25 required by the Heathrow Extended Northern Runway scheme, however, produces some increased congestion on a number of local roads, chiefly in the Poyle and Colnbrook areas. The placement of the M25 into a tunnel would require careful management to reduce or eliminate adverse impacts during the construction phase.
- 8.35** In response to consultation feedback, further work was undertaken on the impacts of increased goods vehicle movements, stemming from an increase in air freight volumes, on road congestion. The analysis revealed little impact on overall levels of congestion, but highlighted specific roads, chiefly in the vicinity of Heathrow, which may experience a noticeable increase in goods vehicle movements.

Conclusion

- 8.36** Against the objective to **maximise the number of passengers and workforce accessing the airport via sustainable modes of transport**, all three schemes demonstrate broadly similar levels of performance. The Gatwick scheme achieves a slightly higher overall public transport mode share (54% vs 53%), but the Heathrow schemes demonstrate a larger increase in performance against current levels and a larger shift in the number of passengers switching to sustainable modes.
- 8.37** Against the objective to **accommodate the needs of other users of transport networks, such as commuters, intercity travellers and freight**, the Gatwick scheme would see more available capacity on key transport links serving the airport by 2030. However, this advantage reflects in part the slower growth in traffic at Gatwick under the Commission's forecasts and can reasonably be expected to diminish after 2030.
- 8.38** Against the objective to **enable access to the airport from a wide catchment area**, both schemes will have good connectivity across London within their inner isochrones. However, when the outer isochrones are taken into account, the Heathrow schemes can be seen to offer better access for passengers across the Midlands and North West, particularly due to HS2, while the Western Rail Access link will also provide a superior connection to the West of England and South Wales, enabling a wider spread of economic benefits.

- 8.39** Taken together, the results of the Commission’s surface access analysis have highlighted strengths and weaknesses of both the Heathrow and Gatwick sites. However, the Commission’s view is that, when all factors are taken into consideration, Heathrow’s surface access links mean that it is better placed to act as a nationally accessible amenity. Gatwick’s surface access package represents a significant improvement on the situation today, but remains more suited to serving the London and South East region rather than the wider UK. Combined with the more significant risks arising from serious disruption to surface access links, the Commission’s view is that Heathrow’s performance against the surface access objectives is marginally stronger than Gatwick’s.
- 8.40** While the performance of the two Heathrow schemes is similar in most respects, the different road configurations required to accommodate the expanded airfield site have been demonstrated to produce fewer adverse consequences in the case of the Heathrow Airport Northwest Runway Scheme.

9. Environment Assessment

Introduction

9.1 The environmental impacts of aviation are significant. Aviation noise is disturbing to local communities and can have consequences for health and for educational performance. The pollutants associated with airport operations and their surface transport links also have health impacts and growth in aviation generates additional emissions of carbon dioxide, contributing to climate change. Proposals for airport expansion may present risks for nearby habitats, including any protected sites, and water resources, as well as leading to housing loss and impacts on local landscapes and townscapes.

9.2 The *Appraisal Framework* incorporated a number of objectives relating to the environmental impacts of the shortlisted schemes, reflecting the significant importance the Commission attached to them. They are set out below:

- **to minimise and where possible reduce noise impacts;**
- **to improve air quality consistent with EU standards and local planning policy requirements;**
- **to protect and maintain natural habitats and biodiversity;**
- **to minimise carbon emissions in airport construction and operation;**
- **to protect the quality of surface and ground waters, use water resources efficiently and minimise flood risk; and**
- **to minimise impacts on existing landscape character and heritage assets.**

9.3 The performance of the shortlisted schemes against each of these objectives was assessed through a separate appraisal module, covering noise, air quality, biodiversity, carbon, water and flood risk and place. This chapter considers each of them in turn.

9.4 In their visits to the local communities close to the shortlisted airports, as well as in meetings and discussions with community members and their representatives, the members of the Commission have been repeatedly reminded of the significant importance attached to these factors, and the very real concerns of local people in relation to both the current impacts of the airports and the potential changes that might occur as a result of expansion. These concerns were also strongly voiced in the public discussion sessions and have been a theme of many consultation responses. Ensuring that a detailed and rigorous analysis of these impacts has been undertaken has therefore been a critical priority throughout the process.

Noise

9.5 In July 2013, the Commission sought responses to a detailed paper on this issue, *Discussion Paper 05: Aviation Noise*, which covered a range of topics including the measurement of noise impacts, their implications for health and well-being and how they may be mitigated. The responses to that paper informed the Commission’s approach to aviation noise in its *Appraisal Framework* and detailed analysis of the noise impacts of each scheme was provided at consultation. Since then, further sensitivity analysis has been undertaken and an additional review of the health impacts of noise has been carried out.

9.6 In general terms, the impact of aircraft noise is a function of the number of planes flying overhead, the technologies being used within those aircraft and the paths the aircraft take when approaching the airport. Also important are measures used on the ground to limit the effects on people. There is a clear trend over recent decades of reductions in aviation noise due to technological and operational improvements, which is predicted to continue and has been incorporated into the Commission’s assessments. This trend can be seen in the **Figure 9.1** below.

Figure 9.1: Historic and future trends in cumulative certificated aircraft noise levels from noise discussion paper, 1960-2040

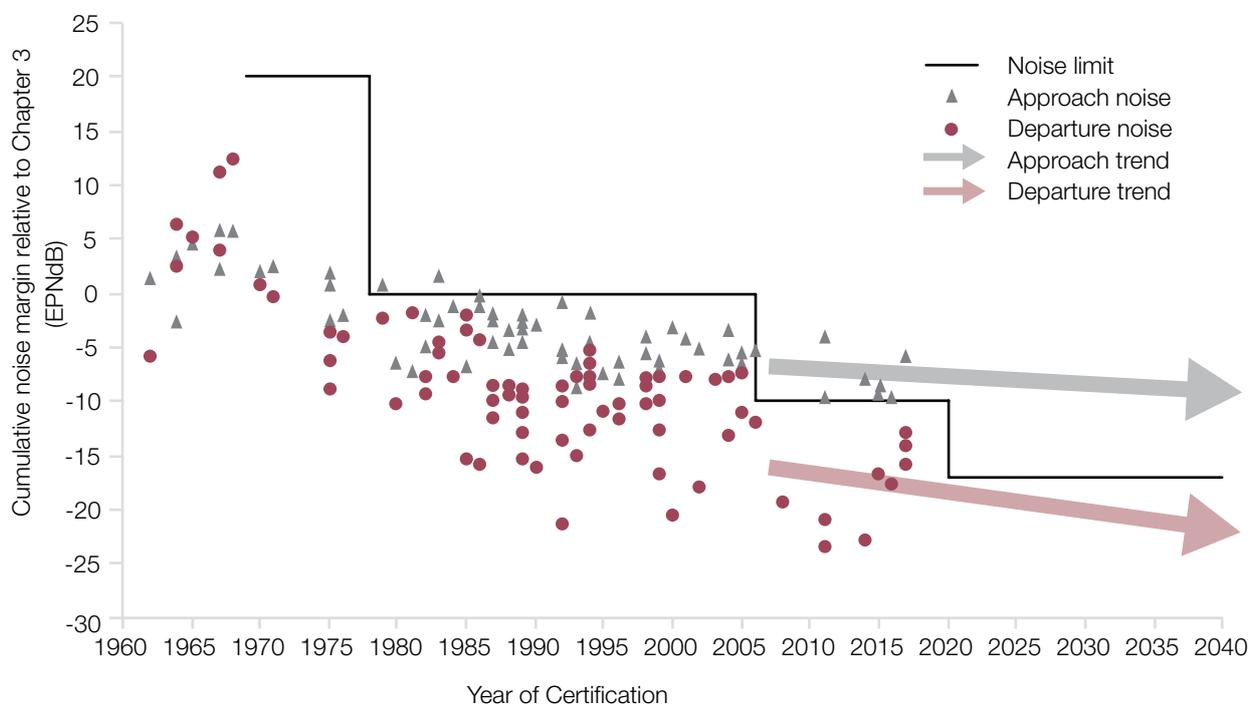

9.7 Despite these improvements, increasing air traffic has meant that aviation noise remains a source of considerable concern to communities close to airports. This is as a result both of its impacts on health and educational performance and of its broader consequences for people's day-to-day lives. Aviation noise is therefore a central issue in assessing the impacts of any proposal for expansion. It is also important to consider the most effective approaches to mitigating or compensating for noise impacts, to ensure that they are managed and reduced wherever possible.

Methodology

9.8 The Commission's approach to assessing aviation noise impacts was developed in the light of responses to its discussion paper on aviation noise which indicated that focusing solely on any single metric would be unlikely to provide a rounded view of the potential impacts of any proposal for expansion.

9.9 The Commission therefore developed a 'noise scorecard', which includes a range of methods for appraising noise impacts, including conventional metrics which assess noise levels over a period of time, covering day (7:00am – 11:00pm), night (11:00pm – 7:00am) and the full 24 hour period. The latter metric places additional weight on noise impacts in the evening and at night. Recognising community concerns, however, that it is not only the noise level which is important but also the number of flights that are experienced, they also include more innovative 'number above' metrics, which assess the number of times a location is overflowed by aircraft whose noise impacts exceed a specified level.

9.10 The full range of metrics included in the noise scorecard is:

- day noise (L_{Aeq16h} 7:00am-11:00pm) and night noise (L_{Aeq8h} 11:00pm-7:00am), looking not only at the 57 decibel level used by the government as its key metric, but also down to the lower 54 decibel level during the day and the 48 decibel level at night, and up to 72 decibels in both cases;
- the European 24 hour L_{den} measure, which puts more weight on noise that occurs in the evening or the night than the daytime, covering the 55 decibel level used by the European Commission to assess aviation noise and additional levels up to 75 decibels; and
- N70 contours for the daytime, capturing the population affected during the day by overflights whose noise impacts exceed 70 decibels, and N60 contours for the nighttime.

- 9.11** To assess the shortlisted schemes' performance against each metric, the Commission developed noise contours showing the current situation, the future with no expansion (the do minimum case) and the future with expansion. For each of the future scenarios, contours were developed for 2030, 2040 and 2050. The detailed results against all of these metrics can be found in the technical document *Noise: Local Assessment*.
- 9.12** The analysis included assessments using the Commission's carbon-capped *assessment of need* forecast (for all schemes), which provided a lower-end estimate, and the carbon-traded *low-cost is king*⁶² and *global growth*⁶³ forecasts, for a higher-end estimate. This report focuses on the carbon-capped *assessment of need* results, as they are based on a consistent forecast across all three shortlisted schemes and are consistent with the Committee on Climate Change's planning assumption for aviation. The relative performance of the schemes, however, does not change significantly when using the higher-end noise outputs.
- 9.13** To inform the assessments, indicative flightpath designs for each scheme were developed by the CAA, drawing on inputs from NATS, the scheme promoters and the Airports Commission Secretariat. These indicative designs should not be taken as providing a reliable guide to where future flightpaths may in practice be located, but are sufficient to assess the potential noise impacts at this stage of scheme development. Creating and agreeing airspace plans requires a process of detailed design and public consultation and the careful consideration of options for mitigating any negative impacts.
- 9.14** In its response to consultation, Heathrow Hub Ltd challenged the indicative flightpaths used to assess the Extended Northern Runway scheme. In the light of these criticisms, new airspace designs were developed and assessed for its scheme, broadly in line with those developed for the Northwest Runway scheme to minimise the total population affected by the airport. These show substantially different results from the version published for consultation, demonstrating the potential to reduce impacts by changing flightpaths. The results can be found in the technical document *Noise: Local Assessment Addendum*, and are used as the basis for the assessment of the Extended Northern Runway scheme in this report.
- 9.15** These quantitative results alone cannot completely capture how noise is experienced by local communities. In particular, the Commission has heard from residents about the importance of predictable periods of the day without aircraft flying overhead. Known as respite, this cannot easily be captured in the contours

62 For the Gatwick Second Runway and Heathrow Northwest Runway schemes

63 For the Heathrow Extended Northern Runway scheme

described above as it alters the times when noise is experienced more than the average level experienced across a day or night. The Commission has therefore also qualitatively assessed the impacts of mitigations such as respite and restrictions on night flights (which are also not easily measured through average noise contours).

- 9.16** Many consultation respondents also raised the importance of considering the impact of expansion on areas of existing tranquility. An analysis of tranquility impacts was carried out as part of the Place appraisal module, and its results are discussed in the assessments below.

Assessment

- 9.17** There are very substantial differences in overall noise impacts between expansion at Heathrow and at Gatwick, whereas those between the two Heathrow schemes are more nuanced. So this assessment focuses first on the relative performance of the two airports, before considering how the Extended Northern Runway compares to the Northwest Runway scheme.

Comparing noise impacts at Heathrow and Gatwick

- 9.18** In assessing the relative noise impacts of Gatwick and Heathrow expansion, the Commission has focused on two key issues: the total number of people affected by each scheme and the scale of change in the population affected compared to a future baseline in which no expansion has taken place. The Commission has also considered the scale of change compared to the noise levels experienced at each location today to give a sense of how noise impacts may change over time.
- 9.19** Due to its relatively rural location and sparsely populated wider local area, expansion at Gatwick would affect considerably fewer people in total than either of the two Heathrow schemes. This pattern does not change substantively across the different metrics considered. Focusing on the 55 L_{den} metric, for example, as this covers the full 24 hour period, the Gatwick scheme would affect approximately 22,000 people in 2030, rising to almost 25,000 by 2050. In contrast, the two expansion proposals at Heathrow would affect more than 550,000 people in 2030, rising to between 570-640,000 by 2050. The differences in performance between the three schemes in 2050 can be seen in **Figures 9.2, 9.3, and 9.4**.

Figure 9.2: 55L_{den} contours for Gatwick Airport Second Runway, carbon-capped assessment of need, 2050

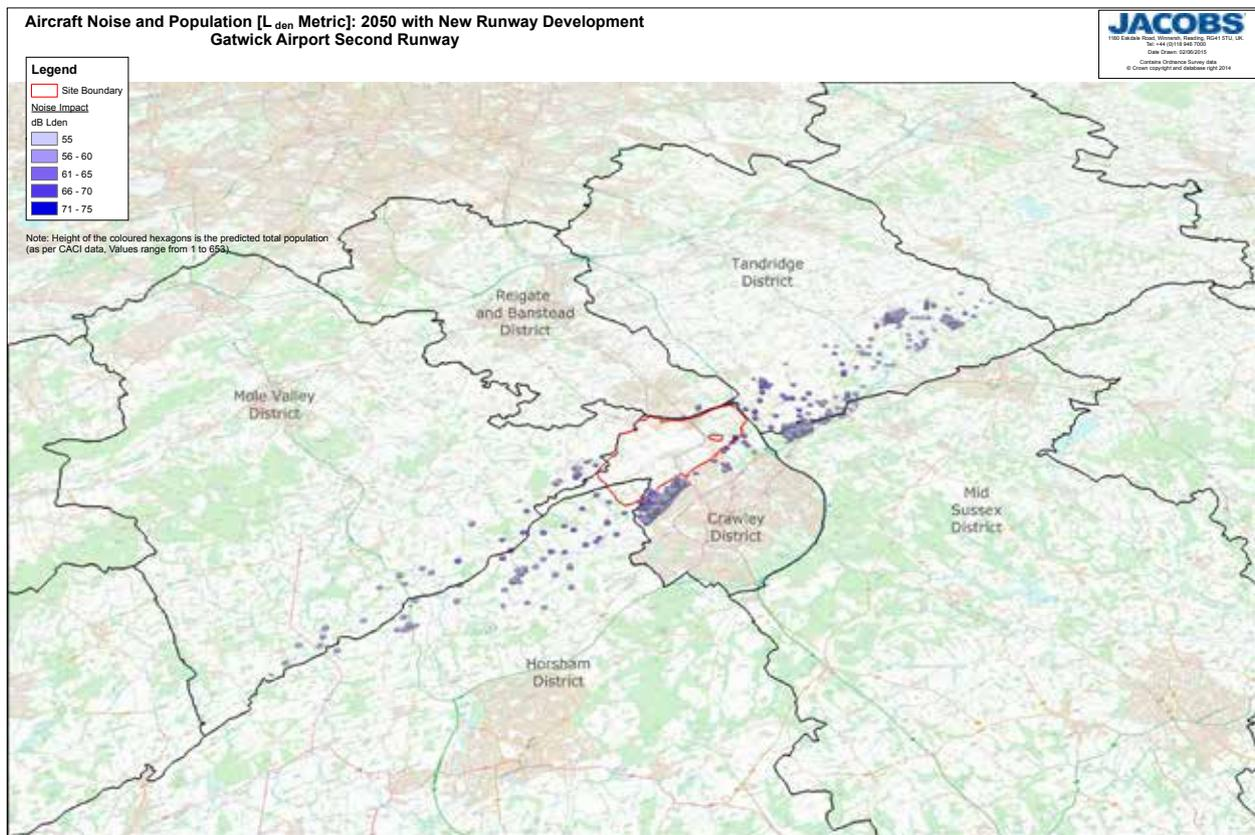
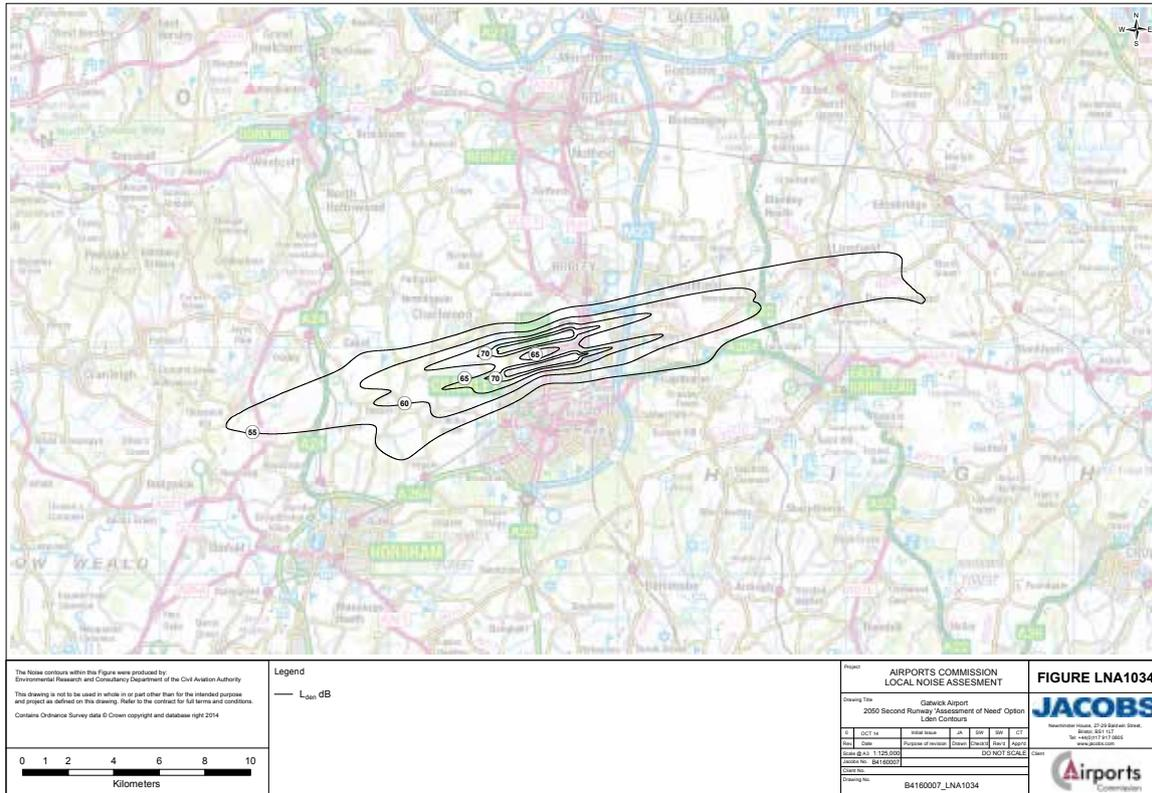

Source: CAA and Jacobs

Figure 9.3: 55L_{den} contours for Heathrow Airport Extended Northern Runway, minimise total carbon-capped, assessment of need, 2050

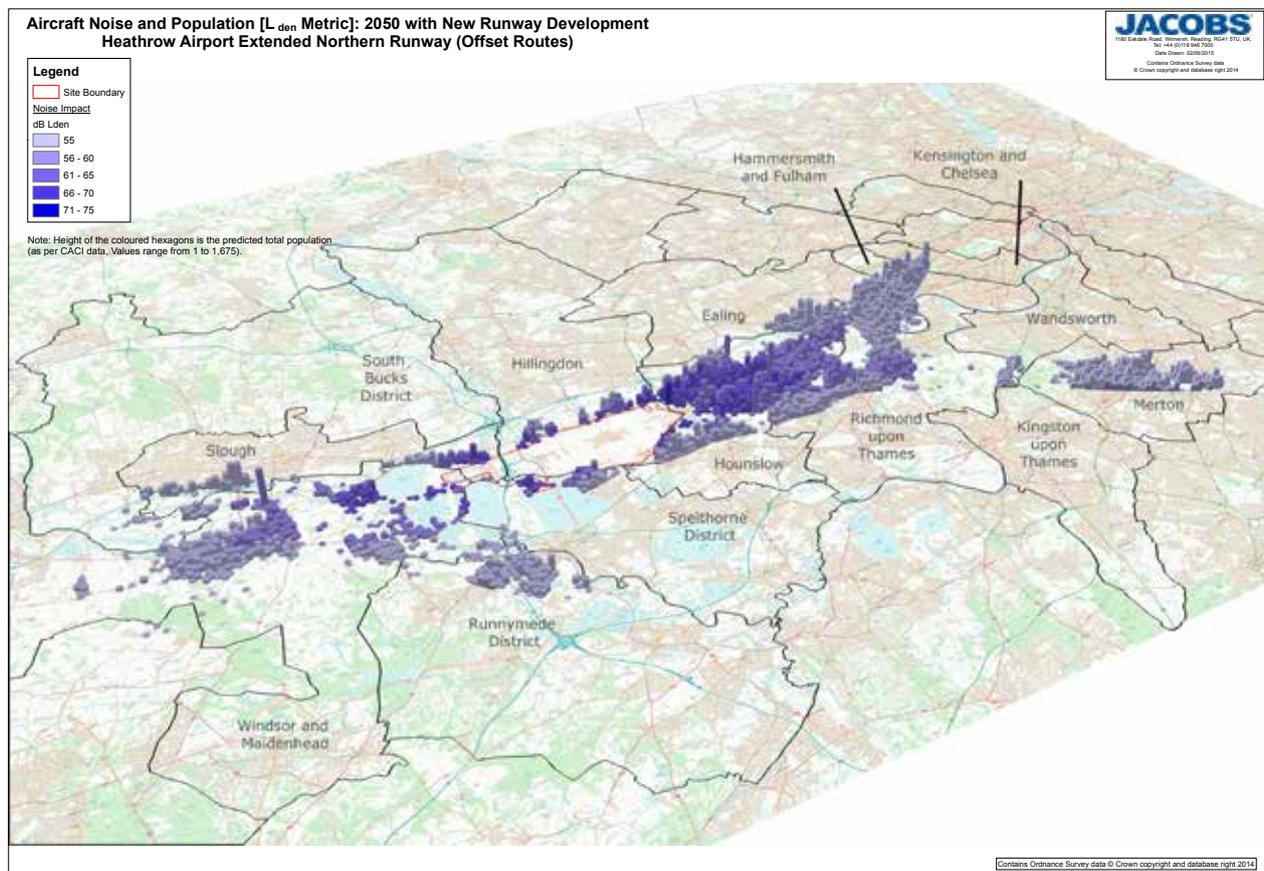
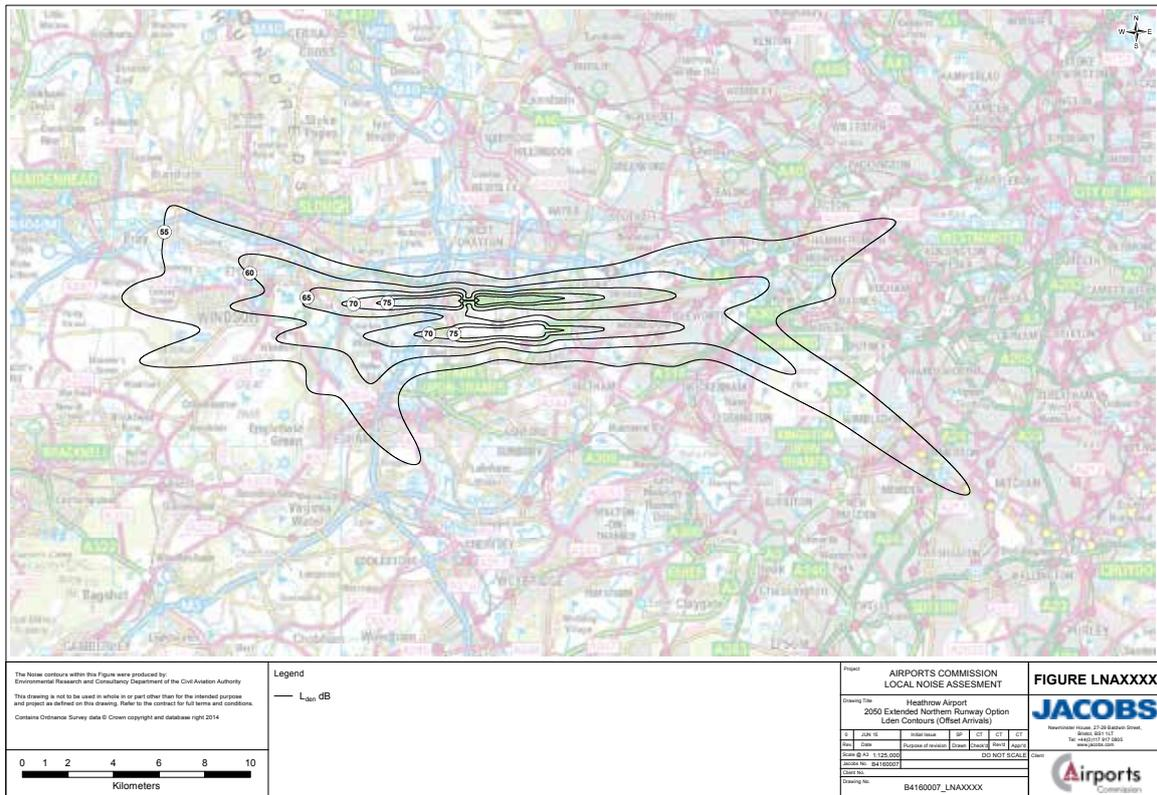

Source: CAA and Jacobs

Figure 9.4: 55L_{den} contours for Heathrow Airport Northwest Runway, carbon-capped, assessment of need, 2050

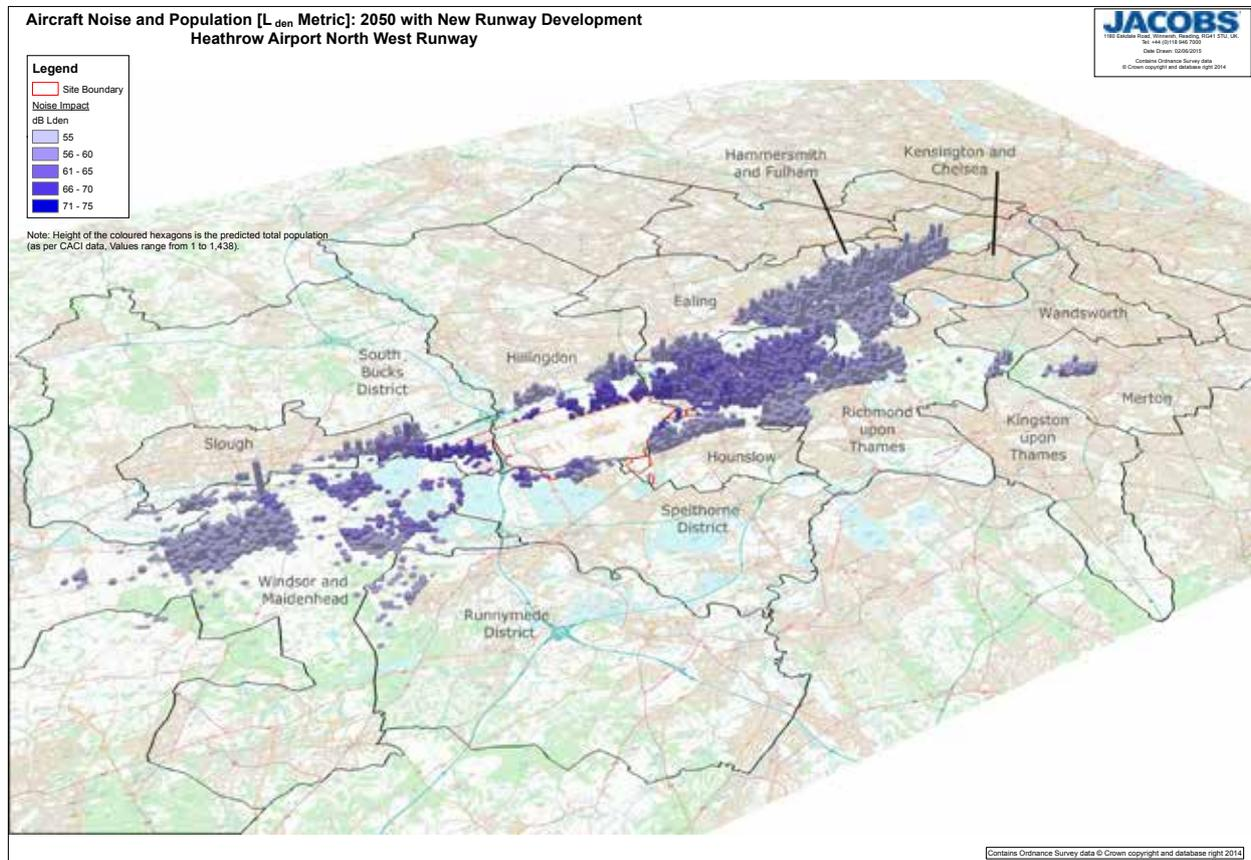
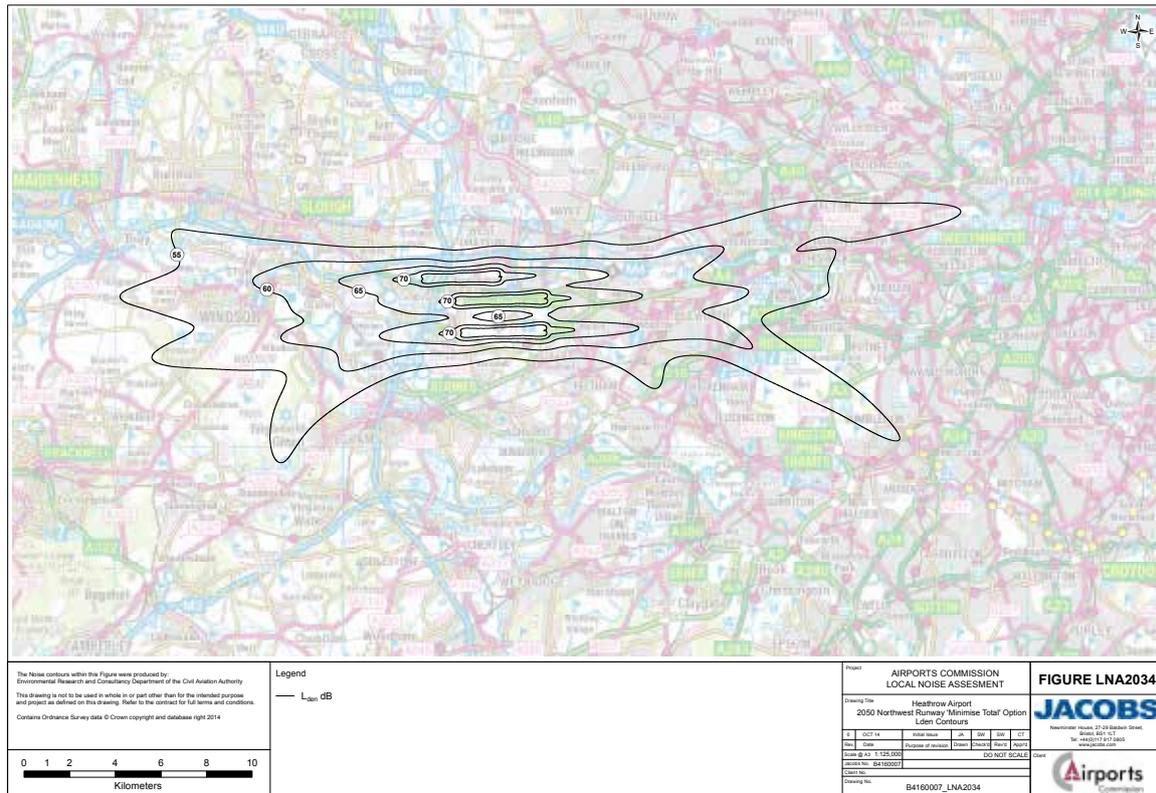

Source: CAA and Jacobs

- 9.20** In terms of relative performance against the do minimum case, the picture is more nuanced but overall Gatwick's impacts are less severe than those of Heathrow expansion.
- 9.21** The effects of expansion at Gatwick on daytime noise are greater than at Heathrow in percentage terms, but the aggregate numbers of additional people affected are much smaller across all metrics. For example, looking at the 57 decibel daytime contour, the two expansion schemes at Heathrow would see an increase in the population affected of 16-37,000 people in 2030 against the do minimum case, compared to fewer than 3,000 at Gatwick. The same pattern is seen in the number above contours, with the population experiencing more than 50 flights in a day whose noise impacts exceed 70 decibels rising by 12-28,000 people with expansion at Heathrow, as opposed to just 3,600 people with Gatwick expansion. The latter is approximately a trebling of the baseline level compared to an increase of less than 20% at Heathrow, but that does not outweigh the stronger performance of the Gatwick scheme in aggregate terms.
- 9.22** In terms of night noise, all three schemes could potentially deliver a reduction compared to the do minimum case in some instances. This effect is particularly strong at Heathrow for the largest 48 decibel nighttime contour, which reduces significantly in size due to the schemes' ability to disperse flights over a broader area and the heavy use in these periods of the new runway capacity, which for both schemes would be to the west of the existing runways and hence would keep flights at a greater altitude as they approach over London. The effect is more mixed, however, for the higher decibel noise contours and the number above nighttime contours, with some reductions and some increases in population for both schemes. The Gatwick proposal, in contrast, would increase the numbers of people captured in the largest nighttime contours, but would reduce them in most contours from 60 decibels upwards.
- 9.23** It is important to note that new flightpaths and other changes can both bring people into a noise contour and remove people from it. The changes compared to the do minimum described in the paragraphs above are the net change, which combines both of those effects. The number of people newly affected by noise is generally higher for the Heathrow schemes, but this is offset, and in some cases outweighed, by people who are taken out of a contour. It should also be remembered that noise contours provide a valuable means of measuring noise impacts, but do not mark the limits of where aviation noise may be experienced. In designing flightpaths for any new runway, it will therefore be important to take a broad view of how and where the effects of noise may be felt.

9.24 This analysis is summarised in the **Figures 9.5** and **9.6**:

Figure 9.5: Day noise impacts at the three short-listed options, carbon-capped, assessment of need, 2013 and 2030

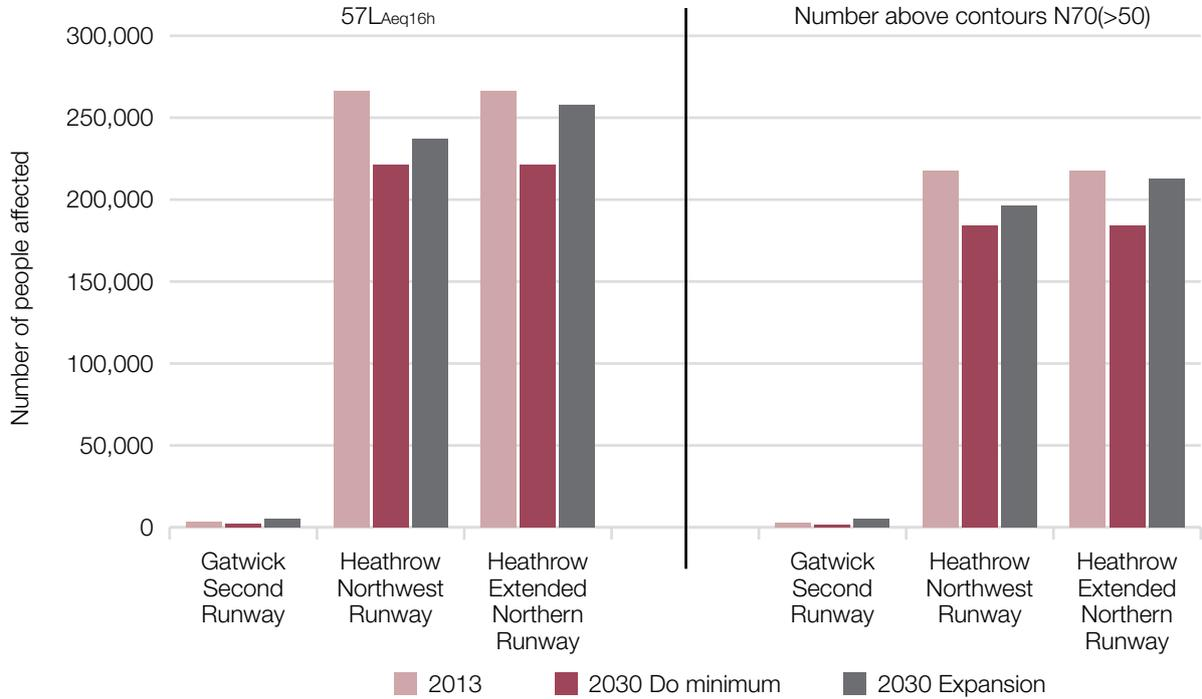

Source: Airports Commission analysis

Figure 9.6: Night noise impacts at the three short-listed options, carbon-capped, assessment of need, 2013 and 2030

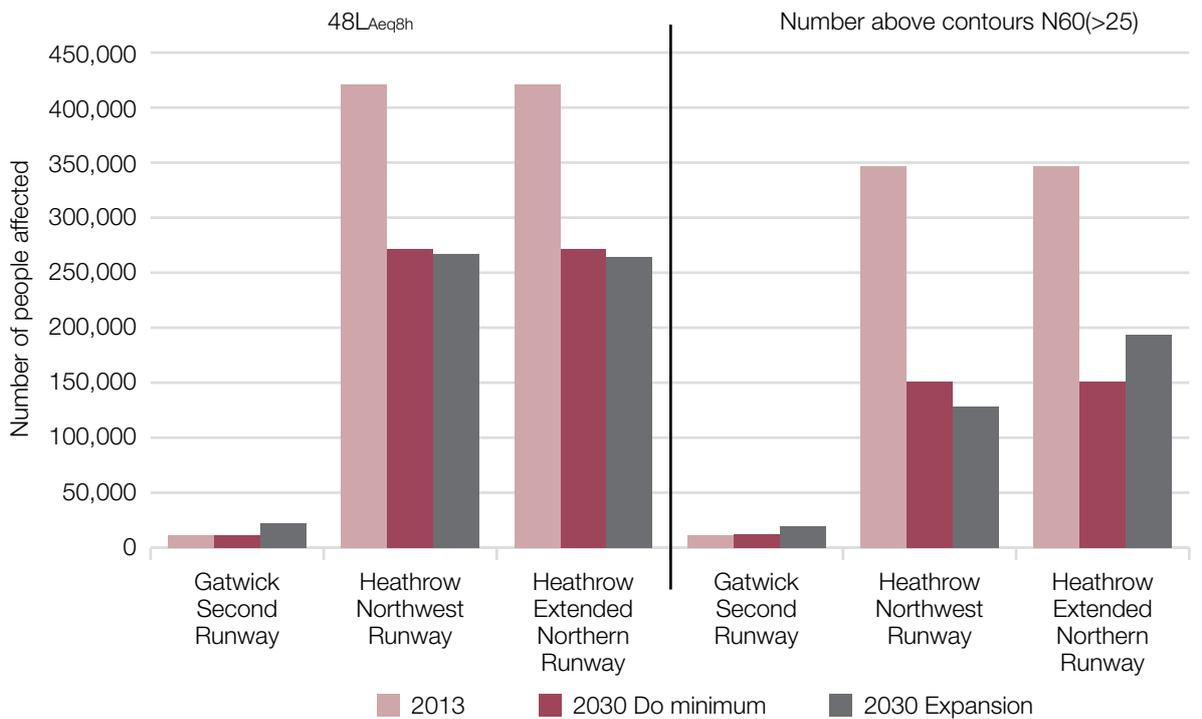

Source: Airports Commission analysis

- 9.25** The Commission's view is that the relative performance of the Gatwick Airport Second Runway scheme compared to the baseline is stronger than that of the Heathrow schemes, although the ability of the Heathrow schemes to reduce noise levels against some metrics, particularly in the nighttime period, is still of value. However, the percentage increase in population over the do minimum case resulting from expansion at Gatwick is higher than that of either Heathrow Airport scheme.
- 9.26** When focusing on performance against today, however, the Heathrow schemes clearly have the advantage as they generally deliver a reduction in noise impacts compared to current levels, whereas the Gatwick scheme sees noise impacts increase in almost every case. This reflects the fact that the improvements in noise impacts forecast to be delivered by new technology and improved operations at Gatwick are outweighed by the increases resulting from growth in flights and by the location of the new runway close to the northern edge of Crawley. In contrast, the additional capacity at Heathrow is smaller as a proportion of current capacity and the location of the new or extended runway would be more advantageous in respect of managing noise impacts, meaning that while the background noise reductions would be offset to some degree, they would not be eliminated.
- 9.27** The promoter of the Gatwick scheme proposes that both runways should be operated in mixed-mode at the expanded airport, preventing the provision of respite through runway alternation, as would be delivered under both Heathrow schemes to some degree.⁶⁴ The analysis carried out for the Commission's Place appraisal module indicates that the Gatwick scheme also performs less well than the Heathrow schemes in terms of its impacts on tranquility, reflecting the more rural nature of the surrounding area. This can be seen from the maps below using the Campaign to Protect Rural England's (CPRE) tranquility maps. Red colouring indicates areas that the CPRE considers less tranquil.

64 Though it would still be possible to vary flightpaths for respite purposes

Figure 9.7: Gatwick Airport Second Runway noise and tranquility map

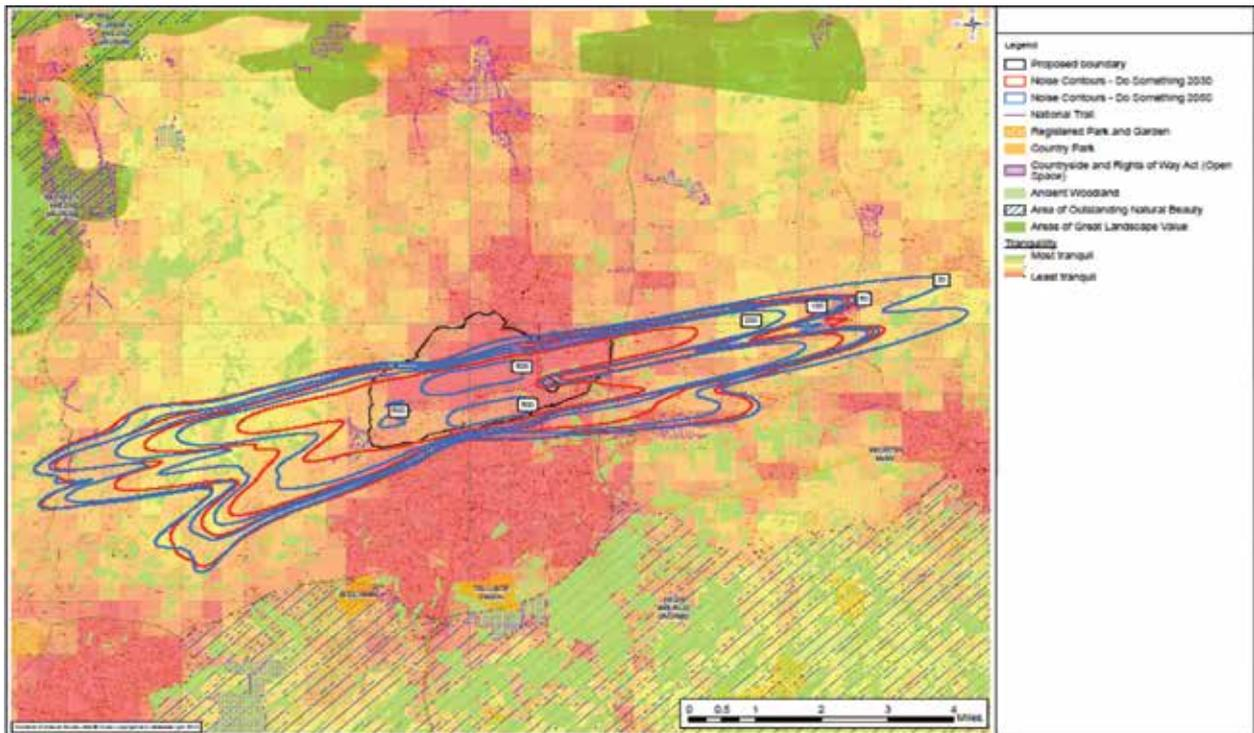

Source: CPRE & Jacobs

Figure 9.8: Heathrow Airport Extended Northern Runway noise and tranquility map

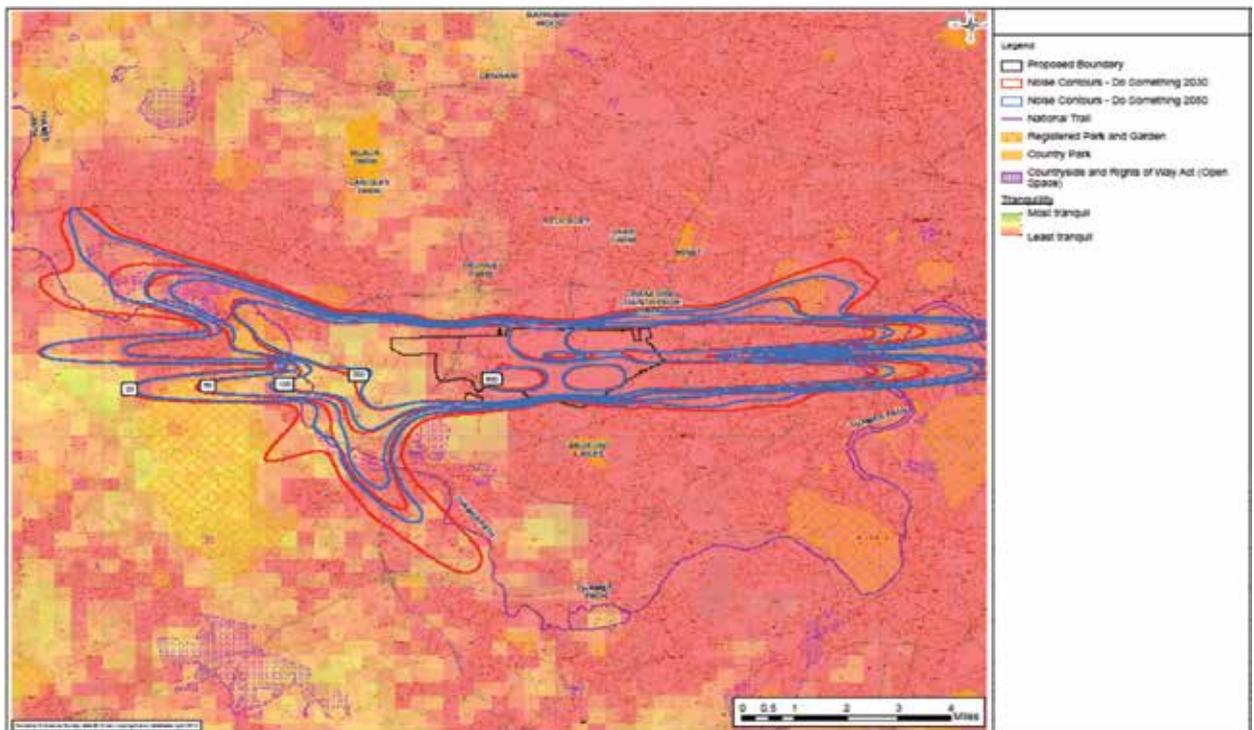

Source: CPRE & Jacobs

Figure 9.9: Heathrow Airport Northwest Runway noise and tranquility map

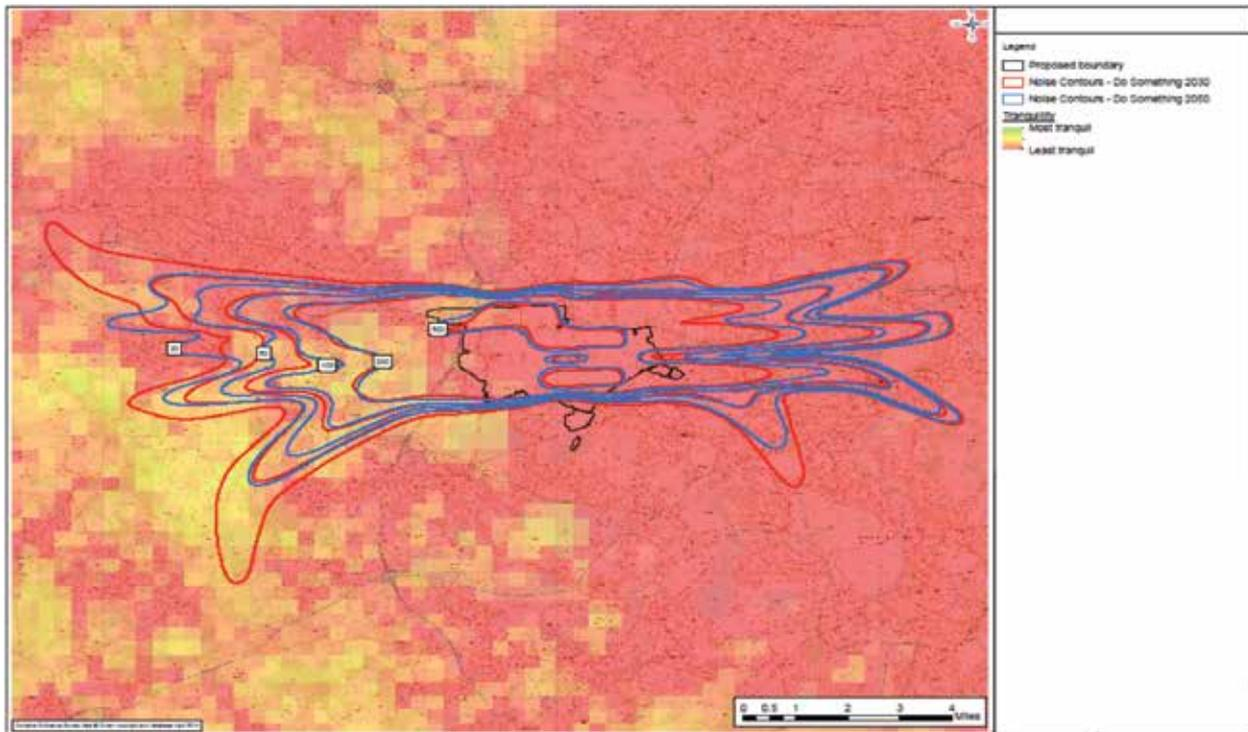

Source: CPRE & Jacobs

9.28 The Commission’s overall assessment is while Gatwick expansion generates a larger relative change in percentage terms and performs less strongly in terms of respite and tranquility, the far smaller aggregate numbers of people affected and the more limited changes compared to the baseline mean that the Gatwick scheme performs more strongly in terms of its noise impacts than the options for expansion at Heathrow.

Comparing noise impacts between the Heathrow Northwest Runway and the Extended Northern Runway

9.29 There are important differences between the two Heathrow schemes which need to be taken into account. They relate particularly to the provision of respite for local communities and the impacts on those nearest to the airport.

- 9.30** Respite from aviation noise can be achieved by alternating runways used for arrivals and departures, as well as through alternating between different local airspace designs on particular days or at particular times of the day. In respect of arriving flights, however, the latter is only relevant to communities more than 3-5 nautical miles from the airport boundary,⁶⁵ because once aircraft reach that point they join a fixed approach path to their landing runway. Therefore runway alternation respite is the only option for many of those living within the highest noise contours. At present, capacity constraints require Heathrow to sacrifice runway alternation on an almost daily basis, with the period between 6:00am and 7:00am being particularly vulnerable.
- 9.31** The Northwest Runway scheme has the greatest opportunity for respite from runway alteration throughout the day as arrivals and departures are able to cycle around the three different runways. The scheme's promoters have proposed an alternation scheme whereby one runway would be used for arrivals only, one for departures only and the third in mixed-mode (i.e. accommodating both arriving and departing services) at different times across the whole of the operating day. This could be delivered without impacting on assessed resilience or capacity.
- 9.32** In contrast, because neither section of the extended runway could be used in mixed-mode while the other is operating, the scope to deliver respite through runway alternation under the Extended Northern Runway scheme would be more limited. In particular, only a single mode of operation would be possible during the 6:30am-12:00pm and 4:00pm-7:00pm peak periods, which account for half the operating day. Outside these periods, the scheme promoter has proposed a number of alternative operating modes that could be used, but the overall level of respite delivered could be lower than the alternative Heathrow scheme. Once the airport's runways were full or reaching that point, any broader package of respite could only be delivered at the expense of total capacity or resilience, and even the respite provided outside peak hours would be at risk whenever there was a need to recover from disruption.

65 Current airspace design means aircraft join fixed approach paths at around 7-12 nautical miles. Future airspace re-design currently underway will reduce this distance.

9.33 These runway alternation schemes are shown in the figures below:

Figure 9.10: Runway alternation at the Heathrow schemes

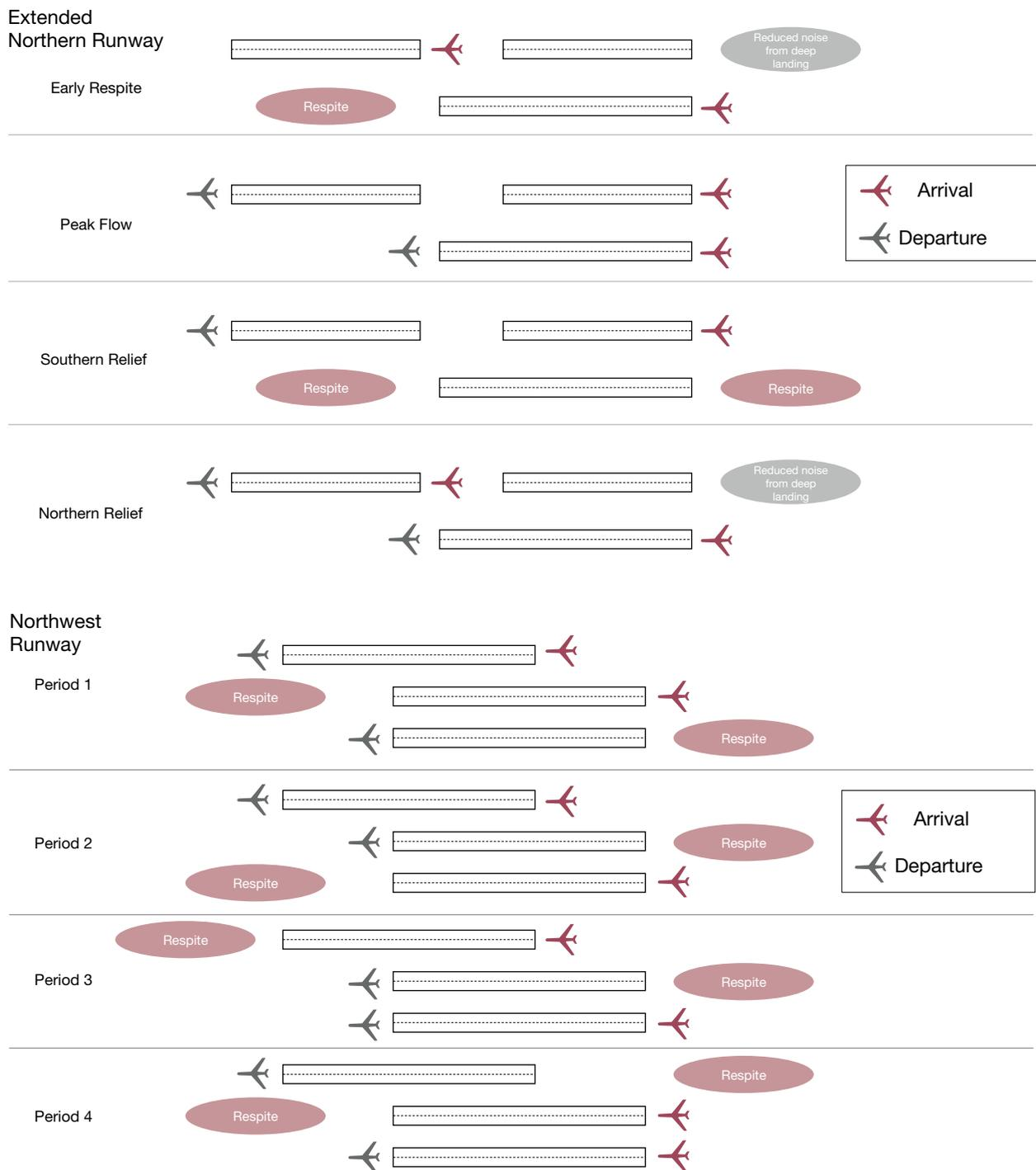

Source: Airports Commission analysis

- 9.34** Neither Heathrow scheme would be able to deliver the same level of respite through runway alternation as is currently provided, which sees communities around the airport generally benefiting from respite for half of the operating day. The Northwest Runway scheme would reduce this to a third, but would maintain the ability to offer respite throughout the operating day. The Extended Northern Runway scheme would reduce this further, as runway alternation would only be possible outside peak hours. In both cases, however, new navigational technologies would enable this to be supplemented with more effective respite through flightpath design.
- 9.35** Although not quantifiable at this stage, there is also potential for the respite provided through runway alternation be more predictable than today as resilience is enhanced through the provision of new capacity. This is true for both schemes, but the effects are likely to be greatest under the Northwest Runway proposal.
- 9.36** The Northwest Runway scheme would also be able to split arriving flights across three sets of approach paths, limiting the number of planes overflying any individual location as they come in to land. Communities should therefore benefit from respite from noise for one third of the airports' operational day. In contrast, the growing number of flights under the Extended Northern Runway scheme would still need to use the same two approach paths as are currently in operation, increasing the noise impacts felt by those underneath. The same applies to some degree for take-offs, but they can be more quickly dispersed over a number of departures routes.
- 9.37** So although the impacts of the two schemes are of broadly similar magnitude for the largest noise contours, and in some cases those of the Extended Northern Runway are smaller, for the contours representing higher noise levels its impacts are consistently greater.
- 9.38** Looking at the 55 decibel contour, which is based on a 24-hour assessment, the difference in population affected between the two schemes is less than 2,500 people in 2030 (556,200 compared to 558,600), and in 2040 and 2050 the Extended Northern Runway's impacts fall below those of the Northwest Runway scheme, in part due to the smaller number of air traffic movements that it can accommodate.
- 9.39** In contrast, for the higher 60 decibel 24-hour contour, the population affected by the Extended Northern Runway is more than 25,000 people larger (212,300 compared to 185,200). This difference does not fall below 17,000 people throughout the assessment period, despite the difference in the number of flights under the two schemes. A similar pattern is seen for the equivalent 65, 70 and 75

decibel metrics, and for the vast majority of the Commission's higher daytime, nighttime and number above contours.⁶⁶

- 9.40** The key noise advantage of the Extended Northern Runway scheme is that in the early morning period the extended runway can facilitate deep landings (with aircraft touching down further west, meaning that their altitude is higher over populated areas while on approach). This would noticeably reduce noise impacts from arriving flights for communities to the east of the airport. As discussed below, however, there are alternative measures which could address noise impacts in this period.

Mitigation

- 9.41** Given the significant importance attached by local communities to the noise impacts of aviation, it is important not only to consider the scale of those impacts but also how they might be mitigated or addressed. Aviation noise is predicted to reduce over the coming decades as new and quieter aircraft come into service and as more effective operational procedures are introduced, such as steeper landings and take-offs, which help to keep aircraft higher for a longer period. Conservative assumptions in relation to both of these have been incorporated into the Commission's forecasts. Therefore, the Commission's analysis of options for mitigation have focused on two other areas: night flights and insulation.
- 9.42** Night flights are considered particularly disruptive by local residents around both Heathrow and Gatwick. They can contribute to sleep disturbance, which may lead to both health impacts (such as an increased risk of hypertension) and lost productivity for people who have suffered from lack of sleep. As a result of responses to its consultation, a review of the health impacts of aviation noise, including night noise, was commissioned from a member of the Commission's Expert Advisory Panel, which has been published alongside this report. In addition, health and sleep disturbance effects were included in the monetisation of noise impacts used in the Commission's economic analysis set out in detail in the *Business Case*.
- 9.43** A number of consultation responses called for greater restrictions or a ban on night flights whilst others highlighted the economic value of such flights and argued for their continuation. The Commission has conducted further work to understand the value of night flights at each airport; and the impacts of a ban on the airport's

⁶⁶ The main exception to this pattern is the highest daytime N70 contour, for which the Northwest Runway scheme sees a worse performance than the Extended Northern Runway scheme. The number of people caught by this contour would, however, be comparatively small.

business model. This is discussed in more detail in **Chapter 14** and a summary is provided below.

9.44 Nighttime operations at Heathrow and Gatwick are subject to restrictions and a quota system based on the number of flights and the aircraft used (with noisier aircraft counting more heavily against the quota). These night quotas are agreed by government and subject to periodic review.

9.45 At Gatwick, night flights include arrivals and departures and the number of flights varies significantly between the summer and winter seasons, with an average of 40 a night during the core night period of 11:30pm to 6:00am. Low-cost airlines use night flights at Gatwick to enable them to fit in three or four waves of services in a single day and to maximise the use of their planes to reduce costs. The vast majority of nighttime services at Gatwick are therefore to and from short-haul destinations. While there may be potential for an expanded Gatwick and its airline community to evolve their business models over time, it is unlikely that any significant reduction in, or a ban on, night flights at an enlarged Gatwick would be a credible option in the immediate term. The level of rescheduling required would reduce the efficiency with which aircraft can be used, increasing costs in a price sensitive and highly competitive environment.

9.46 At Heathrow, under current arrangements, the quota system heavily restricts the number of flights that use can use the airport and the noise levels that they may create during the core night period from 11:30pm to 6:00am. In addition, the airlines using Heathrow have signed up to a voluntary agreement that no flights should land before 4:30am. This has led to an average of 16 arrivals from long-haul destinations between 4:30am and 6:00am each day and no departures.

Chapter 14 discusses in detail the Commission's conclusion that further restrictions on core night flights at an enlarged Heathrow would be credible and its recommendation that following construction of any new runway at Heathrow there should be a ban on all scheduled night flights between 11:30pm and 6:00am.

9.47 Noise insulation can also provide significant benefits for people living under an airport's flightpaths. The review of the health impacts of aviation noise carried out post-consultation highlighted its potential to mitigate these effects, particularly in relation to children's educational performance. It is important to recognise, however, that while insulation can reduce the impacts of noise its benefits should not be overstated. For example, its ability to improve people's enjoyment of outdoor space is limited, although some innovative schemes to enable outdoor learning at schools have been implemented. The promoters of the shortlisted schemes have proposed various options to fund insulation for homes and schools (and potentially other

community facilities). In **Chapter 14**, the Commission considers these alongside the promoters' wider proposals for community compensation and support and sets out its recommendations for how an appropriate package should be agreed and delivered.

Conclusion

- 9.48** Determining performance of the schemes against a wide range of quantitative noise measures is a complex process. Different communities and individuals consider different types of noise impact to be more or less important. Nonetheless, it is possible to draw conclusions on the relative noise performance of the three schemes.
- 9.49** Overall, against the Commission's objective **to minimise and where possible reduce noise impacts**, the Gatwick Airport Second Runway scheme performs best, due to the much smaller total numbers affected, and the smaller increment over the baseline across the majority of metrics. The scheme would, however, see higher noise levels than are currently experienced around the airport, and its impacts would be felt in some quieter and rural locations.
- 9.50** In terms of the other two schemes, the Heathrow Airport Northwest Runway scheme performs better than the Heathrow Airport Extended Northern Runway, in large part because the latter does not provide the same opportunities to maintain effective day-long respite through runway alternation without limiting capacity. The Extended Northern Runway scheme also affects more people than the Northwest Runway scheme in the majority of the higher noise contours, both during the day and at night.
- 9.51** All three schemes would have some negative consequences for the local noise environment around the shortlisted airports and therefore identifying effective mitigations to address these would be important. The Commission's proposals for achieving this in relation to its recommended scheme are set out in **Chapter 14**.

Air Quality

- 9.52** Proper assessment of the air quality impacts of an airport expansion scheme is important to enable an understanding of that scheme's likely impacts on human health. Moreover, limits on air quality are enshrined in domestic and European legal frameworks; the delivery of any scheme would be dependent upon compliance with these frameworks.
- 9.53** Emissions are created by both airport-related activity (including both aircraft engine emissions and emissions from other sources) and background activity. The Commission's appraisals therefore needed to take into account both the specific impacts of schemes on emissions levels and the cumulative effect of those scheme-specific emissions on background road transport emissions levels.

The legal frameworks

- 9.54** The **European Directive on Air Quality and Cleaner Air for Europe** (Directive 2008/50/EC, referred to as the Air Quality Directive within this document) entered into force on 11 June 2008 and required Member States to incorporate a set of Air Quality Limit Values – limits on the concentration of various pollutant (NO_x and particulate matter) in the outdoor air for protection of health and ecosystems, listed out in **Table 9.1** below – into national legislation before 11 June 2010.

Table 9.1: Air Quality Directive limit values

Pollutant	Obligation (annual mean)
Human health	
Nitrogen Dioxide (NO ₂)	40µg/m ³
Particulate Matter (PM ₁₀)	40µg/m ³
Particulate Matter (PM _{2.5})	25µg/m ³ (by 2015)
Particulate Matter (PM _{2.5})	20µg/m ³ (indicative by 2020)
Ecosystems	
Nitrogen Oxides (NO _x)	30µg/m ³

Source: Jacobs

- 9.55** In the UK, the Air Quality Standards Regulations 2010 implement the requirements of the Directive; and as compliance with the Regulations is primarily a national obligation, responsibility for meeting the EU limit values enshrined within the regulations lies with the UK Government. The UK is obliged to report on compliance

to the European Commission on an annual basis. Local authorities also have a duty to manage local air quality, discussed in detail in the Air Quality Strategy and Local Air Quality Management Plans section below. Local air quality duties are based on the same limits on emissions as the objectives monitored at a national level, although the approach to assessment and monitoring differs.

- 9.56** Assessment of compliance with the EU limit values takes place at a minimum number of local sampling points across the UK. In the vicinity of the Heathrow site, relevant locations include the parts of the A4 and A406 around Heathrow. In the vicinity of the Gatwick site, relevant locations include parts of the A23.
- 9.57** The UK currently meets European air quality standards for nearly all pollutants, with the exception of nitrogen dioxide limits alongside roads in cities and towns.
- 9.58** Following the recent Supreme Court ruling⁶⁷ the UK Government is required to submit an action plan to the European Commission by the end of 2015 detailing how it will meet the standards for nitrogen dioxide.
- 9.59** **The UK Air Quality Strategy and Local Air Quality Management Plans:** this strategy was introduced as a requirement of the Environment Act 1995. It was first published in 1997 and then updated in 2000, 2003 and 2007. It provides UK air quality standards and objectives for key air pollutants, and sets out how different sectors including industry, transport and local government can contribute to achieving these objectives.
- 9.60** Local authorities are obliged to play a central role. The strategy put in place a Local Air Quality Management Regime, whereby every local authority has to carry out regular reviews and assessments of air quality in its area and identify whether the objectives have been or will be achieved at relevant locations and by target dates. If they will not, the authority must declare an Air Quality Management Area and prepare an action plan that identifies and implements a set of appropriate measures.
- 9.61** The air quality objectives apply at locations where members of the public are likely to be regularly present and are likely to be exposed – effectively, where people live and work. The Commission’s assessment of air quality emissions, where emissions have been measured across defined study areas, describes whether an Air Quality Management Area is located within a particular study area.

67 R (on the application of ClientEarth (Appellant)vs Secretary of State for the Environment, Food and Rural Affairs (Respondent). Available at: https://www.supremecourt.uk/decided-cases/docs/UKSC_2012_0179_PressSummary.pdf

9.62 The 2001 National Emissions Ceilings Directive (NECD) sets binding limits on Member States for the national emissions of four pollutants (NO_x, sulphur dioxide, ammonia and non-volatile organic compounds) to be achieved by 2010 and not to be exceeded thereafter. The UK is currently compliant with this 2010 national ceiling. The NECD is being revised to set ceilings for 2030. For the UK, the proposed ceilings are percentage reductions relative to emissions in 2005: a reduction of 73% for NO_x and of 47% for PM_{2.5}.

9.63 The Gothenburg Protocol, agreed as part of the United Nations Economic Commission for Europe (UNECE) Convention on Long Range Transboundary Air Pollution,⁶⁸ sets national emission reduction targets including for fine particulate matter, to be achieved by 2020. The UK has agreed to reduce its NO_x emissions relative to 2005 by 55% in 2020; and its PM_{2.5} by 30%.

9.64 The National Planning Policy Framework (NPPF) sets out planning policy for England, placing a general presumption in favour of sustainable development, stressing the importance of local development plans and stating that the planning system should perform an environmental role to minimise pollution. In particular, the NPPF states that:

‘Planning policies should sustain compliance with and contribute towards EU limit values or national objectives for pollutants, taking into account the presence of Air Quality Management Areas and the cumulative impacts on air quality from individual sites in local areas. Planning decisions should ensure that any new development in Air Quality Management Areas is consistent with the local air quality action plan.’

9.65 The implications of this are discussed further in **Chapter 14**.

9.66 The National Networks National Policy Statement (NN NPS) (DfT, 2014) sets out Government’s policies on the development of nationally significant infrastructure projects on the national road and rail networks in England. With regard to air quality impacts and the decision making process, the NN NPS states:

“The Secretary of State must give air quality considerations substantial weight where, after taking into account mitigation, a project would lead to a significant air quality impact in relation to EIA and/or where they lead to a deterioration in air quality in a zone/agglomeration” (Para 5.12); and

68 <http://www.unece.org/env/lrtap/>

“The Secretary of State should refuse consent where, after taking into account mitigation, the air quality impacts of the scheme will:

result in a zone/agglomeration which is currently reported as being compliant with the Air Quality Directive becoming non-compliant; or

affect the ability of a non-compliant area to achieve compliance within the most recent timescales reported to the European Commission at the time of the decision.” (Para 5.13).

Methodology

- 9.67** Ahead of its national consultation exercise in November 2014, the Commission undertook a mass emission assessment, which predicts the increase in emission levels given the overall scale of the airport expansion and the anticipated growth in both airfield operations and airport-related surface transport trips. The results of this assessment were compared to UK-wide levels to check for compliance with the national emissions ceiling. The Commission also looked at the broad scale of the local impacts by reviewing the current risks of exceeding the EU limit values at sampling points close to the airport.
- 9.68** This level of assessment was sufficient to enable both the Commission and those responding to the consultation to understand the likely broad impacts of schemes upon air quality levels. However, in its *Appraisal Framework*, the Commission had indicated its intention to undertake dispersion modelling of air quality impacts. This is a more sophisticated form of modelling, which is dependent upon outputs from dynamic surface transport modelling. The range of inputs required and the complexity of the work required meant that it was not possible to undertake these forms of modelling in the time for the November 2014 consultation and the Commission decided that it was not necessary or proportionate to delay the wider consultation while this work was carried out. Accordingly, the wider consultation set out the commission’s intention to complete the dispersion modelling over the coming months. A number of consultation responses emphasised the desirability of this work and expressed a view that it should be subject to a further consultation.
- 9.69** The dispersion modelling provides a finer spatial resolution, to allow assessment of how the pollutants impact on local health-based receptors (located where pollutants will have an impact on human health and so located where people live and work) and sensitive ecological sites. Dispersion modelling takes into account the details of aircraft movements around and in the vicinity of the airport site, the volumes of traffic on specific sections of the road network throughout the day and meteorological factors such as prevailing wind conditions.

- 9.70** In defining the parameters to be used for the dispersion modelling exercise, the Commission decided to represent a plausible worst case scenario, which used the highest available forecasts for both aircraft and surface access movements compatible with the likely business model for each scheme. The modelling was conducted on the basis of conservative assumptions regarding developments in engine technology and the potential for mitigation measures to reduce emissions levels. It enables a quantified consideration of the impacts of schemes on health-based receptors, as well as their ability to comply with the Air Quality Directive. The results were shown on an unmitigated basis and mitigations either quantitatively or qualitatively assessed where air quality limits were predicted to be in exceedance.
- 9.71** The Commission published the results of the dispersion modelling for public consultation on 8 May 2015. The consultation ran for three weeks and received more than 1,800 responses, including a number of highly technical responses. The Commission's detailed consideration of these responses is summarized in the report *Consideration of Air Quality Consultation Responses*.

Impacts on human health

- 9.72** None of the health-based receptor locations assessed is predicted to have an annual mean NO₂ concentration above the air quality objective of 40 µg/m³ either with or without expansion.

Table 9.2: Highest forecast annual mean NO₂ levels at health-based receptors

Scheme	Forecast value with expansion (µg/m ³)	Change to do minimum (µg/m ³)	Receptor location
Gatwick Second Runway	38.6	+4.6	South of the airport, close to the A2011 in Crawley
Heathrow Extended Northern Runway	37.2	+9.8	North of the extended runway, close to the A3044
Heathrow Northwest Runway	34.7	+0.4	North-East of the airport on the Bath Road (A4)

Source: Jacobs

- 9.73** The number of properties considered to be at risk (defined for the purposes of the Commission's work as being exposed to emissions more than 32µg/m³ of NO₂)

varies between the schemes. The average increase to annual mean NO₂ concentrations at affected properties is higher at Gatwick compared to the Heathrow schemes, although the Heathrow Northwest Runway scheme results in the largest number of properties experiencing increases of NO₂ concentrations and the Heathrow Extended Northern Runway scheme results in the largest increase in the number of at risk properties.

Table 9.3: Wider human health impacts

Scheme	Average increase in mean NO ₂ levels across affected properties (µg/m ³)	Properties exposed to increased NO ₂	Properties considered at risk
Gatwick Second Runway	2.1	20,985	62
Heathrow Extended Northern Runway	0.7	38,656	113
Heathrow Northwest Runway	0.9	47,063	14

Source: Jacobs

Impacts on ecosystems

9.74 The impacts on local designated sites are determined by their location, their current exposure to different pollutants, and the percentage changes from baseline values. Gatwick performs better overall showing smaller percentage increases in pollutants (the highest increase for a site for the Gatwick Second Runway scheme being 1.7%, compared to 11.8% for Heathrow Northwest Runway and 19.6% for Heathrow Extended Runway). Advice from Natural England, contained within their response to the air quality consultation, has indicated, however, that the sites around Gatwick are more likely to be sensitive to changes in air quality than the sites around Heathrow.

9.75 None of the schemes cause any new exceedances of the lower or upper bound of the sites' Critical Loads (the rates below which significant harmful effects to sensitive ecosystems are unlikely to occur).

Compliance with EU legislation

9.76 While none of the schemes would lead to an exceedance of air quality objectives at any receptor relevant to human health in 2030, the Air Quality Directive places

further obligations upon the UK to reduce emissions. This includes emissions levels measured across a different range of receptors.

- 9.77** The UK is not forecast to be compliant with the Directive in terms of NO₂ emissions in the Greater London Agglomeration area by 2030, even without airport expansion. Following the Supreme Court ruling referred to above, the UK Government is required to submit an action plan to the European Commission by the end of 2015 detailing how it will comply with the limits as soon as possible.
- 9.78** The Heathrow site is contained within this area and itself contains a number of locations at which emissions are expected to be in exceedance in 2030, most notably at points on the A4 Bath Road, immediately to the north of the current airport boundary, with further, lower exceedances forecast on the A4 (junction of Fulham Palace Road to Earls Court Road) and A40 on the routes from the airport to Central London.
- 9.79** When expansion options are taken into account, the impacts of the two Heathrow schemes vary considerably, reflecting the differing configurations of motorway junctions, local roads and airport access roads in the vicinity of the expanded airfield sites as well as the proximity to receptors of the runways and their aircraft operations. While results are generally similar for the receptors on the A4 (Fulham Palace Road and Earls Court Road) and A40, the forecast exceedance for the Bath Road receptor is significantly higher in the case of the Heathrow Extended Runway scheme. This is partly due to the different configuration of access roads, which the Commission's dynamic surface access modelling has shown would increase usage of the Bath Road, but also due to the proximity of both sections of the intensively used extended runway to the Bath Road.
- 9.80** The Gatwick Second Runway scheme is not forecast to cause any exceedances of legal limits by 2030.
- 9.81** In order for the Commission to determine that a scheme can be delivered in compliance with the Air Quality Directive, it would require assurance that the scheme would not delay the date by which the sector within which the scheme was located would reach compliance with the limits set out within the Directive. In the case of the Heathrow schemes, the relevant sector is the Greater London Agglomeration area. It would therefore need to be demonstrated that, by 2030, receptors in the vicinity of the expanded airport site would not report the highest concentrations of NO₂ in the sector. Without Heathrow expansion, the Marylebone Road is expected to report the highest concentrations in 2030.

9.82 The Commission’s dispersion modelling has shown that using pessimistic assumptions and without actions to mitigate emissions, both of the Heathrow schemes would result in NO₂ concentrations on the Bath Road in 2030 which would be higher than those on the Marylebone Road. Therefore, absent mitigation, both schemes would delay compliance with the Directive and hence would not be deliverable within the legal framework.

Table 9.4: Unmitigated 2030 impacts of the Heathrow schemes on Bath Road NO₂ concentrations

Scheme	Marylebone Road concentration (µg/m ³)	Do minimum forecast (µg/m ³)	Scheme forecast (µg/m ³)	Incremental change (µg/m ³)
Heathrow Extended Northern Runway ⁶⁹	48.6	47.4 to 47.6	50.3 to 55.8	+2.8 to +8.2
Heathrow Northwest Runway	48.6	47.4	48.7	+1.3

Source: Jacobs

9.83 The extent to which the predicted Bath Road concentrations would exceed levels on the Marylebone Road would be significantly higher in the case of the Extended Northern Runway scheme.

Mitigating local air quality impacts

9.84 The results do not in themselves rule out either Heathrow scheme being deliverable within the legal framework. There are mitigating actions which could be taken to reduce both background road emissions and those emissions arising from airport activities.

9.85 There are many possible mitigating actions available to the airport operator to limit emissions, which would produce lower emissions forecasts than demonstrated in the worst case results described above. The Commission has considered, and where appropriate quantified, mitigating actions that range from achieving better public transport mode share, to NO_x emissions charging for airlines to providing incentives for airlines to shut down an engine during taxiing. Detail on these possible mitigations were set out in the air quality report published for consultation in April

⁶⁹ The configuration of the Extended Northern Runway means that two receptors on the Bath Road are relevant for that scheme, while only one is relevant for the Northwest Runway scheme.

2015⁷⁰ at sections 4.6.3, 5.6.3 and 6.6.3. The possible mitigating actions assessed by the Commission are by no means an exhaustive list and there may be more ambitious strategies available to tackle the issue. These could encompass such things as rerouting roads or remodeling airport facilities, although these are likely to be costly, time consuming and may often have fundamental implications for the nature of the scheme. They have therefore not been considered by the Commission at this stage.

- 9.86** Overall, the mitigating actions that the Commission has been able to quantify show a total potential reduction in the change in NO₂ concentrations at the Bath Road PCM exceedance area of between -2.4µg/m³ and -3.6µg/m³ for Heathrow Northwest Runway and between -4.45µg/m³ and -6.05µg/m³ for Heathrow Extended Runway.
- 9.87** Such a reduction would ensure that the NO₂ concentrations on the Bath Road for the Heathrow Airport Northwest Runway scheme would be substantially below levels on the Marylebone Road, meaning that the scheme would not be delaying compliance with the Directive. Even if demand growth at the airport is as high as in the modelling it is reasonable to proceed on the basis that suitable mitigating actions are available to reduce the impact of the Heathrow Northwest Runway scheme to a level where other measures employed to tackle the wider air quality problem can be expected to bring the identified exceedances within legally required limits.
- 9.88** In respect of the Heathrow Airport Extended Runway scheme, the Commission notes that even assuming that all the quantified mitigating actions were effective, it would not be possible to state reliably that NO₂ concentrations on the Bath Road would be lower than those on the Marylebone Road by 2030. In order to render the scheme compliant with the Directive, it may be necessary to consider more dramatic mitigating actions, above and beyond those which the Commission believed it was credible to assess at this stage.
- 9.89** The recent Supreme Court ruling means that the Government has been ordered to take action on air quality, producing an action plan by the end of the year in order to bring forward the national and regional measures required to resolve the background air quality issue. It is reasonable to expect that the proposals in that plan would reduce emissions from road vehicles and so further reduce the unmitigated levels set out above. As set out in **Chapter 14** the Commission recommends that the development and successful delivery of mitigations, along

70 https://www.gov.uk/government/uploads/system/uploads/attachment_data/file/426241/air-quality-local-assessment-report.pdf

with active monitoring of emissions levels, should be a necessary condition of allowing an increase in aircraft operations at Heathrow. In particular, slot capacity at an expanded Heathrow should only be released when it is clear that the air quality at sites around the airport will not delay compliance with the Air Quality Directive.

National impacts

9.90 At the national level all three schemes would increase emissions of NO_x, PM₁₀ and PM_{2.5} compared to the do minimum baseline.

Table 9.5: 2030 Impacts of schemes on national NO_x and PM_{2.5} emissions levels compared to Gothenburg and NECD targets

	NO _x (kt/yr)	PM _{2.5} (kt/yr)
NECD 2010 target	1,167	N/A
Proposed NECD 2030 target	410 – 440	44 – 50
Gothenburg Protocol 2020 target	714	67
2030 do minimum ⁷¹	585.7	50.7
2030 Gatwick Second Runway	587.6	50.8
2030 Heathrow Extended Northern Runway	587.7	50.8
2030 Heathrow Northwest Runway	588.2	50.8

Source: Jacobs

9.91 Although expansion results in increases in emissions these levels are small when viewed in the national context. For this reason, as discussed in more detail in the *Sustainability Assessment*, none of the schemes materially alter the likelihood of the UK exceeding the National Emissions Ceilings and the Gothenburg targets. If the NECD is tightened in line with current proposals (as shown in the table above), the UK would exceed the obligations with or without any of the schemes. Any future strategy developed by the Government to achieve compliance with EU limit values would, however, also be expected to reduce emissions at national level.

Performance against Commission's objectives

9.92 Against the Commission's objective **to improve air quality consistent with EU standards and local planning policy requirements** none of the schemes improve air quality compared to a scenario where no expansion takes place. The Gatwick scheme, however, performs best. It causes neither any predicted

71 Based on the National Atmospheric Emissions Inventory (NAEI) projections.

exceedances of air quality limits at any health-based receptor locations nor any predicted exceedances of the EU Air Quality Directive limit values.

- 9.93** Both Heathrow schemes could, without mitigation, exceed the Air Quality Directive limit values and delay compliance with the EU limit value for the Greater London agglomeration. Initial analysis, however, suggests that even in this worst case demand scenario, quantifiable mitigating actions, such as the use of fixed electrical power by aircraft on stands, could reduce the exceedance of the Northwest Runway scheme to levels below those of the worst in the sector, meaning that the scheme would not delay compliance with the Directive. The Commission therefore believes that this is a manageable part of a wider problem that Government is now obligated to address in light of the recent Supreme Court ruling. The Commission further considers that it is feasible that the Government can devise and implement appropriate measures to address the wider problem. The Commission therefore places limited weight on suggestions that air quality represents a significant obstacle to the delivery of expansion at Heathrow.
- 9.94** In the Commission's view the challenges associated with the Extended Northern Runway scheme are greater, as it has not been able to identify quantified mitigations which would bring NO₂ concentrations below the levels of the highest exceedance in the zone. Significant further mitigations, likely to involve very high costs or fundamental changes to the scheme design, would be required to achieve this. Therefore it is reasonable to conclude that the Extended Northern Runway scheme represents a greater risk to compliance with EU legislation than either of the alternative options.
- 9.95** The results presented in this section are based on a worst case demand scenario and it would be reasonable to expect that in lower demand scenarios the potential exceedances would be reduced.
- 9.96** Local and national Government will need to work together with the scheme promoter to develop a robust set of mitigations to manage both background and airport demand. The Commission is proposing that the release of new slot capacity should be linked to progress in tackling emissions. This is described in more detail in **Chapter 14**.

Biodiversity

Methodology

9.97 The Commission considered three key areas with respect to the biodiversity impacts of each scheme:

- the direct land take impacts of the scheme e.g. any designated sites or priority habitats that will be lost due to the physical development of the scheme;
- non land take impacts of the scheme for instance, noise, air quality and water quality impacts on local designated sites; and
- ecosystems services impacts: the impact of biodiversity changes on services on which human life is dependent, for instance the production of food, the availability of drinkable water, and the cultural value of areas of biodiversity as places of recreation or inspiration.

Assessment of biodiversity impacts

9.98 The schemes would all have direct land take impacts on some local statutory and non-statutory designated sites and SSSIs,⁷² and would lead to losses in some priority habitats such as deciduous woodland. In particular the Heathrow Northwest Runway scheme has a potential impact on a nationally rare plant species (Pennyroyal) and the Gatwick Second Runway scheme would result in the loss of some ancient woodland (**Figure 9.11**).

9.99 Each scheme also has non land take impacts on designated sites and SSSIs through its air quality, noise and water quality impacts and on bird populations due to bird strike control measures. The bird strike issues are particularly important at Heathrow, due to the use of nearby reservoirs by geese and gulls. The lengthened runway in the Extended Northern Runway scheme in particular could bring these bird populations into conflict with departing planes. The two Heathrow schemes would also culvert rivers, while the Gatwick scheme would deculvert one, returning it to a more natural state.

72 Site of Special Scientific Interest

Figure 9.11: Local designated sites at the schemes

Gatwick Airport Second Runway

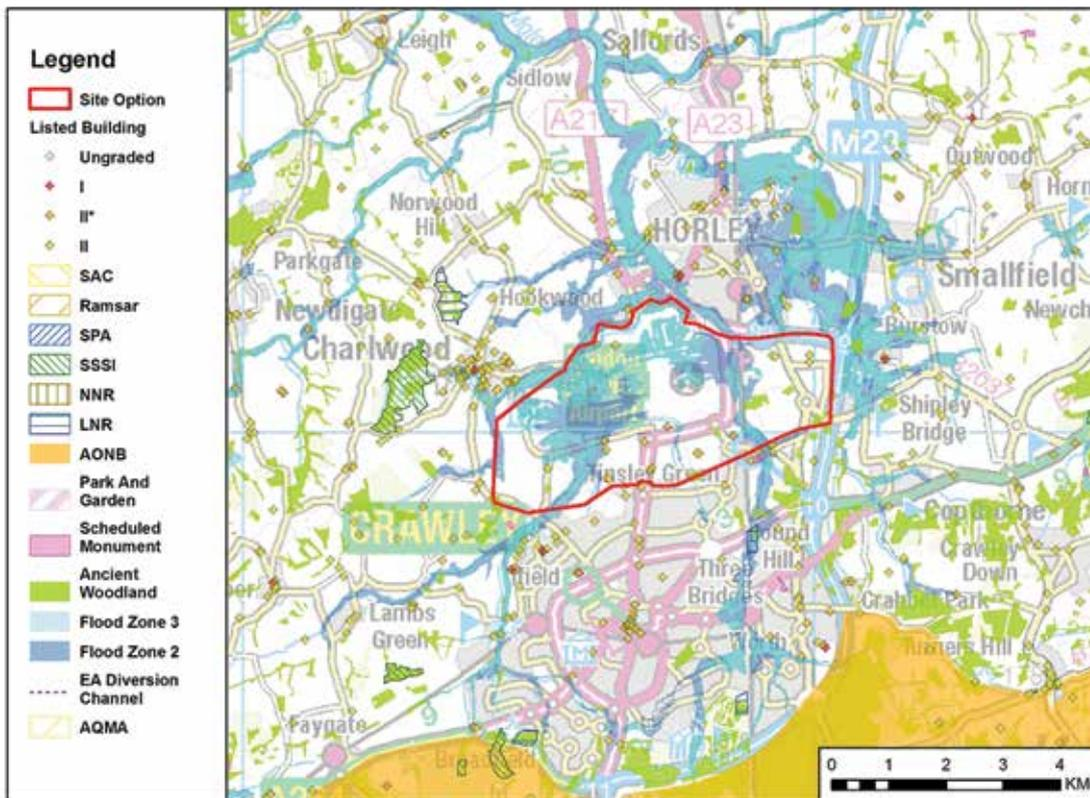

Heathrow Airport Extended Northern Runway

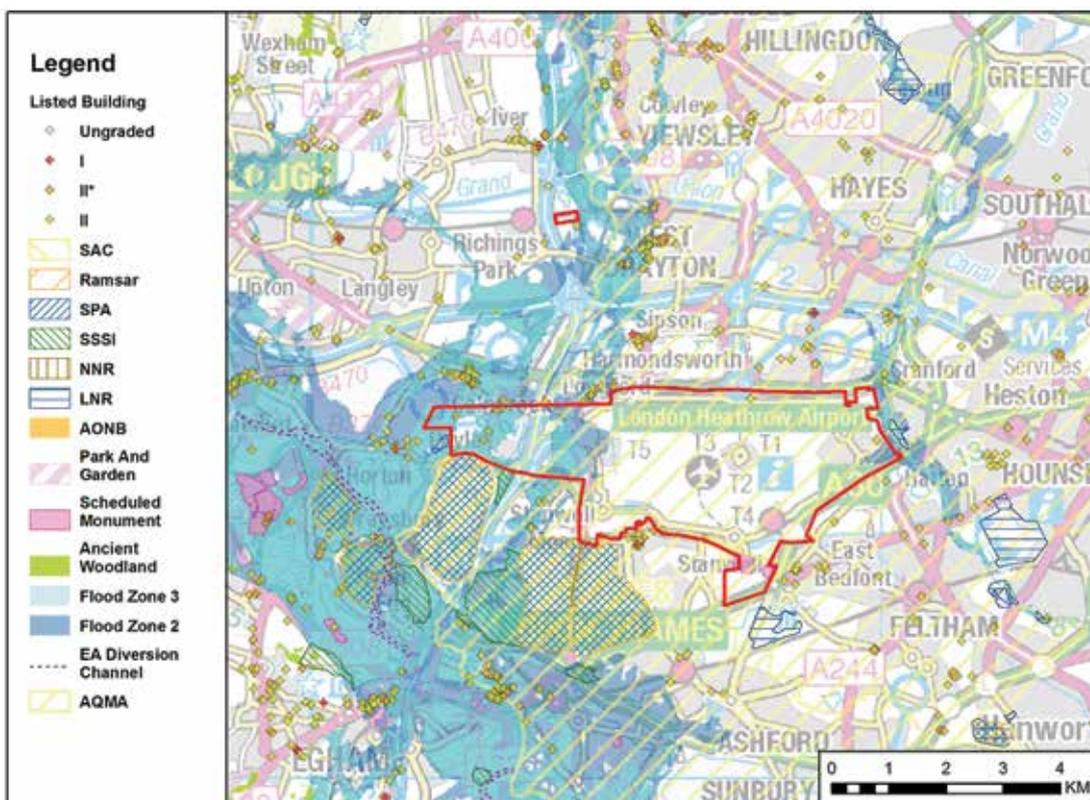

Heathrow Airport Northwest Runway

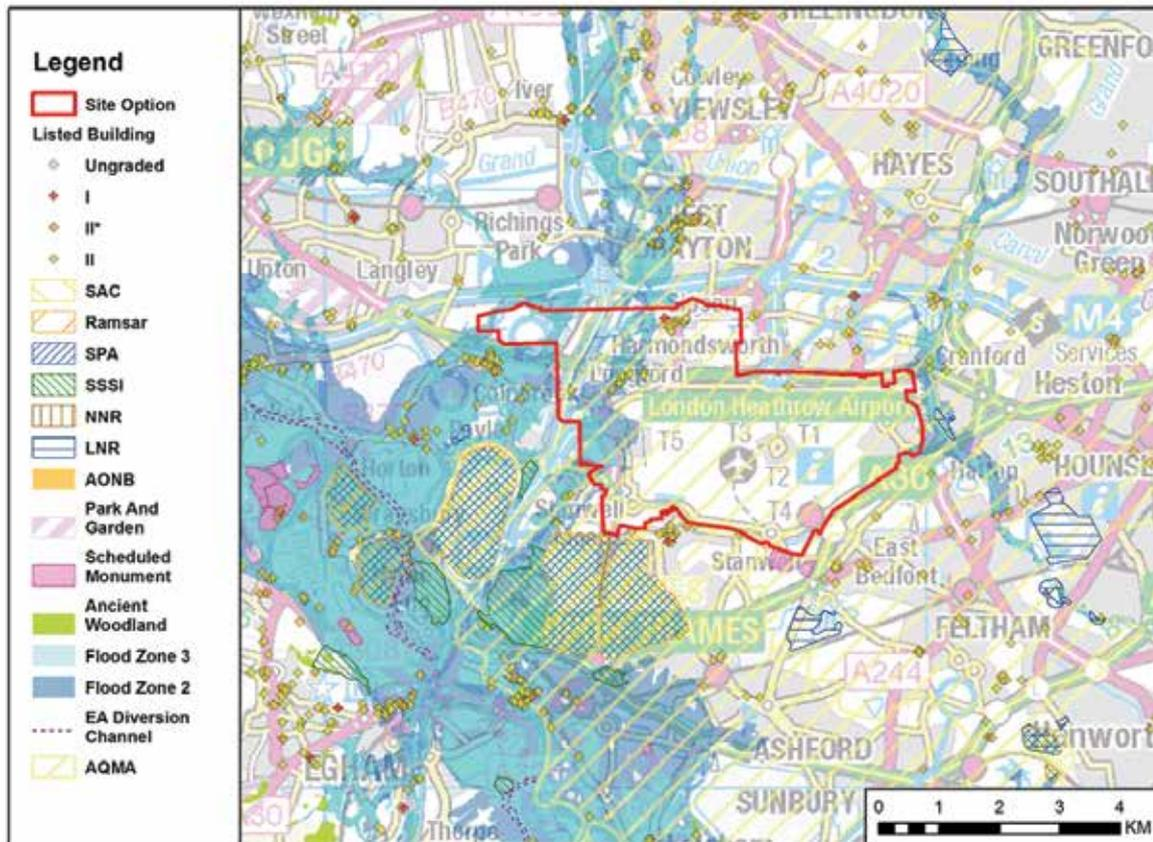

Source: Jacobs

Ecosystem services

9.100 Ecosystem services are the processes which provide the environmental goods and services on which human life is dependent, through physical goods such as water for drinking or cultural goods such as recreational space, and the services which support them (such as sites for pollinating bees). Full results of the impact on these services of each scheme are set out in the *Sustainability Assessment* and supporting documents. In total the monetised costs associated with these are £5-9 million for the Gatwick scheme, and £6-16 million for each of the Heathrow schemes.

Mitigations

9.101 These biodiversity impacts could all be mitigated to a degree through good design and operations, and for all of the schemes an Appraisal of Sustainability (for which the Commission’s analysis may provide a valuable foundation) and subsequently a full Environmental Impact Assessment would need to be undertaken at later stages in the planning process.

- 9.102** An Appropriate Assessment under the Conservation of Habitats and Species Regulations 2010 is also likely to be required, particularly for the Heathrow schemes, but the Commission is satisfied in light of the evidence base that it has assembled that it is reasonable to conclude that there would be a very good likelihood of any such assessment determining that the project would not adversely affect the integrity of any designated Special Protection Area (SPA) site. Further work would be required to demonstrate this, however, in relation to the bird populations using the reservoirs to the west of Heathrow and the ongoing management of any mitigation or avoidance measures.
- 9.103** The new public green space being proposed by Heathrow Airport Ltd, while not having a strong biodiversity impact itself, could help to reconnect areas of high biodiversity, allowing populations to move between these areas and not become isolated.
- 9.104** Many respondents to consultation pointed to the need for further detailed analysis of these impacts. Doing this level of analysis on such a high level design would, however, create a risk of drawing detailed conclusions which may prove inaccurate once fuller work on design and mitigation has been completed. The analysis so far has been conducted at a level of detail appropriate for determining the broad impacts of the scheme.

Conclusion

- 9.105** The biodiversity impacts of expansion at Heathrow and Gatwick differ significantly in their nature and any comparison between them must therefore necessarily be qualitative.
- 9.106** The impacts of the two Heathrow schemes are similar in character but differ in severity. Both schemes raise potential bird strike control issues (potentially affecting an internationally designated site) and require a challenging programme of watercourse diversions including culverting. The Northwest Runway scheme would also have an impact on a nationally rare plant species (Pennyroyal), whereas the Extended Northern Runway scheme would entail more extensive culverting of rivers and, due to its runway placement, could have a more significant impact on the bird populations using the designated site to the west of the airport. These factors need to be weighed against the Gatwick scheme's loss of irreplaceable ancient woodland and a smaller scale but still significant river diversion scheme.

9.107 Therefore, against the objective **to protect and maintain natural habitats and biodiversity**, overall the irreplaceable nature of the loss of ancient woodland due to the Gatwick Second Runway is assessed to be similar in severity to the potential impacts on Pennyroyal and designated sites as a result of the Heathrow Northwest Runway scheme, but the Heathrow Extended Northern Runway has potentially a more severe impact overall.

Carbon

Methodology

9.108 The Commission has considered the carbon impact of the scheme across four areas:

- increased airport capacity leading to a net change in air travel;
- airside ground movements and airport operations;
- changes in non-aviation transport patterns brought about by a scheme's surface access strategy; and
- construction of new facilities and surface access infrastructure.

9.109 The results of the carbon assessment presented here have been calculated using the carbon-capped forecast, in which total aviation emissions are in line with the Committee on Climate Change's (CCC) planning assumption of 37.5MtCO₂ in 2050. A sensitivity analysis has also been undertaken since consultation on the impacts in a carbon-traded scenario and this is discussed in the *Sustainability Assessment*.

9.110 Several consultation respondents commented on the need for a fuller economic analysis incorporating the CCC's planning assumption for aviation emissions. This is discussed in detail in the Economic section of this report, and in the *Business Case*.

Assessment carbon dioxide emissions from flights and ground movements

9.111 Air Transport Movements (ATMs) and ground movements are by far the largest sources of total emissions from aviation. The emission levels from this source in the carbon-traded case are higher from the Heathrow schemes than from a second runway at Gatwick, as Heathrow sees a larger proportion of long-haul flights, which have higher carbon impacts. The emissions of carbon dioxide in the carbon-capped case are equal by 2050 for all schemes.

9.112 All of the Commission's forecasts incorporate measures to ensure that carbon dioxide emitted by UK flights and ground movements does not lead to increased emissions overall either at international level (in the carbon-traded forecast) or within the UK economy (in the carbon-capped forecast). Therefore, the increases in emissions from flights are not additional and are not monetised in the Commission's economic analysis of carbon impacts, which focuses on the Commission's objective to reduce carbon emissions from the construction and operation of the airport itself.

Assessment of other airport emissions

9.113 Airport operations are dependent to a large extent on the nature and scale of the passenger and support facilities at the airport, and the larger scale of both of the Heathrow schemes explains the greater emissions from them relative to Gatwick. However, because grid electricity use is such a large part of the operational energy used (about two thirds of the 2026 carbon emissions for the Heathrow Northwest Runway, for example) and the carbon dioxide emissions from this source are expected to decrease per kW of power with technology improvements, both the do minimum and with scheme forecasts show lower levels of carbon produced in 2050 than in 2025.

Assessment of surface access emissions

9.114 All schemes result in additional emissions from surface access compared to the do minimum, with the highest level of additional carbon dioxide due to passenger surface access produced by the Gatwick Airport Second Runway scheme.

9.115 There are two factors driving this result. First, the Gatwick scheme provides the greatest number of additional passengers, relative to today, whose journeys to and from the airport lead to increased carbon dioxide emissions.

9.116 Second, at the national level, both schemes at the Heathrow site produce a decrease in total surface access emissions as passengers who move into an expanded Heathrow do so from airports where the mode share is more heavily weighted towards road than rail. The same trend is also seen in the Gatwick option but to a lesser extent.

Assessment of construction emissions

9.117 In addition to the ongoing impacts described above the construction of new facilities and infrastructure will have a one-off carbon dioxide impact. For the Gatwick scheme this is expected to be approximately 3.9 million tonnes, much of this occurring in 2025. For the Heathrow schemes the impact is mainly in 2026, and substantially higher, with the Northwest Runway scheme emitting 11.3 million tonnes and the Extended Northern Runway scheme emitting 10.1 million tonnes.

Conclusion

9.118 **Table 9.6** provides a summary of the Commission's assessment of carbon emissions from the three shortlisted schemes.

Table 9.6: Carbon assessment findings, change in MtCO₂(e) over the appraisal period, carbon-traded (CT) and carbon-capped (CC), assessment of need⁷³

Area of Emissions	Gatwick Second Runway		Heathrow Extended Northern Runway		Heathrow Northwest Runway	
	CT	CC	CT	CC	CT	CC
Passenger surface access	11.5	6.6	7.1	4.9	8.4	5.7
Airport operations (energy and fuel use)	1.1	0.8	2.1	1.8	2.6	2.2
Construction of airport facilities and surface access infrastructure	3.9	3.9	10.1	10.1	11.3	11.3
Total	16.5	11.2	19.3	16.8	22.2	19.2
Air travel at the expanded airport (not included in monetised assessment)	110	68.9	260	210.4	309.9	236.7

Source: Jacobs

9.119 The Gatwick Second Runway is associated with the lowest additional emissions. Both Heathrow schemes produce relatively higher emissions than Gatwick, with the Northwest Runway performing the worst due to an overall higher number of passengers and ATMs and a larger construction programme.

9.120 The Commission's objective **is to minimise carbon emissions in airport construction and operation**. Overall the Gatwick Airport Second Runway scheme is judged to perform best on this objective, even allowing for its less positive impact on surface access emissions. Of the two Heathrow schemes, the Extended Northern Runway performs marginally more strongly.

73 Construction emissions are accounted for in terms of CO₂(e). The remaining impacts are accounted in CO₂, however the difference for these resources is less than 1%.

Water and Flood Risk

Methodology

9.121 In assessing the implications of the shortlisted schemes for water and flood risk, three aspects have been considered:

- Water Quality – an assessment of the impact of the proposed schemes on the water environment and whether they would result in deterioration in the status of any water body designated for the purposes of the Water Framework Directive. A water body can comprise a watercourse, lake or reservoir or a groundwater resource;
- Water Quantity – consideration of potential impacts on water resources in terms of availability, reliability of supply, and replaceability, and assessment of any mitigation measures proposed to reduce detrimental impacts; and
- Flood risk – how the airport site and the local and wider area are protected from flooding, including how the creation and operation of the expanded airport would affect the operation of a floodplain.

9.122 Several respondents requested further detailed analysis of the potential effects of mitigation measures associated with these impacts. Analysis of this kind will be required for whichever scheme is taken forward as part of the planning process and various bodies (such as Thames Water) will need to be involved in developing plans, but given the stage of design it would have not been possible or appropriate to undertake this as part of the Commission process.

Scheme assessment

9.123 All three schemes would necessitate the diversion of one or more watercourses which would present technical challenges if deterioration in water quality is to be prevented.

9.124 At Gatwick the River Mole would be diverted around the western side of the airport. The resulting reduced gradient, addition of a weir and abrupt changes to the course of the river could contribute to adverse effects on its water quality, although this is offset by the beneficial effect likely to occur from removing it from culvert under the existing runway.

- 9.125** The changes required by both Heathrow schemes are more complex, involving the diversion of several rivers and streams and including placing some in culverts beneath the new runway. In the case of the Extended Northern Runway scheme, up to 12km of new culverts may be required. For the Northwest Runway scheme, there would be shorter culverts, but the watercourse diversions would be more extensive, including the creation of a new channel, the Colne Brook Spur. Careful and detailed design of the river diversion schemes would be essential, and even then some residual effects are likely.
- 9.126** Heathrow Airport Ltd has useful previous experience in this field, having overseen river diversions to permit the construction of Terminal 5. It is expected that the developer would work alongside the Environment Agency, as the regulator of water body changes, to benefit from best practice and therefore limit the potential impacts.

Water quantity and quality

- 9.127** The operation of an airport increases the risk of contaminants such as oil and de-icing fluid reaching watercourses. Both airport operators currently have facilities and procedures in place to manage such risks and have designed further mitigation into their respective schemes. These would also need to be considered in detail at a later stage of scheme development as part of the airport's plans for operation.
- 9.128** Examination of Water Quantity issues indicated that there is likely to be an adequate supply of water to meet the demand from an expanded Gatwick. The airport's recent success in reducing water usage per passenger also indicates an ability to reduce overall demand.
- 9.129** Water supply issues at Heathrow are more challenging, with the water company already experiencing difficulty in meeting local demand. Potential measures are available to reduce per-passenger consumption at the airport by 10-15% from current levels, but additional action would be likely to be necessary for either Heathrow scheme in order to meet local water quantity requirements. These might include investment in advanced water recycling technology and the importing of water from other sources.

Flood risk

- 9.130** All three schemes would include development in Medium- to High-Risk Flood Zones, causing loss of flood plain storage, diversion of major watercourses and development in an area already at significant risk from surface water flooding (**Figure 9.9**). For both

Heathrow schemes, these factors would be compounded by the culverting of major watercourses and major engineering works in an area of high groundwater levels.

9.131 The scheme promoters have all identified potentially effective proposals to mitigate the risks of off-site flooding, but they would need careful design as the scheme is developed to ensure a viable regime emerges. The scheme taken forward will need to satisfy Environment Agency requirements that it has measures in place to address flood risk concerns and meet water quality requirements under the Water Framework Directive.

9.132 A number of consultation responses raised concerns about increased flood risk, reflecting the history of flood events in areas close to both Heathrow and Gatwick. There were calls for the Commission to examine this issue in greater detail, but this would not be practicable until a scheme has been taken forward to the detailed design stage and the design of features such as river diversions, culverts and flood storage areas is complete, along with operational procedures for the expanded airport to ensure, for instance, that contaminated run-off is contained.

Conclusion

9.133 In considering the schemes against the Commission's objective **to protect the quality of surface and ground waters, use water resources efficiently and minimise flood risk**, the Gatwick Airport Second Runway scheme performs best in terms of water quantity and its less challenging programme of watercourse diversions is indicative of less risk around water quality standards and flooding. The December 2013 flood event when part of the airport was closed as a result of surface water flooding does however suggest that substantial risks remain and would require careful mitigation.

9.134 There is relatively little to differentiate between the impacts of the two Heathrow schemes, although the increased incidence of culverting associated with the Extended Northern Runway will present the greater challenges in maintaining water quality standards and mitigating off-site flood risk. There would be substantial challenges for either scheme promoter in completing the detailed design of a programme of watercourse diversions in the Colne Valley, with effective measures also needed to ensure that increased demand for water at an expanded Heathrow could be met. However, these challenges are not unusual for a project of this nature and scale and Heathrow Airport Limited has already begun work on developing mitigations. There is no reason to believe, therefore, that these challenges would undermine the viability of either of the Heathrow schemes.

Place

Introduction

9.135 In conducting its assessment of impacts on Place, the Commission considered four key areas:

- The direct land take impacts of the scheme – the land uses and properties that will be lost due to the physical development of the scheme;
- Landscape, townscape and visual impacts of the scheme – the effects that the new runway and associated development would have on the character of the local area, and on existing views from settlements and recreational areas;
- Heritage impacts of the scheme: the effects of the scheme on listed buildings and other designated heritage assets, both directly and on their settings; and
- Waste impacts of the scheme – the amount of waste that will be generated during construction and operation of the expanded airport, and proposals for its management.

Loss of land and property

9.136 The Gatwick Airport Second Runway proposal would entail greater direct land take due to the airport footprint than either of the other shortlisted schemes, requiring 624 hectares compared to 569 hectares for the Heathrow Northwest Runway and 336 hectares for the Extended Northern Runway.

9.137 In a number of other respects, however, the land take impacts of the Gatwick scheme would be lower than those of the other shortlisted proposals:

- Additional land take would be likely to be needed to deliver the surface access interventions associated with each scheme. While the final scale of this would depend on more detailed route and construction design, as well as on any mitigations adopted, the requirement around Gatwick would be likely to be significantly lower than around Heathrow, due to the smaller package of surface access works required. This could more than offset the higher land take for the airport footprint in comparison to the Heathrow Northwest Runway, and significantly narrow the gap in comparison to the Heathrow Extended Northern Runway.
- The Gatwick scheme would affect a much smaller area of Green Belt land – just 9 hectares, compared to more than 400 for the Northwest Runway and more than 250 for the Extended Northern Runway scheme.

- The agricultural land lost around Gatwick would also be of lower quality than that around Heathrow.
- The area around Gatwick is less developed than around Heathrow. The land take required for the Northwest Runway scheme, in particular, would cover all of Longford as well as parts of Harmondsworth and other nearby villages. The Extended Northern Runway's land take would incorporate parts of the village of Poyle.

9.138 All of the schemes would require the loss of a significant number of homes, with the impacts from the Heathrow Northwest Runway scheme noticeably higher than those of the other two proposals. This is discussed in more detail, including the scheme promoters' proposals for mitigation, in the next chapter.

9.139 The Heathrow Airport Northwest Runway scheme would also entail the loss of a number of commercial properties along the Bath Road, whereas the Extended Northern Runway would require the removal of the Poyle Industrial Estate. The Gatwick Airport Second Runway scheme would lead to the loss of a number of commercial premises outside the airport's south eastern boundary.

Impact on listed buildings

9.140 Both the Gatwick Second Runway and Heathrow Northwest Runway schemes would result in the loss of a substantial number of listed buildings, mostly Grade II but with several at threat around Gatwick having Grade II* status. A smaller number of listed buildings would be lost as a result of the Heathrow Extended Northern Runway scheme (**Figure 9.11**).

9.141 Although the quantity of listed buildings lost is highest at Gatwick, the overall impact is likely to be greatest for the Northwest Runway, where many of the listed buildings are concentrated in the Conservation Areas at Longford, which would be removed in its entirety, and Harmondsworth, part of which would be lost. There would also be impacts on the setting of other remaining assets such as Grade I listed Harmondsworth Great Barn, which would sit immediately outside the boundary of the expanded airport, though its demolition would not be required.

Effects on landscape and townscape

9.142 As well as these quantified impacts noted above, there are also more qualitative impacts of Place. These will include in particular the impacts on land that is not required for airport expansion, but will be significantly affected by the development through visual impacts such as changes to the skyline and loss of vegetation cover.

- 9.143** At Gatwick the visibility of the scheme would be relatively constrained to the north and south by the high density of vegetation within the surrounding area, with the most significant impacts on views being from the east and west. The scheme promoter has proposed extensive mitigation to address the visual impact of the new runway, including a comprehensive programme of landscaping to mitigate visual and noise impacts.
- 9.144** For the Heathrow Northwest Runway scheme, the landscape and townscape impacts would be dispersed, due to the large footprint of the scheme. In general these impacts will reduce after construction has been completed but the Hillingdon Lower Colne flood plain would continue to be severely impacted. The scheme promoter has proposed significant new green space as mitigations for some impacts.
- 9.145** The Heathrow Extended Northern Runway scheme has a much smaller land take than that for the Northwest Runway scheme, and as such the landscape and townscape impacts are more limited in scale, particularly during construction. However, as with the Northwest Runway scheme, the Hillingdon Lower Colne floodplain would continue to experience significant impacts during operation, and the effects would be more significant in this case as the runway would extend across it on an elevated section.

Waste management practices

- 9.146** An expanded Heathrow would generate up to 47,000 tonnes of waste by 2040, subject to the effectiveness of measures to reduce the amount of waste generated per passenger. For Gatwick, the figure is much lower at 14,500 tonnes per annum, although this is dependent on a number of factors – it could for instance increase if the airport were successful in attracting a significant increase in long-haul traffic. At either airport there would be a need to ensure that best practice waste management techniques are adopted, including investment in new waste handling facilities, and the Commission would expect the promoter of the recommended scheme to take such measures forward.

Conclusion

- 9.147** The performance of the schemes differs across the various topics assessed under the Place module – Land take, Landscape impacts, Heritage and Waste, all of which contribute to the Commission's objective **to minimise impacts on existing landscape character and heritage assets.**

- 9.148** In the Commission’s assessment, there is little to choose between the Heathrow Airport Extended Northern Runway and the Gatwick scheme, with the former’s modest land take footprint and heritage impacts roughly balanced by Gatwick’s smaller housing and Green Belt loss and limited waste generation. The Commission’s tranquility analysis discussed above indicated that the increase in flights over quiet rural areas as a result of expansion would be most marked for the Gatwick scheme.
- 9.149** Absent mitigations, the Heathrow Airport Northwest Runway scheme would appear to have the greatest adverse impacts. The scheme promoter has suggested a number of potential mitigatory measures, in particular the creation of compensatory recreational areas through the use of new landscaping areas and enhancing and linking existing green spaces, particularly around the Colne Valley. These would reduce the negative impacts of the scheme, though not necessarily to the extent of bringing its impacts in line with those of the other schemes after mitigation.

10. People Assessment

Introduction

- 10.1** The Commission has considered a range of issues that have impacts on people, for example noise and impacts on the local economy, but the two key Appraisal Modules that consider impacts on people specifically are Quality of Life and Community. The Commission's objectives for these two modules are:
- **to maintain and where possible improve the quality of life for local residents and the wider population;**
 - **to manage and reduce the effects of housing loss on local communities; and**
 - **to reduce or avoid disproportionate impacts on any social group.**
- 10.2** The materials published as part of the national consultation exercise included a review of the community impacts of each scheme, in terms of their consequences for the loss of housing and community facilities. The review also included an equalities screening exercise, which examined the potential for disproportionate or differential impacts upon groups with protected characteristics related to age, gender, religion or belief, disability, ethnicity, sexual orientation, gender reassignment, and pregnancy and maternity.
- 10.3** The Commission's Quality of Life assessment is the first time an integrated Quality of Life analysis has been undertaken with respect to airport development. The Commission initially reviewed the available literature on the impacts of airports on quality of life then conducted a statistical review of two relevant data sets and compared people's self-reported quality of life with how near to an airport people lived or worked or whether they were within an airport's noise contour to see if a statistical relationship could be found. The results of the analysis are not scheme specific and are based on a selection of indicators to describe the relationships between people's quality of life and wellbeing in relation to any airport. This qualitative assessment should therefore be seen as enhancing our understanding of the relevant impacts already set out in this report and in the *Business Case and Sustainability Assessment*, rather than contributing a specific assessment of any individual scheme.

- 10.4** A key theme from respondents to the *Consultation* was that further work should be undertaken on the health and equalities impacts of the schemes. In response to consultation the Commission has reviewed its Health and Equalities analysis, updating and expanding where appropriate. Further details are available in **Annex A** of the Sustainability Assessment and Equalities Impacts Report.

Assessment

Housing and amenity loss

- 10.5** All of the three schemes would result in a loss of homes in the local community due to the land take required to construct the expanded airport, as set out in the Place module. These impacts would be largest for the Heathrow Airport Northwest Runway scheme, which would require the loss of 783 homes, including the entire community of Longford and much of Harmondsworth. The loss of housing required for the other two schemes would be smaller, though still significant, with 242 houses estimated to be lost as a result of the Heathrow Airport Extended Northern Runway scheme's land-take and 167 lost due to the Gatwick Airport Second Runway scheme.
- 10.6** The Gatwick scheme is in a relatively sparsely populated area much of which has already been safeguarded for development, while the area around Heathrow is more densely populated leading to more homes being affected. The smaller footprint of the Extended Northern Runway scheme leads to its reduced impact on housing loss compared to the Northwest Runway scheme. In addition all three schemes lead to community facilities being lost, for instance a Hindu temple in the vicinity of Gatwick and Harmondsworth Primary School as part of the Northwest Runway scheme.
- 10.7** Surface access works associated with each scheme would also require some housing loss, although the scale of these impacts would depend heavily on the detailed route and construction design for any surface access interventions required and any mitigations adopted, such as the introduction of an access or congestion charge for road vehicles. Any housing loss of this kind would be expected to be significantly smaller for the Gatwick scheme than for the two Heathrow schemes, given the less extensive surface access works required, and higher for the Northwest Runway than for the Extended Northern Runway.

- 10.8** A large number of consultation responses highlighted concerns regarding the level of housing loss associated with the shortlisted schemes and the impact of this on local communities. The Commission is acutely aware of the significance of this issue for local communities and the importance of ensuring that steps are taken to compensate those affected and mitigate the impacts of property loss to wider communities, as far as possible for example by ensuring that the airport pays an appropriate level of compensation and contributes to sustainable development, including new housing, in the area. The Commission's recommendations in this area are set out in **Chapter 14**.
- 10.9** Both Gatwick Airport Ltd and Heathrow Airport Ltd have proposed compensating people who would lose their homes at full unblighted market value plus an additional 25% and reasonable costs. This is significantly above the legal minimum and also exceeds the Government's current offer for HS2. Nevertheless, the Commission recognises that forced moves would be stressful and unwelcome for many and a number of consultation responses stressed the need to ensure people could move to an 'equivalent' property. Both promoters have also proposed to voluntarily purchase properties in a wider area. The proposed Community Engagement Board could play an important role in ensuring that any compensation package is designed to reflect the need and priorities of local communities. The scheme promoters' compensation offers are discussed more detail in **Chapter 14**. These compensation packages would significantly offset some of the community impacts even if, as a number of consultation responses noted, compensation should not be equated with full mitigation.
- 10.10** Work on the impacts of schemes on road freight, carried out in light of consultation responses, has indicated a number of roads in the vicinity of the Heathrow site which may see a noticeable increase in goods vehicle traffic following expansion. Some of the areas affected are residential, so there may be an amenity impact for affected communities

Impacts on groups with protected characteristics

- 10.11** Each development would change the character of the nearby area and therefore have an effect on those living there. The current community profiles around Heathrow and Gatwick are noticeably different. The population around Heathrow is younger and more ethnically diverse than the national average, whereas the population at Gatwick is older and less diverse than at Heathrow. The religious makeup of the areas is also noticeably different across different wards around the airports. This suggests that the equalities impacts of the schemes are likely to differ. The possible impacts from community disruption on groups of people with

protected characteristics, such as people who are religious, or BAME people, would need to be considered as part of detailed design and through the development of any mitigation measures. At Heathrow, analysis suggests that the unmitigated loss of certain types of community facilities could have particular impacts on older people, younger people, those with disabilities and those who are pregnant or recent mothers, if no adequate alternative facilities were provided. However, it is likely that good mitigation of these impacts can be provided, through appropriate re-provision of these facilities.

10.12 It should be noted, however, that impacts on people around the airport, including those with protected characteristics, will not all be negative. There could be a positive impact on social inclusion, as new jobs associated with expansion could support increased employment in local areas. These impacts would be particularly valuable in the area around Heathrow, which has higher levels of unemployment than around Gatwick. Employment generated through expansion could also be beneficial for the communities around Heathrow, 33% of whose workforce in 2013 was from non-white ethnic backgrounds,⁷⁴ compared to a national average of 14.5%.⁷⁵

10.13 More detailed work would be required to evaluate these impacts during the planning and detailed design stages. However, on the basis of the available evidence, it is anticipated that mitigation measures would be able substantially to reduce the negative impacts.

Quality of Life and the Appraisal Framework

10.14 When the Commission reviewed the available literature on quality of life impacts, various possible impacts were found across the Commission's assessment modules, with some positives, such as the economic and connectivity benefits, as well as more negative impacts of noise or carbon.

74 Heathrow Employment Surrey 2013, IPSOS MORI

75 ONS Labour Market Statistics, April 2015

Table 10.1: Possible airport impact factors by geographical range and individual impact

Impact area	Possible impact factors	Individual impact
Local – within 5km	Local Economy Impacts (jobs)	POSITIVE
	Community	POSITIVE
	Noise	NEGATIVE
	Air Quality	NEGATIVE
	Place	NEGATIVE
	Surface Access	POSITIVE
	Strategic Fit (connectivity)	POSITIVE
Local – outside 5km within flight path	All above	
	Noise	NEGATIVE
National	Economy Impacts	POSITIVE
	Carbon	NEGATIVE
	Strategic Fit (connectivity-business)	POSITIVE
	Strategic Fit (connectivity-leisure)	POSITIVE

Source: Airports Commission analysis

Local statistical analysis

10.15 The Commission's statistical analysis suggests that at a local level:

- Living near an airport (within 5km) has no aggregate statistical impact on subjective wellbeing measures. The reasons for this cannot be ascertained definitively: it may be because within the broader community the positive effects (for instance availability of jobs and airport associated surface transport improvements) and the negative impacts (noise, congestion, urbanisation) cancel each other out, or alternatively it may be that there simply is not a strong relationship between being near an airport and these indicators. Proximity to an airport does not necessarily imply being within a noise contour.
- Being near an airport does not have an effect on happiness in the moment, but is negatively associated with feeling relaxed. The negative effect is larger for people who are working or studying at that time.

- Being at an airport (and not working there) is positively associated with happiness and, at the same time, negatively associated with feeling relaxed: airports are associated with happiness and excitement, but can also be stressful experiences. This is in line with findings in the literature review of the impacts of holidays, where people report a positive impact on mood when on a relaxing holiday abroad.
- Living in a daytime aircraft noise contour (over 55 decibels) is negatively associated with all subjective wellbeing measures: life satisfaction, sense of “worthwhile”, happiness, levels of anxiety and positive affect balance, with the negative effect of daytime aircraft noise being greater for people living in social housing.⁷⁶ To provide a sense of scale, the negative effect of aircraft noise on peoples’ sense of “worthwhile” is around half that associated with being a smoker, and less than a third that of being underemployed.⁷⁷ The negative effect of aircraft noise on peoples’ happiness is less than half that of being divorced and less than the negative effect associated with living in social housing.⁷⁸
- Living in a nighttime aircraft noise contour was not associated with any aggregate statistical effect on subjective wellbeing.
- Being in a high level aircraft noise contour was negatively associated with happiness and feeling relaxed at that time.

Wider statistical analysis

10.16 A consistent finding in the wellbeing literature is that employment is positively associated with a number of measures of subjective wellbeing, including life satisfaction. Although the wellbeing effect of the job will be internalised in wages to some degree, the available evidence suggests a residual effect of employment on wellbeing even after controlling for income. The analysis found no statistical difference between jobs based in airports and those based outside airports with respect to measures of happiness and relaxation. The assumption, therefore, is that the value of employment estimated for the general population (which will include some people that work in airports) is applicable to jobs created as part of airport development.

76 PwC’s analysis also confirmed this result is not driven by the possibility that more social housing is located near to airports

77 Being underemployed can include those who are unemployed, involuntarily in part-time work (i.e. those who work part-time but wish to or could work full-time) and those who are overqualified or underutilised in their current positions

78 Airports Commission, *Quality of Life: Assessment*

10.17 There is also a benefit to people nationally (as well as locally) through the leisure impacts of the resulting increased connectivity, which could increase access to leisure holidays or visits to see family and friends by increasing the availability of flights to different places, reducing the cost of travel and improving the passenger experience. The Commission's analysis showed statistically significant positive effects of leisure abroad improving mental and physical health, as well as boosting productivity. The general results of the statistical analysis across all of the datasets is that taking holidays and flights is associated with improvements in health and wellbeing. The only differential impact between socio-demographic groups (e.g. age, income) is that the positive association between having holidays and self-reported general health and depression is stronger for unemployed people than for employed people.

Health

10.18 Several of the Commission's appraisal modules consider factors that can impact people's health. Negative air quality and noise impacts were most often highlighted in consultation responses in relation to concerns about effects on health, along with possible negative impacts on people's wellbeing of changes in their community or their engagement with nearby landscapes. However there are also positive impacts, for instance through the positive wellbeing and overall health impacts of having employment and through improvement in people's ability to access the services, facilities and products they need to live healthily.

10.19 Negative impacts on health can be reduced through mitigation. For example, the Heathrow schemes include a number of proposed mitigations, both through reducing the initial impact (for instance providing respite from noise through operational design) or by providing other forms of compensation that can support people's health and wellbeing, such as the large green space provided as part of the Northwest Runway scheme that would be available as a public space in which to exercise and be active.

10.20 At this stage of design determining the precise health impacts is challenging, but work that could be useful when more detailed designs are developed in preparation for planning consent is set out in the Health Annex of the *Sustainability Assessment*. In particular, it would be important to engage with local communities as part of the design process to more fully understand the health issues affecting them, and a scoping exercise would need to be carried out to ensure that not only is statistical information taken into account, but also the key concerns of local people. Any such scoping exercise should be carried out alongside a full Health Impacts Assessment.

Performance against objectives

- 10.21** The overall impact on quality of life is likely to balance the positive benefits of increased employment and greater leisure travel against negative impacts such as noise. At the aggregate level reflected in the statistical analysis, the impact of expansion is therefore assessed as broadly neutral even if the impacts on individuals may well be strongly positive or negative. But the impacts assessed in other areas of the Commission's appraisal such as Place, Community and Air Quality could also have potential to affect people's wellbeing and the relative performance of the different schemes with respect to these modules is set out in the relevant sections. Adding these results into the Commission's assessment of the schemes performance against its objective **to maintain and where possible improve the quality of life for local residents and the wider population** could risk double counting and the Commission has therefore not identified different performance levels between the schemes on this objective.
- 10.22** In terms of the objective **to manage and reduce the effects of housing loss on local communities** it is clear that the Gatwick Second Runway and Heathrow Extended Northern Runway schemes have lesser impacts than the Heathrow Northwest Runway scheme. The compensation offer put forward by Heathrow Airport Ltd provides a starting point for offsetting these effects, and the Commission's recommendations in relation to compensation are set out in **Chapter 14**, but as a number of consultation responses noted, compensation cannot be equated with full mitigation. The final impacts on community cohesion around the sites will be dependent on careful ongoing design and engagement with the local community by the scheme promoter.
- 10.23** In terms of the objective **to reduce or avoid disproportionate impacts on any social group**, the final impacts on community cohesion for each scheme are difficult to judge at this stage, because the nature and scale of these will depend heavily on detailed design work. With the information currently available, it would therefore not be appropriate to compare the differing scale of these impacts between schemes. It is, however, expected that negative impacts would be susceptible to mitigation.

11. Commercial Viability and Delivery Assessment

Introduction

11.1 The Commission's terms of reference required it to take account of the commercial and technical viability of each scheme, which are central to its overall deliverability.

11.2 The assessment of commercial viability drew together work on the costs, affordability and financing risks associated with each scheme, to consider their performance against the following objective for the scheme:

- **to be affordable and financeable, including any public expenditure that may be required, and taking account of the needs of airport users.**

11.3 The work on technical viability was conducted as part of the Delivery appraisal module and identified and reviewed any significant risks associated with each of the three shortlisted schemes and the extent to which those risks might be mitigated. It drew on the findings of the other modules within the Commission's *Appraisal Framework* to consider factors such as construction risk, housing loss and surface access requirements and qualitatively assess performance against the following objectives:

- **to have the equivalent overall capacity of one new runway operational by 2030; and**
- **to actively engage local groups in scheme progression, design and management.**

Commercial viability

Methodology

11.4 The Commission considered three main areas in making its assessment of the cost and commercial viability of each scheme:

- i) The costs** including the scheme capital expenditure, the additional costs of operating and maintaining the airport infrastructure and any costs outside the boundary of the airport that may require public expenditure, such as surface

access costs or additional compensation arrangements. Following consultation, the costs have been reviewed and where necessary amended.

The cost estimates contain allowances for risk and optimism bias.⁷⁹ The approach and resulting allowances have also been reviewed as a result of consultation. Further details of this review and amendments made are provided in the Commercial Case.⁸⁰

- ii) The commercial viability of the scheme**, which involved an assessment of the affordability and understanding both of the costs and the willingness of airport users to pay the charges required to support these costs. As the financial model used is based on the whole airport operation and the finances of the airport corporate entity, these new charges therefore need to reflect not only the capital costs of the scheme but also the operational, maintenance and financing costs of the entire airport operation.

The approach used to model commercial viability assumes that the airport will finance expenditure on the scheme by raising debt and equity. Increased charges to the airlines to use the runway and other additional revenues such as greater car park usage by the additional passengers are assumed to service these investments and provide returns to investors. In response to consultation the conclusions have been tested through a range of different sensitivities and scenarios, the full range of which are set out in the Commercial Case.

The assessment of commercial viability also includes consideration of public expenditure and airport user implications. For example, the impact of including or excluding the cost of scheme related surface access enhancements is considered, and this may require some degree of public expenditure, subject to State Aid considerations. It is expected that the airport operator would contribute some or all of these costs. It is also assumed that the surface access enhancements required to deal with background demand on the transport networks already exist. The Commission has also included the costs

79 Risk reflects the observation that there is always likely to be some difference between what is expected and what actually materialises. Appraisers calculate an expected value for the different risks (e.g. ground conditions and excessive variation) for a particular option and consider how exposed each option is to future uncertainty. In addition, optimism bias is the demonstrated, systematic, tendency for project estimates to be overly optimistic. This is a worldwide phenomenon that affects both private and public sectors. Parameters affected by optimism include the tendency to overstate benefits and understate timings and costs, both capital and operational. To redress this tendency, appraisers (in this case the Commission) have made an explicit adjustment to allow for this bias.

80 Part of the *Business Case and Sustainability Assessment* published alongside this Final Report.

of the compensation and mitigation measures suggested by each promoter as well as sensitivities of 10% additional capital cost for further as yet unspecified costs such as additional compensation regimes. Such costs could include some of the recommendations made in **Chapter 14**.

While this approach provides a reasonable basis for the purposes of the Commission's analysis, it is not the only option for funding and financing the schemes. The optimal approach will be developed by the airport and other relevant stakeholders as the recommendations of the Commission are acted upon and may well take a different form.

iii) The financeability of the scheme, including the key risks for financing and the options available for mitigating these with possible roles for the airport owner, the Government and other parties.

11.5 The Commission used a variety of scenarios to test the scope of the different futures envisaged. This included a number of different demand scenarios as well as sensitivities around different parameters including the cost of finance (both debt and equity), timing of economic regulatory agreements and aero charge changes (these allowing consideration of the impacts of pre-funding and suggestions from consultation responses) and public expenditure sensitivities (for example the funding of surface access costs).⁸¹ The baseline carbon-capped *assessment of need* results are presented in this chapter. Given the lower number of passengers in the carbon-capped scenario these results represent a more pessimistic evaluation of the cost implications, as the total costs are shared amongst fewer passengers.

Assessment

Comparison of costs between the three schemes

11.6 Following review, the costs other than for the Heathrow Airport Extended Northern Runway Scheme are now estimated to be lower than those published for consultation in November. Both the base (and unadjusted input) costs and the allowance for risk and optimism bias have been reduced. However, this has not changed the relative scale of costs with the total costs of the two Heathrow schemes remaining significantly greater than those of the Gatwick scheme.

81 Details of the output of this financial analysis are given in the technical reports *Cost and Commercial Viability: Funding and financing update*, and *Cost and Commercial Viability: Additional Sensitivities*.

Table 11.1: Airports Commission cost estimates, carbon-capped, £ billion, 2014 prices

	Heathrow Northwest Runway	Heathrow Extended Northern Runway	Gatwick Second Runway
Scheme costs			
Scheme capital expenditure, base costs	£12.8	£10.5	£5.1
Risk	£2.6	£2.1	£1.1
OB	£2.2	£1.8	£0.9
Total scheme capital expenditure	£17.6	£14.4	£7.1

11.7 In addition to these scheme costs the financial modelling has also taken account of a range of other costs that the airport as a corporate body would need to consider when raising finance. **Table 11.2** below shows these overall costs.

Table 11.2: Airports Commission overall cost estimates, carbon-capped, £ billion, 2014 prices⁸²

	Heathrow Northwest Runway	Heathrow Extended Northern Runway	Gatwick Second Runway
Scheme capital expenditure	£17.6	£14.4	£7.1
Core capital expenditure	£13.4	£13.4	£3.1
Asset replacement	£16.5	£16.3	£4.2
Operating expenditure	£49.9	£49.6	£14.4
Surface access costs	£5.0	£5.5	£0.8

11.8 The capital costs of each scheme incorporate a wide variety of different elements from runway and terminal expenditure to ancillary facilities, equipment and land. A breakdown of the capital costs for each scheme is given in the report *Cost and Commercial Viability: Financial Modelling Input Costs Update*. As an example from this report, **Figure 11.1** provides a breakdown of the capital costs for the Heathrow Northwest Runway scheme.

⁸² Core Capital Expenditure: capital expenditure planned in any case (i.e. irrespective of whether the scheme is developed), Asset Replacement: capital upgrade and maintenance of the airport as it develops assuming including existing and new infrastructure. Operating Expenditure: Operational expenditure for the ongoing and future operations of the airport. Surface Access Costs: Total incremental road and rail costs required to facilitate the scheme including capital and operational costs.

Figure 11.1: Breakdown of total scheme capital expenditure for the Heathrow Northwest Runway scheme, carbon-capped, assessment of need, £ million, 2014 prices⁸³

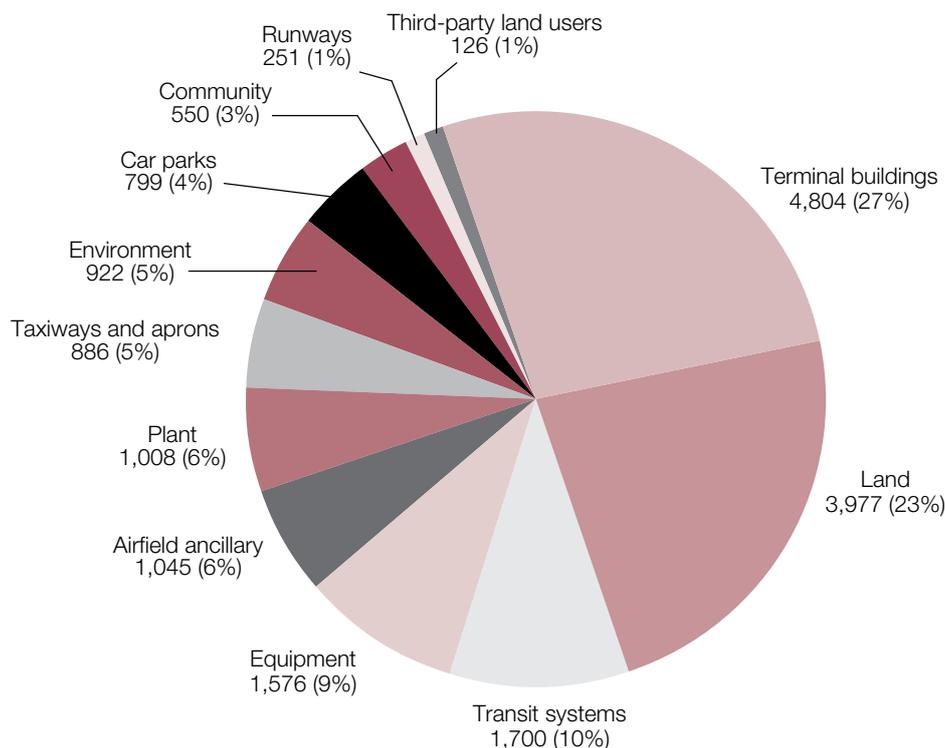

Source: Airports Commission analysis

- 11.9** For all short-listed schemes, terminal buildings and land are the most significant cost items, representing up to a half of scheme capital expenditure. In the case of Heathrow Airport Ltd's proposal, terminal buildings reflect the airport's aim to build an airport designed to focus on a traditional hub operation with the provision of expensive facilities such as automated baggage handling systems that minimise check in and transfer time. The higher costs of land around Heathrow are also significant contributors to overall costs.
- 11.10** In comparison, the Gatwick Second Runway scheme has more of a low-cost focus based on a larger proportion of passengers making their own transfer arrangements and a less spacious terminal building than at Heathrow (the equivalent terminal costs at Gatwick are £2.9 billion for the full scheme). Land costs are also lower for the Gatwick Airport Second Runway scheme.
- 11.11** Although the terminal costs of the Heathrow Extended Northern Runway of £4.8 billion are very similar to the Heathrow Northwest Runway scheme, the layout of this

⁸³ This breakdown does not include additional community compensation proposals suggested by Heathrow Airports Ltd in their consultation response. These have been modelled as a separate sensitivity (see *Cost and Commercial Viability: Additional Analysis* report).

proposal has significantly lower land cost at £1.7 billion. This difference of £2.3 billion compared with the Northwest Runway is the key driver behind the £3.2 billion cost differential between these two schemes.

11.12 In response to consultation the Commission has undertaken further analysis to understand the potential for cost reductions. While the scale of the costs for the two Heathrow schemes would remain higher, there would be greater potential to deliver savings through cost reductions for these two schemes than for the Gatwick scheme, although this could entail a trade-off with the passenger experience. This is shown in Table 11.3.

Table 11.3: Scheme capital expenditure scope reduction savings – Airports Commission cost estimates, carbon-capped, £ billion, 2014 prices⁸⁴

Scope reduction savings	Heathrow Northwest Runway	Heathrow Extended Northern Runway	Gatwick Second Runway
Scheme costs			
Total scheme capital expenditure	£17.64	£14.43	£7.06
<i>Scheme capex potential scope reduction savings, base costs</i>	£1.70	£1.07	£0.14
<i>Optimism bias and Risk</i>	£0.65	£0.41	£0.05
Total scheme capital expenditure (after scope reduction savings)	£15.29	£12.95	£6.87

11.13 It should be noted, however, that while the Commission has carried out a consistent and rigorous process to identify costs for each of the schemes to enable a fair comparison to be made, the final design and hence cost for each scheme would be identified through more detailed design at a later stage in the project's development and informed by a process of constructive engagement between the airport and its airline customers as required by the regulatory system.

The commercial viability of the three schemes

11.14 Airports in the UK are generally owned and operated by the private sector so the Commission has based its analysis on the general presumption that any investment will be for the private sector to make. A scheme would therefore be commercially

84 The methodology and assumptions behind this analysis are presented in *Cost and Commercial Viability: Reduced Scope Scenarios Costs*.

viable (or affordable) when the investment and its associated financing costs are matched by future revenue streams.

11.15 For all short-listed schemes the costs are large and entail a transformation of the scale of operation of the airport, when compared to the costs of operating and maintaining the existing airport infrastructure. As the approach adopted has been to consider the commercial and financing implications of the existing airport operator developing their proposed scheme (or in the case of the Extended Northern Runway, Heathrow Airport Ltd developing this scheme), the analysis assessed the impact on airport users as well as the financeability of the different proposals and this is summarised in Table 11.4 below:

- Impact on airport users – the level of the aero charges that would need to be levied per passenger reflects a number of variables including the scheme costs and the demand forecasts (i.e. the number of passengers sharing this and other costs). How the aero charge develops over time is similarly a reflection of a number of parameters such as the regulatory environment, and so the Commission has considered a weighted average aero charge in its assessment;
- Financeability – the scheme capital costs are paid for by the airport as incurred through raising both debt and equity finance. This finance is then serviced through subsequent revenues and refinancing by the airport operator. In this context, the peak levels of debt and equity required are key outputs of the analysis, which have been subject to further scrutiny by investors, lenders and other market participants as part of the assessment.

Table 11.4: Airports Commission commercial analysis, carbon-capped, 2014 prices⁸⁵

Scheme	Weighted average aero charge (current) 2014 prices	Peak equity (current) nominal £billion	Peak debt (current) nominal £billion
Gatwick Second Runway	£16 (£9)	£2.7 (£0.3)	£11.5 (£1.6)
Heathrow Extended Northern Runway	£28 (£20)	£7.3 (£2.7)	£30.4 (£11.7)
Heathrow Northwest Runway	£29 (£20)	£8.2 (£2.7)	£33.8 (£11.7)

85 Other scenarios and sensitivities are available at *Cost and Commercial Viability: Funding and Financing update*; and *Cost and Commercial Viability: Additional sensitivities*.

- 11.16** The commercial viability of the three schemes is based on the ability of the airport users to bear the additional costs (weighted average aero charge figures above in Table 11.4) and the ability of the airport operator to raise and service the additional finance (peak equity and peak debt figure).
- 11.17** In considering the ability of the airport users to bear the costs, analysis undertaken by the Commission suggests that all of the three shortlisted schemes are commercially viable propositions, without a requirement for direct government support. This remains the case even in a situation where the airport is required to fund 100% of the surface access costs, which would not increase the weighted average aero charge by more than two pounds for any scheme (the Commercial Case and the report *Cost and Commercial Viability: Sources of finance* discuss this in more detail).
- 11.18** The risk that the expected passenger demand does not materialise in the future, is considered to be slightly lower for the Heathrow-based schemes (see the section on financeability below).

The financeability of the three schemes

- 11.19** For either of the Heathrow schemes the scale of debt and equity estimated to be required is substantial and could put Heathrow Airport Ltd beyond any existing comparators for investment in UK based regulated companies.
- 11.20** The total size of investment grade bonds issued by companies based in the UK (UK corporates) in 2013 was c. £46 billion. According to the Commission's approach the highest debt funding requirement in any single year for the Heathrow Airport Northwest Runway scheme would be around £6 billion, or 13% of total bond issuances in 2013. This is much larger than the biggest individual bond issuance for 2013 of £3.5 billion by Vodafone. However, market testing suggests that, assuming political support for the project and a stable regulatory environment, providers of both debt and equity consider Heathrow to be a high quality asset and there is appetite to invest under normal financial market conditions. These issues are discussed in more detail in the report, *Cost and Commercial Viability: Funding and Financing Update*.
- 11.21** In addition to market capacity considerations, the aero charges that would be needed to support this investment would put both Heathrow schemes at the top end of the range of charges currently charged by airports around the world. On the other hand, these aero charges do not, under this analysis, reach a level that would deter legacy airlines from operating at the airport. Some low-cost carriers may find the charges harder to meet given their business models, although easyJet's

response to consultation has indicated that there would be an appetite to operate from an expanded Heathrow Airport even allowing for these increases. The aero charge remains a relatively small percentage of the ticket cost and, once competition is taken into account, may in practice be absorbed by airlines rather than passed on to passengers.

- 11.22** At Gatwick Airport the scale of the required investment is significantly lower, and so the scale of additional debt and equity required is lower. Similarly, while the increase in aero charges is high the weighted average does not reach the levels seen at Heathrow, and the evidence does not suggest they could not be met by the low-cost carriers that currently serve Gatwick. However, the demand figures that drive these costs and their associated financing requirements are much more varied for Gatwick.
- 11.23** Where the two Heathrow-based schemes see their weighted average charge vary by around 6% across the demand forecast scenarios examined, at Gatwick the range is between £15 and £18, a 17% difference. Since Gatwick is considered to have more direct competitors for its short-haul low-cost service provision there is a perceived higher demand risk for this scheme. Market-testing suggests, however, that this risk is not considered to be unmanageable and that the schemes are all commercially viable.
- 11.24** Another key determinant of the ability to raise finance is the nature of any economic regulatory arrangement and the analysis demonstrates the current framework is supportive. Although the future regulatory approach has yet to be determined, an alternative option has been presented in Gatwick Airport Ltd's consultation response (which proposed a contract with government). The details of this would be a matter for subsequent negotiation between the Government, the airport and the regulator. The Commission's judgement is that the contract does not significantly alter its assessment of the commercial viability of the Gatwick Airport Second Runway scheme.
- 11.25** Although not believed to be necessary under current market conditions for either scheme, the government may wish to consider additional sources of liquidity should raising finance become more challenging. Current options that could be considered would be the European Investment Bank, or something similar to the current UK Guarantee Scheme (UKGS) which is scheduled to close in December 2016. Both sources would require active engagement by both government and the entity looking to raise finance.

Conclusion

- 11.26** The three short listed schemes represent transformational changes to the current operations of the two airports. It is therefore unsurprising that the scale of the costs required to finance the three schemes is also large and transforms the nature of the current financing. The costs for the two Heathrow schemes would be substantially higher than those of the Gatwick Runway scheme owing particularly to much higher land costs and terminal building construction, baggage handling, passenger transfer and maintenance costs.
- 11.27** For the scheme costs **to be affordable** (i.e. there are sufficient funds to pay for the expenditure), the proposal needs to be commercially viable. Commercial viability has been assessed by considering the business case for each airport operator in the event that it were to develop the short listed scheme. This analysis then looks at the implications this expansion would have on aero charges faced by airport users as well as the ability to raise finance to support the development of the proposal (the financeability test). Consideration in this assessment has also been given to the extent to which the airport operator would look to contribute to costs outside the scheme, or the extent to which public expenditure may be required.
- 11.28** The conclusion of this analysis is that all three schemes are considered to be both **commercially viable and financeable**, with each subject to different risks and opportunities. **Any public expenditure that may be required and the needs of airport users** have been assessed and the analysis of affordability and financeability does not change materially even when the full cost of the surface access enhancements is assumed to fall to the private sector.
- 11.29** Demand risk at Gatwick is considered to be higher than at Heathrow given competition and available capacity from other low cost airports in the London system. Aero charges and the scale of financing for the Heathrow-based schemes would be beyond current global comparators, but it is considered that this scale of financing is deliverable. The demand risk associated with the Gatwick scheme is considered by the investor community to be marginally more significant than the market capacity risk for the Heathrow schemes. But neither risk is seen as preventing any scheme from being commercially viable. The impact of these factors on the deliverability of the scheme is discussed further in the Delivery section below.
- 11.30** Finally, it is recognised that this feedback from market participants is caveated with the difficulties in assessing financial markets a number of years in advance of the need to raise finance and that there will be a need for active management of the scale and timings of financing in delivering the additional runway capacity.

Delivery

Methodology

11.31 The Commission has built on the airport masterplans described in **Chapter 5** to assess the overall level of risk associated with each scheme in terms of planning, financing, construction, public deliverability and resilience to legal challenge, as well as reviewing how these risks might be mitigated and how the transitional steps towards delivery of the new infrastructure might be managed. This has allowed an analysis of each scheme against the two delivery objectives set out at paragraph 11.2 above and discussed in detail below.

Assessment: To have the equivalent overall capacity of one new runway operational by 2030

11.32 At the point of consultation, the Commission's analysis indicated that the Gatwick scheme could be delivered by 2025, while the two Heathrow schemes could be delivered by 2026.

11.33 A number of consultation responses sought to challenge these assumptions, but a review of the arguments made did not uncover any grounds to overturn the dates published for consultation. It must be accepted that a number of factors, such as potential delays to, or acceleration of, the planning and legal processes might impact the dates at which a new runway would come into operation. However, these factors apply equally to all three schemes and the estimated delivery dates remain plausible. So there is substantial flexibility to manage unforeseen risks to delivery timetables whilst still achieving an opening date before 2030 in line with the Commission's assessment of need.

Planning risks, including for secondary developments

11.34 Airport expansion of this type and scale has not been successfully undertaken in the UK for many years. Recent changes to the legal and planning framework, including the Planning Act 2008 (as amended by the Localism Act 2011) have reformed planning processes for nationally strategic infrastructure projects and introduced the concept of National Policy Statements. Hybrid Bills, which provide an alternative means to securing planning permission for major projects, have historically been relatively uncommon, although the Government has growing experience of this procedure through the Crossrail and Channel Tunnel Rail Link Acts and the ongoing Parliamentary process to secure powers for the first phase of HS2.

- 11.35** The Northwest Runway scheme would require the removal and replacement of the Lakeside Energy from Waste Plant. The plant, while not of national importance, nevertheless plays a significant role in regional and local waste management and has a valuable capability to process clinical waste and other contaminated material. Its replacement is necessary. The planning and construction of an Energy from Waste Plant would be a substantial exercise in its own right, whose timescales are not substantially shorter than the delivery of new runway infrastructure. The process of planning a provision of an alternative facility should begin as soon as possible. The scheme promoter has begun a process of engagement with the owners of the plant with a view to identifying potential replacement sites. Neither of the other schemes has a similar interaction with an infrastructure asset of this scale.
- 11.36** All three schemes rely for their surface access upon a number of road and rail links which are already highly congested (see surface access **Chapter 8**). Although the Commission's analysis demonstrates sufficient capacity to accommodate airport expansion by 2030, it is expected that demand pressures will continue to grow past that point, creating tensions between the allocation of capacity to serve airport users and the provision of commuter services. Government will need to ensure that its longer term planning makes provision for this increase in background demand.
- 11.37** All three schemes require the demolition of residential property, to accommodate the expanded airfield site and potentially also to deliver its associated surface access links, although the latter would depend on detailed route and construction design and any mitigations taken forward.
- 11.38** The housing loss associated with the Northwest Runway scheme is significantly higher than that associated with the other two schemes. The airfield expansion is estimated at 783 residential properties lost, compared to 242 for the Extended Northern Runway scheme and 167 for the Gatwick scheme. The scheme developer would need to purchase these properties either by mutual agreement or by the terms of a Compulsory Purchase Order (CPO). Both Heathrow Airport Ltd and Gatwick Airport Ltd have proposed to purchase properties for their full unblighted market value plus an additional 25% plus reasonable costs.

Construction risks

- 11.39** Although large scale and complex projects, the level of construction risk associated with each scheme is not unprecedented. The schemes reflect well known and understood engineering principles and the Commission saw no reason to doubt that they could be delivered within the timescales identified. The Heathrow schemes, which require the M25 to be placed in a tunnel, are slightly more

challenging construction projects, which is reflected in the delivery timescales, but there are still ample precedents for projects of that nature and scale.

Regulatory challenges

- 11.40** All three schemes are dependent upon the delivery of the Future Airspace Strategy and the London Airspace Management Programme. These would deliver an important modernisation of the UK's airspace structures, necessary to accommodate demand growth with or without airport expansion. The importance of delivering these programmes is discussed further in **Chapter 16**, but delivery of these programmes has been controversial so far, with airspace trials at Heathrow and Gatwick during 2014 attracting a significant number of complaints. The trials were based on an extreme form of concentration. Other approaches are possible and may need to be tested. The lack of runway alternation to provide respite for affected communities under the Gatwick Airport Second Runway scheme may render the process of airspace design particularly contentious.
- 11.41** For the Heathrow Northwest Runway scheme, advice from NATS has identified a high likelihood that the new runway would have significant operational impacts on RAF Northolt, a military airfield located six miles north of Heathrow, which also accommodates a number of civilian business and general aviation movements. While the scheme would not require the end of military movements at Northolt, there is a significant risk that it might not be possible to continue to operate civilian flights from it without some impact on the capacity of the scheme (potentially on a one-for-one basis, reducing capacity by up to 7,000 ATMs).
- 11.42** There is no direct precedent for the in-line runway proposal that forms part of the Heathrow Extended Northern Runway scheme, although partial precedents can be found in diagonally-offset end-to-end runways, for instance at Madrid. On the basis of the available evidence, the Commission's view is that the proposed runway infrastructure could be operated in a safe manner. Confirming this finding, however, is likely to require years of work with both UK and international safety regulators. The processes involved are potentially protracted and would need to begin early in the implementation stage of the project if the estimated completion date of 2026 were not to be jeopardised. The scheme promoter has made a useful start to this process, but much of the necessary work could only be undertaken at a more detailed stage of development.

Commercial risk

- 11.43** The commercial viability of the Gatwick Second Runway scheme is to some extent sensitive to global trends in the aviation sector. With low-cost carriers forming a significant share of Gatwick's current customer-base, an increase in aero charges could result in adverse impacts on the airport's utilisation. Other aspects are likely to mitigate the commercial risks involved, for example the lower overall costs and the proposed phased approach to delivering the additional capacity. Based on its analysis, the Commission considers that the scheme is commercially viable, is unlikely to require Government support and that the scale of commercial risk is manageable.
- 11.44** While the scale of the investment required to deliver the Heathrow-based schemes is greater and the estimated aero charges are significantly higher, work to date has demonstrated that both the size and strength of the local passenger market and the airport's wider position within the global aviation sector means that the proposition is likely to be less sensitive to demand risk.

Assessment: To actively engage local groups in scheme progression, design and management

- 11.45** The Commission did not require scheme promoters to consult during the Commission's process, but rather to demonstrate a capacity to engage appropriately and effectively with local stakeholders and the public during and after the delivery of additional capacity.

Gatwick Airport Second Runway scheme

- 11.46** Gatwick Airport Ltd has undertaken a programme of engagement during the Commission's process, providing an opportunity for stakeholders and the public to express their views on the design of the proposals, highlight their major concerns and influence the airport's compensation and mitigation package. This engagement was centred on its consultation *Gatwick Runway Options*. The consultation explored three options for an additional runway at the airport and ran for six weeks in April and May 2014.
- 11.47** During the consultation Gatwick Airport Ltd held 17 well attended public exhibitions, mailed a newsletter to 180,000 homes, advertised across local print and broadcast media, and wrote an explanatory letter to all homes and businesses within the 57L_{Aeq} noise contour. It has made clear in its submission to the Commission's consultation that it recognises that further local engagement will be required during the planning process, whichever approach to securing powers is adopted by the

Government, and has explicitly undertaken to consult on the details of its proposed compensation scheme for local communities.

Heathrow Airport Northwest Runway scheme

11.48 The Commission has noted that Heathrow Airport Ltd has undertaken a programme of engagement focused on providing an opportunity for the public to express their views on the design of the proposal and to indicate preferences and priorities for the airport's compensation and mitigation package. This engagement activity influenced the refreshed scheme design sent to the Commission in May 2014 and has also led to iterative but significant improvements to the compensation and mitigation package proposed by the airport. Heathrow Airport Ltd chose to run two consultations following the Commission's *Interim Report*, one primarily on design and the other primarily on compensation.

Heathrow Airport Extended Northern Runway scheme

11.49 Heathrow Hub Ltd did not run as extensive a programme of engagement as the other scheme promoters, reflecting the more limited resources available to it. However, it did demonstrate a clear willingness to engage and an awareness of the importance of engagement with local communities. During the Commission's process Heathrow Hub Ltd ran an exhibition roadshow in nine locations around Heathrow and attended 28 community meetings to provide local communities with an opportunity to both understand the proposal and to provide feedback. Each roadshow was promoted through print media advertisements and notification to local authorities and the display materials were professional, clear and informative.

Common issues

11.50 Issues common to all schemes include the challenge of communicating effectively on the complex and subjective issue of aviation noise as well as a lack of clarity associated with changes to airspace. In **Chapter 14** the Commission makes recommendations on how to address this challenge, including re-emphasising its view that the Government should establish an independent aviation noise authority to act as an impartial source of expertise and advice on noise; and recommending the establishment of new Community Engagement Board to ensure a more collaborative relationship between the airport and its local communities.

Conclusion

- 11.51** In relation to the objective **to have the equivalent overall capacity of one new runway operational by 2030**, the Commission's assessment is that all of the shortlisted schemes could be delivered to the required timescale, although they still each present significant challenges.
- 11.52** The delivery challenges associated with expansion at Heathrow Airport, largely as a result of the need to remodel the M25 and, for the Northwest Runway scheme, move the nearby energy from waste plant, are greater than at Gatwick Airport but are not considered unusual for an infrastructure project of this scale. In operational terms, the Northwest Runway scheme is not complex or novel and Heathrow Airport Ltd has a track record in major project delivery from Terminal 5 and the more recent redevelopment of Terminal 2.
- 11.53** While the Extended Northern Runway scheme has some advantages in terms of delivery, particularly the fact that it does not require the relocation of the energy from waste plant, this is counter-balanced by the innovative nature of the runway proposal. On balance, the Commission does not consider that the delivery risks are substantially different between the two Heathrow schemes.
- 11.54** The Gatwick scheme is subject to fewer delivery risks than either of the two Heathrow schemes, although it is still not without challenges, notably those arising from airspace design. However, there are no grounds to believe that the scale of the risks associated with the Heathrow schemes are such that they would fundamentally affect the level of confidence that either scheme was deliverable.
- 11.55** In respect of the objective **to actively engage local groups in scheme progression, design and management**, the Commission's view is that both Heathrow Airport Ltd and Gatwick Airport Ltd have demonstrated an understanding of the engagement a new runway will require and the competence to manage the complex consultative and engagement programmes this will entail. While on its own Heathrow Hub Ltd has not demonstrated the capacity to undertake the extensive and complex engagement that would be required as an additional runway is taken forward, it is likely that the airport operator would play the lead role as the delivery body for the Extended Northern Runway and, in combination with the experience gained through Heathrow Hub Ltd's engagement to date, would bring the resources and expertise to ensure that the objective would be met.

12. Operational Viability Assessment

Introduction

12.1 The Commission's terms of reference also require it to take into account the operational viability of three short-listed schemes. This operational assessment allows the Commission to have confidence in the level of additional capacity that schemes will provide, once their impacts on the wider airport system have been taken into account. It allows for an understanding of the quality and type of passenger experience that would be provided by each proposed scheme and how that would align with various future business models and development scenarios. It also allows for the testing of the implications of schemes for delay and resilience, both at the expanded airport and across the wider airport and airspace systems; minimising delays has direct benefits for passengers, airlines and the economy as less time and fuel are wasted. These issues were assessed through two modules within the Appraisal Framework: Operational Efficiency (14) and Operational Risk (15).

12.2 The objectives under the Operational Efficiency module are:

- **to ensure individual airport and airports system efficiency;**
- **to build flexibility into scheme designs;**
- **to meet present industry safety and security standards;** and
- **to maintain and where possible enhance current safety performance with a view to future changes and potential improvements in standards.**

12.3 And the objective under the Operational Risk module is:

- **to enhance individual airport and airports system resilience.**

Methodology

12.4 The Operational Efficiency and Risk appraisals can be seen as a counterpart to the Strategic Fit analysis. As the Strategic Fit module examined the benefits that would arise from the shortlisted schemes in terms of connectivity and the resultant airline behaviours, so these modules sought to determine whether the proposed airport infrastructure, and the airspace structures that would need to accompany it, would be capable of supporting the anticipated growth in traffic, including when impacts

on other airports within the UK system are taken into account. These assessments also determine how flexible the schemes are to respond to a range of future scenarios for the airline industry and how schemes would impact upon delays, both at the expanded airport and across the UK's airport system.

- 12.5** Appraisals were based upon the updated scheme designs provided by the promoters in May 2014. These were subjected to an initial round of checks by the Commission's consultants, which led to some minor changes to ground infrastructure and further work on the development of indicative airspace designs.⁸⁶
- 12.6** NATS and LeighFisher provided advice on airspace and airport infrastructure and their implications for the shortlisted schemes. In addition the Civil Aviation Authority (CAA) carried out a Preliminary Safety Review for each scheme. The purpose was to establish that the future airspace could be designed to enable the shortlisted schemes to provide the proposed levels of capacity, the extent of impact on the London and South East system's capacity and resilience, and the operational capability of each airfield's proposed layout and infrastructure.

Assessment

Scheme capacity

- 12.7** The analysis suggests that all three schemes would add significant additional capacity to their respective airport (**Table 12.1**).

Table 12.1: Assessed scheme capacities, air transport movements

Scheme	Do minimum	Expansion	Capacity increase
Gatwick Second Runway	280,000	560,000	280,000
Heathrow Northwest Runway	480,000	740,000	260,000
Heathrow Extended Northern Runway	480,000	700,000	220,000

⁸⁶ Since the analysis began in the summer of 2014 all three scheme promoters have continued to refine their designs. These refinements have not been captured within the Commission's appraisals and are not expected to significantly alter the key appraisal findings. They are nevertheless reflective of the further stages of detailed design that the Commission expects the promoter of the recommended scheme to carry out ahead of seeking planning consent. As with the design of other facilities, the final airspace designs would be the result of an intensive process of detailed design and consultation, which would not complete until much closer to the opening date for any new airport capacity.

- 12.8** A number of responses to consultation questioned the capacity estimates put forward, suggesting that they under or over-estimated the capacity that would be provided.
- 12.9** The Commission asked its technical advisors to review these responses. They noted that it was possible to produce different capacity estimates for each scheme depending upon the assumptions on resilience and respite used. However, the review concluded that the capacity estimates published for consultation represented a plausible view of the capacity of each scheme, based upon a combination of consistent assumptions and the promoters' own plans in relation to respite.
- 12.10** The Gatwick figure is higher than the current 480,000 air transport movement (ATM) limit at the current two-runway Heathrow, reflecting that no runway alternation is proposed and that the fleet mix was likely to skew heavily towards narrow-bodied aircraft, allowing for smaller separations between arriving and departing aircraft.
- 12.11** Of the two Heathrow schemes, the Northwest Runway scheme offers the largest increase in capacity. This is due to lower anticipated congestion on taxiways and also simpler respite procedures associated with that scheme, which would keep all three runways in operation throughout the day, albeit with certain runways only used for arrivals or departures at certain times. The Extended Northern Runway scheme, by contrast, would be more susceptible to taxiway congestion and would not operate all three runways at certain times of the day to provide respite. While, in principle, the highest number of peak-hour movements is not significantly different between the schemes, it would be easier to schedule a larger number of movements over the course of the full operating day with the Northwest Runway scheme.
- 12.12** Fast time simulation, carried out by NATS, was used to test whether airspace structures could support the capacity estimates. This confirmed that while managing the expected increase in traffic that would accompany any of the schemes was likely to be challenging, it should nevertheless be achievable provided airspace structures could be modernised suitably, taking advantage of technological advances. None of the schemes was anticipated to reduce capacity at any other major airport within the UK system, though the Heathrow Northwest Runway scheme is expected to have an impact upon operations at RAF Northolt, potentially to the extent of requiring an end to civilian operations there. The loss of fewer than 10,000 small aircraft movements at RAF Northolt per year is not considered to be significant in terms of overall system capacity. The design of missed approach procedures for the Northwest Runway scheme would potentially be a complicated

exercise, but there is no evidence to suggest that adequate procedures could not be developed using established processes.

- 12.13** The analysis also suggests that the proposed infrastructure associated with all three schemes is capable of supporting a wide range of future fleet mix scenarios.
- 12.14** The infrastructure at Gatwick is particularly optimised for meeting the needs of low-cost carriers, using mostly narrow-bodied jets. The new mid-field piers and stands would provide extremely rapid turn-around times for such operators, with quick access to either runway. The separations between the taxiways would mean that in scenarios where very large Code F aircraft (the Airbus A380 and any successors) became a large part of the fleet mix, some disruption may occur when two or more such aircraft were trying to taxi to the same runway at the same time, but this not expected to have a material impact on operations under all but fringe scenarios.
- 12.15** For both Heathrow schemes, some responses to consultation questioned whether the proposal would be able to meet the needs of low-cost carriers, should these form a significant part of the growth in traffic at Heathrow. Having analysed these responses and taken advice from its consultants, the Commission is content that there are viable solutions for accommodating the needs of low-cost carriers on the site, which could be implemented during the detailed design phase.

Resilience and respite

- 12.16** The results of fast time simulation indicated that it was likely to be generally beneficial to airspace system resilience to have an extra runway available in London and the South East, as overall levels of traffic were forecast to increase with or without airport expansion and an extra runway makes this challenge easier to manage. Airspace management would be easier in respect of the Heathrow schemes, given that they would represent an evolution of a current design which sees Heathrow acting as a centre of gravity within the London and South East system, but the challenges associated with the Gatwick scheme were not believed to be insurmountable.
- 12.17** At Gatwick it should be noted that mixed-mode operations would mean that the airport would not have the option of using tactical desegregation to recover from periods of disruption; an option that Heathrow currently uses as a “safety valve” when delays on arrivals begin to mount up. This could make it more difficult to manage the impact of delays once the airport reaches full capacity, though resilience is still expected to be better than today’s levels.

- 12.18** Under the Heathrow Northwest Runway scheme the promoter has put forward an alternation schedule under which one runway would be used for arrivals, one for departures and one for mixed mode, with the configuration changing to a set schedule to provide respite for communities under the flight paths. While it has not appraised the issue in detail, the Commission has noted that there would remain some scope within this design for the use of tactical desegregation to manage the recovery from periods of disruption, which is a useful tool for the airport at present. It would also be expected, however, that the addition of new capacity would reduce the need for such desegregation, which causes significant annoyance to noise-affected communities.
- 12.19** For the Heathrow Extended Northern Runway scheme the promoter has suggested a runway alternation mechanism that would be used to provide respite, although the Commission's analysis indicates that maintaining the resilience of the airport's operations is likely to require compromising this alternation pattern when the airport is operating at or near full capacity. The fast time simulation analysis noted that the runway configuration would be subject to resilience risks at peak times as, when operating in its peak flow, it would have no options for tactical desegregation.

Passenger experience

- 12.20** Passenger experience is by nature qualitative and will be very dependent on the details of the terminal design, but one broad quantitative measure is square metres per passenger – the more space provided, the better the passenger experience is likely to be. On this measure, therefore the level of passenger experience across all three schemes is likely to be similar to or better than today's, with the Heathrow schemes continuing to provide noticeably more spacious passenger facilities than those at Gatwick (**Table 12.2**).

Table 12.2: Space available per passenger at each scheme at busy times, carbon-capped, assessment of need

Scheme	Space per passenger m ² /DHP	Change to current	Comparator
Gatwick Second Runway	Between 29 and 30	Similar to the present rating	Mid-range airport; comparable with many large US airports, as well as a number of substantial secondary European airports
Heathrow Northwest Runway	Between 44 and 45	Similar to the present rating for Terminals 2 and 5	High-end European hub
Heathrow Extended Northern Runway	Between 44 and 45	Similar to the present rating for Terminals 2 and 5	High-end European hub

12.21 At Gatwick Airport, the Commission noted that there was the potential for more significant crowding to occur in the piers served by the midfield terminal, in the event that a number of wide-bodied aircraft carrying a large number of passengers were using these piers at the same time. This is not considered a significant design limitation, but further emphasises the extent to which the midfield facility has been optimised to the needs of low-cost carriers. The Commission acknowledges that detailed design changes could be used to undo some of this optimisation during the delivery of the scheme should fleet mix developments warrant such a move. The transfer passenger proposition is relatively lightweight, particularly in terms of baggage handling.

12.22 At both Heathrow schemes the promoter has put forward a substantial package of measures to support the transfer passenger experience, including an extensive baggage handling system. This is likely to produce a higher quality transfer product than at Gatwick, but it has a significant impact on costs.

Safety considerations

- 12.23** The CAA's Preliminary Safety Review of all three schemes found a number of issues for more detailed investigation and resolution. More work would be needed on all three schemes to resolve issues around missed approach procedures and obstacle limitation surfaces, which define the generally permitted height for structures in the vicinity of the runway, but this is not unusual for schemes at the assessed level of development and none of these issues should be considered 'show stoppers'.
- 12.24** The CAA did note the lack of precedent for the Heathrow Extended Northern Runway concept and indicated that it would need more detailed development. It was emphasised, however, that the CAA remained open-minded on the concept and open to further engagement.
- 12.25** Following a review of consultation responses, the Commission asked the Health and Safety Laboratory to review the scale of increase in crash risk associated with each of the schemes. The review concluded "that the changes to the background crash rate are minimal, regardless of whether or not expansion takes place at the airports."

Conclusion

- 12.26** Both schemes at Heathrow would deliver their increase in capacity (260,000 and 220,000 for Heathrow Airport Ltd and Heathrow Hub Ltd respectively) with a varied fleet mix. In contrast Gatwick would deliver a higher capacity increase (280,000) through a mostly narrow-bodied fleet mix. While the Gatwick scheme provides the largest net increase in ATM capacity, it does so on the basis of a mostly short-haul operation. The Northwest Runway scheme's capacity increase should therefore be considered to be broadly equivalent (and containing a larger resilience buffer). Against the Commission's objective **to ensure individual airport and airports system efficiency** both the total number of ATMs and the fleet mix is taken into account. The Heathrow Northwest Runway scheme, with the second highest capacity increase and flexible fleet mix, is seen as performing most strongly.

- 12.27** All three schemes could be altered via detailed design to meet the needs of a particular demand scenario, and all schemes could perform well against the Commission's objective **to build flexibility into scheme designs**. In the absence of future detailed design change the Heathrow schemes are already relatively 'agnostic' in their designs, and so would work well with all fleet mix possibilities, while the Gatwick scheme would start from a position of optimisation for low-cost carriers, so larger fleet mix scenarios may cause taxiway and terminal crowding issues. As such both Heathrow schemes could be said to perform slightly better (with the Northwest Runway scheme the stronger of the two given the Extended Northern Runway's more constrained airfield).
- 12.28** The Gatwick scheme design reflects well understood design principles and no significant issues are expected in its ability to meet the Commission's objective **to meet present industry safety and security standards**. The Heathrow schemes are more complex, with the missed approach procedures for the Northwest Runway being comparatively complicated and the Extended Northern Runway design representing a novel and untested concept for which substantial regulatory assurance would be needed. However, all of the schemes have the potential to meet the present standards.
- 12.29** No significant points of differentiation have emerged between the schemes with respect to the Commission's objective **to maintain and where possible enhance current safety performance with a view to future changes and potential improvements in standards**.
- 12.30** Against the objective **to enhance individual airport and airports system resilience**, all three schemes represent an improvement against the do minimum scenario. However, this improvement is strongest in the case of the Heathrow Airport Northwest Runway scheme and is combined with the greatest degree of certainty around maintaining the proposed noise respite procedures.
- 12.31** When all objectives are taken into account, it is clear that the differentiating factors between the Gatwick Airport Second Runway and Heathrow Airport Northwest Runway schemes are small, though the latter might be said to perform slightly better, owing to its greater flexibility and resilience. The Northwest Runway scheme clearly performs better than the Extended Northern Runway scheme, due to the larger capacity provision, less constrained airfield and greater certainty of respite.

13. Recommended Option for Expansion

Introduction

- 13.1** The previous chapters set out the Airports Commission's assessment of each of the three shortlisted schemes against its appraisal criteria. This chapter explains the conclusions the Commission has reached on the basis of that assessment.
- 13.2** Each of the three schemes shortlisted for detailed consideration was considered a credible option for expansion, capable of delivering valuable enhancements to the UK's aviation capacity and connectivity. They would each also have negative environmental effects, which would need to be carefully managed, though in all three cases the schemes' developers have sought to limit those where possible through careful design.
- 13.3** Nonetheless, the Commission has unanimously concluded that the proposal for a new Northwest Runway at Heathrow Airport, in combination with the significant package of measures to address its environmental and community impacts described below, presents the strongest case. It delivers more substantial economic and strategic benefits than any other shortlisted option, strengthening connectivity for passengers and freight users and boosting the productivity of the UK economy, and strikes a fair balance between national and local priorities. The Commission's terms of reference required it to make recommendations designed to maintain the UK's position as a global hub for aviation: Heathrow expansion is the most likely route to achieving that.

A Balanced Approach to Expansion

Expanding Heathrow provides a unique opportunity to change the way the airport operates. The additional income generated as a result of operating a third runway should be allocated in a new way, and the airport should be required to develop a better and more collaborative relationship with its local communities, as some overseas airports have done.

The Commission therefore recommends that a number of measures should be taken forward, in parallel with the approval, construction and operation of any new capacity at Heathrow, to address its impacts on the local environment and communities:

- *Following construction of a third runway at the airport there should be **a ban on all scheduled night flights between 11:30pm or before 6:00am.** This is only possible with expansion.*
- *A clear **'noise envelope'** should be agreed and Heathrow Airport Ltd must be legally bound to stay within these limits. This could include stipulating no overall increase above current levels.*
- *A third runway would allow periods of **predictable respite to be more reliably maintained.***
- *Heathrow Airport Ltd should compensate those who would lose their homes **at full market value plus an additional 25% and reasonable costs.** It should make this offer available as soon as possible.*
- *Heathrow Airport Ltd should be held to its commitment to spend **more than £1 billion on community compensation.** In addition, a new aviation noise charge or levy should be introduced to ensure that airport users pay more to compensate local communities. Taken together these would fund enhanced noise insulation and other schemes. Support for schools should be included as a priority.*
- ***Establishment of a Community Engagement Board,** under an independent Chair, with real influence over spending on compensation and community support and over the airport's operations.*
- ***Creation of an independent aviation noise authority,** with a statutory right to be consulted on flight paths and other operating procedures.*
- ***Provision of training opportunities and apprenticeships for local people,** so that nearby communities benefit from jobs in constructing and operating the new infrastructure.*

- **Incentivisation of a major shift in mode share** for those working at and arriving at the airport, through measures including new rail investments, and a continuing focus on employee behaviour change. A congestion or access charge for motor vehicles should also be considered.
- **Additional operations at an expanded Heathrow must be contingent on acceptable performance on air quality.** New capacity should only be released when it is clear that air quality at sites around the airport will not delay compliance with EU limits.
- **Ruling out any fourth runway.** The government should make a commitment in Parliament not to expand the airport further. There is no sound operational or environmental case for a four runway Heathrow.

*These recommendations are discussed in detail in **Chapter 14** of this report.*

- 13.4** With new capacity in place, it will also be possible to reverse the pattern of declining domestic connectivity to Heathrow, which is of significant concern to stakeholders in Scotland, Northern Ireland and other areas of the UK. The Government should be prepared to use Public Service Obligations to support a widespread network of domestic routes.
- 13.5** In contrast to the proposal for expansion at Heathrow rejected in 2010, a full-length runway will be provided, maximising the capacity and connectivity benefits and the level of respite that can be achieved, while its westerly location will limit its noise impacts. Combined with the measures set out above to restructure the airport's relationship with nearby communities and establish an unprecedented long-term funding stream to address local impacts, this offers a radically improved plan and one which is fundamentally different from any previous attempt to expand at Heathrow Airport. It generates significant benefits for the UK as a whole and is fair and deliverable, balancing the needs of the airport's users with the concerns of those living nearby.
- 13.6** The Commission recommends strongly that if a new runway is to be delivered, the Government should support the implementation of this plan in its entirety.

The Case for Heathrow

Connectivity and economic growth

Introduction

- 13.7** Heathrow Airport plays a central role in maintaining the London aviation market's position as the largest and most valuable in the world. It is the UK's largest airport, providing more than 70% of the country's long-haul flights, and carrying more freight by value than all the UK's other airports combined. It has strong surface transport links, which will be further enhanced by the opening of Crossrail and HS2 and the recently opened Terminals 2 and 5 have significantly improved the passenger experience at the airport and are ranked among the world's best by travellers. That this pattern has been maintained over a sustained period when the airport has been operating at capacity is testament to its inherent attraction to passengers, airlines and the air freight industry.
- 13.8** Its two runways have, however, been operating at capacity for many years. This has limited its ability to accommodate new routes, including to the fast-growing markets of Asia, Africa and South America, and the number of links to domestic destinations has declined. It has also been damaging for local communities, as it has increased the importance of the airport's small number of pre-6:00am flights and led to regular losses of runway alternation due to the congested pattern of arrivals and departures in the early morning.
- 13.9** A third runway at Heathrow would build on the airport's success and tackle its weaknesses. By providing capacity for an additional 260,000 air traffic movements a year, including a large number of additional slots in the morning and evening peak periods, there would be significant opportunities to establish new links, particularly on the long-haul routes needed for the UK to prosper in an increasingly integrated global economy, drawing on both an unrivalled origin-and-destination market and an expanding pool of transfer passengers. It would also enable new entrants, including low cost carriers, to establish themselves at the airport, provide healthy competition for incumbent airlines, and support continuing growth in its freight operations.
- 13.10** While expansion at Gatwick would also deliver improvements in the UK's aviation capacity and connectivity, these would be more likely to be focused on short-haul and European links. The number of long-haul destinations at an expanded Gatwick would be at most 4 higher in 2030 than it would be if no new capacity is added and by 2050 only 1 higher, and at national level long-haul capacity would only increase by up to 5 million seats; this compares to up to 12 additional long-haul destinations

at an expanded Heathrow and up to 16 million extra seats nationally. The degree of global connectivity and the wider impacts on the UK economy created by expansion at Heathrow could not be delivered by a second runway at Gatwick.

Capacity and connectivity

- 13.11** The Commission's *Interim Report* identified that the best approach to enhancing the UK's aviation capacity and connectivity is to invest in an airport system that is flexible and adaptable, catering effectively for a range of airline business models. The most significant constraint in the South East system is a lack of the necessary capacity to promote hub connectivity, in which origin and destination passengers are supplemented by transfer traffic to support the establishment of new routes. A dense route network and diverse aviation market are particularly important for developing long-haul connections, where transfer passengers and freight can be the crucial factor in making a link viable.
- 13.12** Access to Heathrow is highly sought after by airlines, especially from major long-haul carriers, including those from emerging markets, but has been heavily constrained for many years due to the lack of runway capacity. That has led to high prices for slots at the airport,⁸⁷ creating challenging barriers to entry and indicating strong suppressed demand. The airport accommodates more flights on its two runways than any equivalent airport in the world, but is now at the limit of the capacity that can be provided. The result is that the aviation industry is very restricted in its ability to expand the route network at the airport.
- 13.13** Some services offered by European hubs but not by Heathrow, such as routes to primarily leisure destinations in Europe, North Africa and the Caribbean, have been established from other London airports, including Gatwick, which partially compensates. But the capital as a whole has not been able to develop the routes to new long-haul destinations that might be expected given the scale of the London market and the changing orientations of UK trade and investment flows. Although London airports provide strong links to India, for example, other European hubs serve more cities in the Far East, China, Africa and South America. Improving aviation connectivity to these destinations would provide substantial benefits for UK travellers and for the economy.

87 Recent transactions for slots at Heathrow include American Airlines' purchase of one slot pair from Cyprus Airways for \$31m in June 2014 (<http://airwaysnews.com/blog/2014/06/16/american-airlines-acquires-london-heathrow-slot-pair-for-31-million/>) and Turkish Airlines' purchase of a slot pair from SAS for \$22m in February 2015 (<http://www.flightglobal.com/news/articles/sas-sells-heathrow-slots-to-turkish-airlines-409533/>).

13.14 Expansion at Heathrow would tackle that deficiency directly by providing a substantial increase in capacity – up to 260,000 air traffic movements a year – at the UK’s major hub airport. A new runway would enable passengers and freight users to benefit from additional routes and increasing frequencies delivered by the network carriers, such as British Airways, and major airline alliances currently based there. Expansion at Heathrow would not only be of benefit, however, to the established carriers at the airport. By creating a large number of new slots for the first time in several decades, it would create opportunities for other airlines, including low-cost carriers, to enter the market at Heathrow; and if services also relocate from other London airports, many of which will be capacity constrained by the time a new runway opens, it could create space for growth elsewhere for domestic, European and other point-to-point links.

13.15 The substantial suppressed demand for slots at Heathrow Airport means that as new capacity becomes available rapid growth in passenger numbers is expected, and would be noticeably faster than with a second runway at Gatwick (see **Figure 13.1**). This reflects both the overall scale of London’s origin and destination market and the attractiveness of Heathrow for passengers due to its strong local transport links, dense route network and frequent services. The latter two are also of importance for transfer travellers. This combination makes expansion at Heathrow best-placed to enhance the UK’s long-haul links, which will be increasingly important as the world economy’s centre of gravity continues to shift eastwards. With additional runway capacity, the airport’s dense route network could see significant growth, maintaining its status as one of the major focal points in the global aviation system and enhancing the UK’s overall connectivity.

Figure 13.1: Passenger growth is stronger with expansion at Heathrow than at Gatwick

Forecast passenger numbers at each scheme, carbon-traded and carbon-capped, *assessment of need*

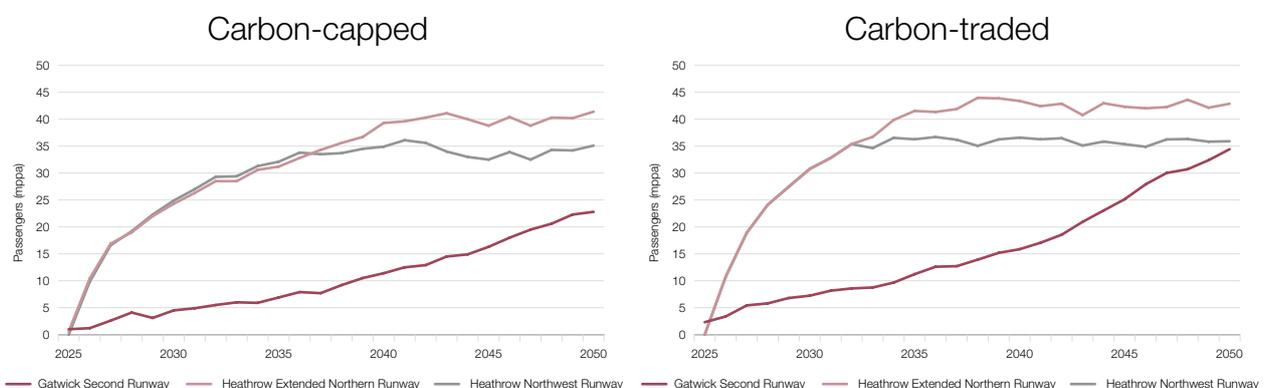

- 13.16** These effects would be supported by the strengthening of Heathrow's hub status that additional capacity would make possible. With expansion, airlines operating from Heathrow could compete more effectively for transfer passengers with other European and international hubs. Attracting transfer passengers should not be seen as an end in itself. But they can be a decisive factor in determining the viability of a route which is economically advantageous to the UK. Without expansion, the number of international transfer passengers at Heathrow is forecast to fall from 20 million a year in 2014 to 8 million or fewer by 2050; with expansion this pattern of decline could be reversed, seeing up to 30 million international transfer passengers by 2050. Expansion in capacity would also enable the airport to operate more efficiently as a hub, as network carriers could use the new slots that become available to move more towards operating arrivals and departures in wave patterns, maximising the number of connections available for passengers.
- 13.17** This analysis is reflected in the Airports Commission's forecasts, which indicate that increasing capacity at Heathrow would see passenger numbers at the airport increase rapidly from the current level of approximately 70 million to over 100 million by 2030 and over 130 million by 2050. This would drive significant connectivity benefits, both at the expanded airport and nationally. For example, with a new Northwest Runway there would be more than 30 new destinations with at least daily services from the airport by 2040, of which around ten would be long-haul, delivering a much stronger long-haul network than would be seen at an expanded Gatwick (see **Figure 13.2** below). At national level, the total number of long-haul seats in the same year would be 7-16 million higher compared to the baseline, depending on the treatment of aviation's carbon emissions.

Figure 13.2: Heathrow expansion delivers greater long-haul connectivity than a second runway at Gatwick

Number of daily destinations for each scheme, carbon-traded and carbon-capped, 2030-2050

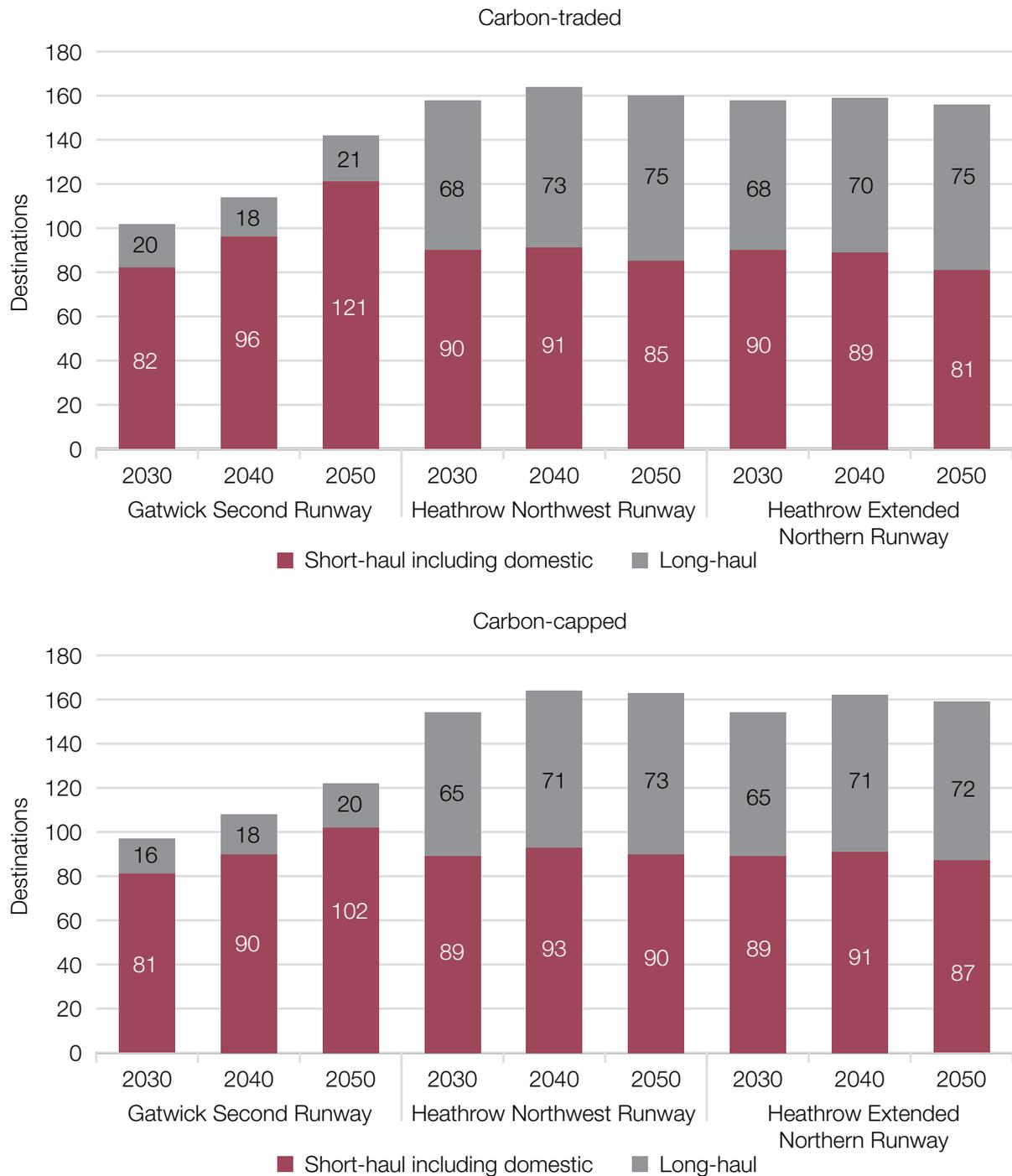

Source: Airports Commission analysis

13.18 Expanding Gatwick would also increase the UK's aviation capacity, creating space for 280,000 additional movements at the airport and delivering valuable improvements in connectivity. That is particularly true in relation to the short-haul

European links that are forecast to remain the largest part of the UK's overall aviation market; by 2050 its short-haul network would be larger than at an expanded Heathrow.

- 13.19** Over the longer term, increasing numbers of long-haul services would also be established from Gatwick, but without a significant transfer market they would be likely to serve mainly the densest routes. This could incorporate routes to other hubs, including those in emerging markets, from which local carriers would provide onward connections. Expansion at Gatwick might also provide an alternative option for some of those services from Heathrow which are less dependent on transfer traffic, particularly given the availability of peak hour slots. But any increase in long-haul destinations from the airport as a result of expansion would be small, and at national level it would not increase the scale of the UK's long-haul network to the same extent as new capacity at Heathrow, with only 1-3 million additional long-haul seats by 2040 and 1-5 million by 2050.
- 13.20** For Gatwick expansion to deliver connectivity benefits closer in scale to those from Heathrow, substantial changes would be needed, such as an airline alliance moving to the airport, low-cost carriers making significant incursions into the long-haul sector or the structured use of low-cost networks as 'feeder' services for long-haul carriers. None of these is impossible, but it would be imprudent to base a long-term infrastructure planning decision on uncertain developments of this kind. The airline alliances have said they have no interest in such a move and the major UK-based low-cost carriers do not serve any long-haul routes. Furthermore, even if they were to occur, that would not necessarily lead to the establishment of the broad route network, including links to a wide range of destinations in emerging markets, which will be central to the UK's long-term economic prosperity.
- 13.21** Without such shifts in the structure of the aviation industry, expansion at Gatwick would accommodate significant and valuable growth in the short-haul and point-to-point markets, and by attracting some flights from Heathrow which are less dependent on transfer traffic it may act as a 'pressure valve' for the main UK hub. But it would not provide the same boost to the UK's overall connectivity as adding capacity at Heathrow or be as effective in maintaining the UK's position in the global aviation system in the face of competition from other major airports in Europe and the Middle East.

Accessing the airport

- 13.22** Heathrow is not just well-connected globally, it also has strong local and national transport connections, which make it accessible to a wide area of the country.

- 13.23** Rail access to London is available via the Piccadilly Line and via Heathrow Connect and Heathrow Express services into Paddington, with the latter reaching the city centre in just 15 minutes. The introduction of Crossrail services to the airport in 2019 will further enhance its links to London, providing direct access to key business districts in the West End, City and Canary Wharf as well as to the major growth areas in the east of the capital. The proposed surface access strategy for the expanded airport also includes a Southern Rail Access link, which will connect the airport to Waterloo and a number of other districts, such as Richmond, which are currently poorly linked to the airport by public transport.
- 13.24** Rail access to other regions is not as strong at present, but will be transformed by a combination of the planned Western Rail Link to Reading, from where passengers will be able to change onto services to the West, South West and Wales, and the connection to HS2 at Old Oak Common. With the HS2 link in place, journey times from the major cities of the Midlands and the North will be substantially reduced, with Manchester and Leeds, for example, moving to within 90-100 minutes of the airport compared to more than three hours currently.⁸⁸ The Southern Rail Access Link may also enable direct access from towns such as Woking and Guildford to the south west of the airport. With these improvements, some 38 million people would live within three hours' travel of Heathrow by 2030. The opening of the second phase of HS2 in the 2030s would increase this further.
- 13.25** Gatwick has convenient rail connections into the centre of London, including to Victoria (via Clapham Junction) and to London Bridge and St Pancras International via the Thameslink route, which also provides a link to Crossrail at Farringdon. Its broader rail connections, however, are not as strong. The Brighton Main Line provides good links to the main conurbations of the South Coast and the upgraded Thameslink network will provide direct connections to Cambridge, Peterborough and East Anglia, in addition to the services already available to Luton and Bedford, but the airport would not be connected to HS2 and passengers arriving via the West Coast, East Coast and Great Western Main Lines would need to change trains and travel across the capital by rail or tube to reach the airport.
- 13.26** The levels of crowding seen in peak hours on the rail links serving Gatwick are forecast to be less severe than on those serving Heathrow (assuming investments are made over and above current plans on the Brighton Main Line). The worst affected lines will be the Southern Rail Access link and the central sections of Crossrail, although the Piccadilly Line will also experience significant congestion as

88 See: http://assets.hs2.org.uk/sites/default/files/consulation_library/pdf/P2C37_Journey%20times%20and%20frequencies%20LOW.pdf

it approaches central London. Nonetheless, for either airport the challenges are primarily driven by background demand growth which the Government will need to take action to address whether expansion takes place or not.

- 13.27** In respect of the strategic road network, Heathrow's position close to the M25, M4 and M40 makes it well-located for access from much of the country, which contrasts with Gatwick's less convenient location to the south of London and its reliance on the M23. The motorway links serving Heathrow are amongst the most congested in the country, meaning that significant additional investment in widening, or effective policy measures such as a congestion charge, may be needed to accommodate growth in traffic resulting from the airport's expansion. While a second runway at Gatwick does not present the same level of challenge, that is not considered to outweigh its locational disadvantage.

Competition and growth

- 13.28** Expansion at Heathrow would also provide other benefits for passengers. Additional capacity would further enhance competition at the airport, helping to reduce fare levels and increase choice for passengers. A substantial low-cost presence at the airport, made possible by new slots becoming available, could significantly drive down the costs of travel from the airport, even allowing for any increase in aeronautical charges required to fund the costs of adding capacity. New carriers would also enter the long-haul market, which sees limited competition at present on many routes. The competition benefits from expanding at Heathrow would be stronger than those generated by a new runway at Gatwick, reflecting the higher level of unmet demand at Heathrow and the greater scope to deliver cost reductions through low-cost competition.
- 13.29** The substantial increases in capacity, connectivity and competition provided by a new runway at Heathrow deliver very substantial benefits for passengers, with a Present Value of up to £55 billion over 60 years in the Commission's carbon-traded forecast, of which approximately 37% accrue to business travellers. The passenger benefits created by expanding at Gatwick are smaller, at £47 billion, as is the proportion which relates to economically valuable business travel, although they are still very significant.
- 13.30** With carbon emissions constrained to the CCC's planning assumption these benefits reduce, but the pattern remains the same. The passenger benefits from expansion at Heathrow are cut to a maximum of £34 billion over 60 years, whereas the benefits from Gatwick expansion fall to £27 billion. Heathrow's benefits to

business travellers with carbon emissions constrained to 37.5MtCO₂ are up to a third higher than those from expansion at Gatwick.

- 13.31** It is not only passengers, however, that would benefit from expansion at Heathrow. As explained in **Chapter 2**, air freight is an important contributor to the UK economy, with a particularly important role in supporting trade with countries outside the EU. The air freight industry is responsible for around 40% of the UK's trade in goods with non-EU countries, and makes an important contribution to reducing the UK's balance of trade deficit, with non-EU exports by air exceeding imports in 2014 by £15 billion. Annual growth in air freight between developing and emerging economies is forecast to exceed 5% over the period to 2032, compared to less than 3% between developed economies, which underlines the importance of wide-ranging aviation route networks, incorporating links to destinations in fast-growing regions such as the Far East and Africa.
- 13.32** Heathrow is by some distance the most important freight airport in the country, reflecting the criticality for the sector of a dense route network and, in particular, a broad range of long-haul connections. As a result, the scale of the freight operation at Heathrow is very significantly larger than at Gatwick: around 17 times larger in terms of tonnage, but more than 170 times larger in terms of value. Gatwick is only the UK's ninth largest freight airport by value, behind airports including Stansted, East Midlands, Manchester and Glasgow.
- 13.33** Effective access to the national motorway network is also crucial for air freight, enabling logistics companies to bring goods for export into the airport efficiently and to transport imports quickly to their final destination. Heathrow is well-placed to provide this, whereas Gatwick's position to the south of London limits its effectiveness as a national freight hub. This can be seen clearly from the map below (**Figure 13.3**), which shows the location of logistics businesses in the South East of England.

Figure 13.3: Third-party logistics companies are highly clustered around Heathrow

Map showing the location of third-party logistics companies in the South East

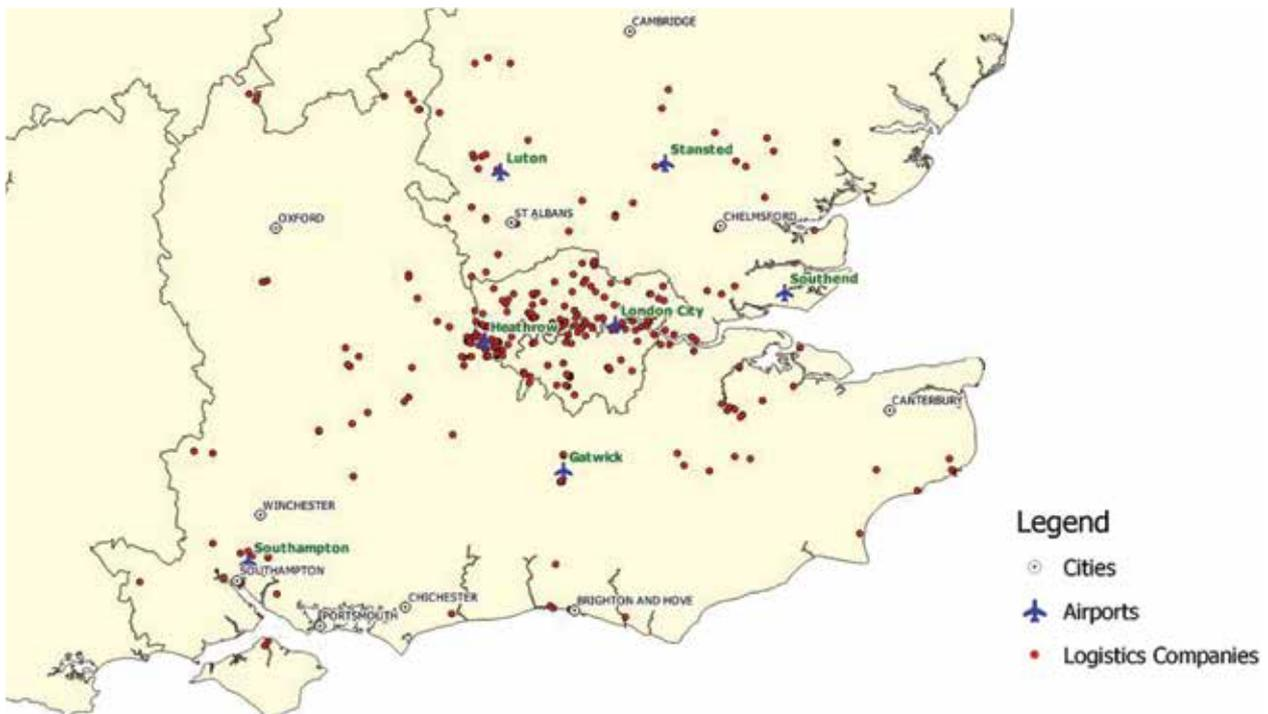

Source: PwC

13.34 A key strength of an expanded Heathrow would be its ability to build on its strength in the air freight sector and support growth in this important market. While expansion at Gatwick would also provide an increase in capacity, it would be unable to match these benefits. The low-cost carriers which account for the bulk of Gatwick's current business do not carry much freight: their fast turnaround business model makes that difficult. It would deliver fewer of the long-haul links which are of particular importance to freight forwarders, and the limited size of its current freight operation, together with its less attractive location for the logistics industry, mean that it would be likely to take a long time for a substantial freight operation to develop. In contrast, the existing cluster of freight businesses around Heathrow would be well-placed to respond quickly to the opportunities created by expansion. The Commission's analysis of the impacts of expansion on the wider economy shows stronger and more rapid growth in the air freight sector from new capacity at Heathrow (see **Table 13.1** below).

Table 13.1: Expanding Heathrow delivers stronger growth in air freight

Impact on Air Freight GDP (%)	2030	2040	2050	2060
Gatwick Second Runway	-0.6 ⁸⁹	0.3	1.4	2.6
Heathrow Extended Northern Runway and Northwest Runway	2.6	3.3	3.7-3.8	4.9-5.1

- 13.35** Overall, the analysis suggests that the strongest benefits for the UK economy are likely to come from focusing capacity where demand is strongest: be that from freight users needing to export goods to the widest range of destinations, from leisure passengers going on holiday or visiting friends and family, from business passengers seeking to access new and emerging markets or from the international transfer passengers required to support a dense long-haul network and incubate routes to new countries and cities. In each case, the Commission's view is that the highest levels of demand are seen at Heathrow Airport.
- 13.36** These factors are reflected in the Commission's strategic and economic impact assessments. Providing new capacity at either Heathrow or Gatwick would support trade and enhance productivity, strengthen the business clusters around the airport and provide a stimulus to economic growth throughout the UK, but the effects will be felt most strongly if capacity is added at Heathrow. As these impacts foster investment through the wider economy, the overall effect of Heathrow expansion could be to increase GDP by 0.65-0.75% by 2050, amounting to £131-147 billion in Present Value terms with carbon emissions traded over the 60 years following the opening of any new runway capacity. This compares to £89 billion in GDP impacts from expansion at Gatwick. Heathrow expansion also outperforms a second runway at Gatwick in relation to the trade-related productivity element of this analysis, delivering up to £79 billion in productivity impacts – around £17 billion more than from the Gatwick scheme.⁹⁰
- 13.37** The relative case for expansion at Heathrow is strengthened as tighter constraints are put upon carbon emissions from aviation. With emissions constrained in line with the CCC's planning assumption, the economic impacts are reduced for all three schemes but the gap between Heathrow and Gatwick expansion widens. The GDP impacts of Heathrow expansion fall to £103-129 billion, depending on the expansion option, whereas the impacts of a second runway at Gatwick reduce to

⁸⁹ The negative impact in the early years following expansion at Gatwick reflects the dynamic nature of the economic model, whereby an expanded Gatwick attracts flights from airports with larger freight businesses. In the longer-term, the freight sector at Gatwick grows sufficiently to outweigh this effect.

⁹⁰ As well as these trade productivity impacts, other elements of the S-CGE analysis may also incorporate productivity effects, which would increase these figures further.

£44 billion. Similarly, while the trade productivity impacts drop by no more than £10 billion at Heathrow, those from expansion at Gatwick fall by just over £25 billion.

13.38 In the Commission's view, the more that aviation's 'carbon budget' shrinks, the more important it becomes for this budget to be used as efficiently as possible. To achieve this, capacity has to be available where it is most needed. As the effects of stronger carbon policies begin to be felt across the economy, alternatives to aviation will become more attractive, but many trips will still need to be made by air, particularly to long-haul destinations. The most effective option to achieve this is expansion at Heathrow, which provides the greatest benefits for the UK's overall connectivity and its long-term economic growth.

Securing benefits for the country as a whole

13.39 The enhanced capacity and connectivity provided by expansion at Heathrow will support increased employment and economic growth at the local, regional and national level. While such benefits would be substantial if new capacity were provided at either shortlisted airport, expansion at Heathrow makes the strongest case.

13.40 Heathrow Airport is situated in an area of West London in which unemployment is relatively high. In only one of the five local authorities surrounding the airport is unemployment significantly below the national average. The airport is an important employer across these authorities, with more than 6% of the workforce directly employed at the airport in every case except Ealing (where the airport still provides 3.7% of local jobs).⁹¹ And there are many further jobs in businesses that depend on the airport, or on the spending of those employed there.

13.41 The employment benefits from the airport are spread more widely, however, than just these five authorities. Even the ten local authority areas closest to the airport account for only 63% of on-airport employment, with the remainder being drawn from still further afield. This reflects the strong transport links to the airport, which make it accessible from much of London and other surrounding areas, including in particular the Thames Valley region. Future improvements to the transport networks serving the airport will increase its reach further.

91 Figure calculated from ONS population forecasts and Heathrow Employment Survey 2013.

- 13.42** Expansion at Heathrow would drive a substantial increase in employment at and around the airport, generating an additional 59-77,000 jobs in 2030 for local people and for the fast-growing wider population in London and the South East, including for the minority ethnic communities for whom Heathrow is an important employer. Almost a quarter of its employees are from the Asian community and a further five per cent from black and minority ethnic community, significantly in excess of the national average.⁹² Overall, the economically active population is forecast to expand by more than 100,000 people over the period to 2030 in the five authorities closest to Heathrow, and by more than 160,000 in a wider group of fourteen authorities surrounding the airport. The new jobs created by expansion would provide valuable opportunities for that growing workforce.
- 13.43** The number of jobs resulting from a second runway at Gatwick would be smaller and the rate of growth slower. In addition, with the exception of Crawley and Mole Valley, the nearby local authority areas have comparatively low rates of unemployment, suggesting that there would be different consequences for the character and economy of the local area with fewer regeneration benefits (although the broader employment effects may have a positive impact in a wider group of local authority areas such as Croydon). **Table 13.2** compares the local areas around Heathrow and Gatwick and the employment impacts of expansion.

92 Heathrow Employment survey 2013, IpsosMORI; available in Background Information Volume 1 at <https://www.gov.uk/government/publications/additional-airport-capacity-heathrow-airport-north-west-runway>

Table 13.2: Employment impacts of expansion

Gatwick			
Local Authority Area	Number of on-airport employees	Share of Local Authority Area employment (%)	Local Authority Area unemployment rate (2013)
Crawley	1,405	2.6	9.8
Epsom and Ewell	n/a	n/a	5.7
Horsham	312	0.5	2.6
Mid Sussex	363	0.5	2.8
Mole Valley	62	0.1	7.0
Reigate and Banstead	417	0.6	3.7
Tandridge	107	0.3	5.6
Employment growth from expansion (000s)	2030	2050	
Carbon-traded (carbon-capped)	6,500 (4,100)	32,100 (12,700)	

Heathrow			
Local Authority Area	Number of on-airport employees	Share of Local Authority Area employment (%)	Local Authority Area unemployment rate (2013)
Hounslow	10,760	8.3	7.3
Ealing	5,760	3.7	9.9
Slough	4,090	6.1	8.2
Hillingdon	8,960	6.7	7.7
Spelthorne	3,920	7.8	4.9
Employment growth from expansion (000s)	2030	2050	
Extended Northern Runway carbon-traded (carbon-capped)	76,700 (61,800)	65,600 (63,800)	
Northwest Runway carbon-traded (carbon-capped)	76,700 (59,300)	78,400 (74,700)	

- 13.44** The positive impacts of expansion at Heathrow would also be well-aligned with London's broader development and that of the surrounding region. The airport is situated within the Heathrow Opportunity Area, which is identified in the London Plan as a key location for economic development and housing growth. The Opportunity Area is also part of the broader 'Western Wedge' corridor running from Paddington to the Thames Valley, whose economy is already strongly supported by the connectivity provided by Heathrow and would benefit significantly from expansion.
- 13.45** The London economy as a whole is driven by sectors which are heavily dependent on aviation, from financial and creative services to high value manufacturing. Rapid and direct access to the strongest possible aviation links will play an important role in maintaining London's status as a global business centre. Heathrow's direct connection to Crossrail will link it to the capital's main business districts, including the West End, City of London and Canary Wharf, as well as new and developing areas such as Stratford, Old Oak Common and the Paddington Basin.
- 13.46** London also faces other strategic challenges. A rapidly expanding population, due to grow to more than 10 million by 2030, will need homes and jobs. Many of the areas identified for the highest levels of housing growth in the London Plan will have fast and convenient access to the airport via Crossrail or other transport links, from Old Oak Common in West London (where a minimum of 24,000 new homes are planned) to the Isle of Dogs, Lower Lee Valley and Royal Docks in the east (where 11,000, 32,000 and 10,000 homes respectively are planned). Stratford and Custom House stations will be no more than 45 minutes from Heathrow, and Canary Wharf just 38 minutes. These links will ensure that people across a wide area of London, including the growth areas in the east of the city, can benefit not only from the broader economic effects of expansion, which will support growth across the capital, but also from the employment opportunities created at and around the airport.
- 13.47** The increased employment generated by expansion at Heathrow may lead to new demand for housing in the airport's more immediate vicinity. The strong surface access links described above would help to limit this by making jobs accessible to a wider catchment. At the more local level, rising population densities in the areas around the airport would mitigate the land take implications of any new housing development and a combination of increased financial support and effective integrated planning across local authority boundaries could mitigate impacts for communities.

- 13.48** Expansion at Gatwick would also deliver valuable economic and employment benefits. Gatwick is part of the Wandle Valley strategic corridor, and expansion would support Croydon's ambitions to become an airport city. It has good road and rail links to many towns and cities south of London and on the south coast and its expansion is supported by regional business groups including the Gatwick Diamond and the Coast to Capital Local Enterprise Partnership. The impacts of expansion at Gatwick on housing demand would be smaller than those of Heathrow, although they would affect a more rural local area. Despite these advantages, however, a second runway at Gatwick would not match the broader strategic impact of new capacity at Heathrow. This is due both to the lower overall scale of its impacts, the limited scale of the regeneration opportunities in the vicinity, with the exception of Croydon, and its weaker links to the capital's major growth areas, with no direct rail connection in particular to any location to the east of Farringdon or London Bridge.
- 13.49** Outside London, cities and regions across the UK would also benefit from access to the enhanced connectivity secured through expansion at Heathrow. Closest to the airport, the Thames Valley economy is a thriving agglomeration with specialisms in information technology and financial services, and a substantial logistics sector; and which has attracted major technology multinationals such as Microsoft and Oracle and global pharmaceutical firms including Eli Lilly and Boehringer Ingelheim, reflecting the importance of aviation connectivity in attracting foreign direct investment. The Thames Valley Local Enterprise Partnership (LEP) region has a higher proportion of foreign-owned enterprises than any other LEP area in the UK, and significantly outperforms in GVA terms the Coast to Capital LEP region in which Gatwick lies. Expansion will help to maintain this pattern of success by enhancing the international connectivity which is a key strength of the region.
- 13.50** Efficient and rapid access to the best possible international connectivity, including long-haul links to emerging market destinations, will also play an important role in supporting economic growth in the major city-regions of the Midlands and the North, in line with the Government's evolving policy to create a Northern Powerhouse, and helping to rebalance the UK economy. While regional airports including Manchester and Birmingham are attracting rising numbers of long-haul services, particularly on routes to international hubs such as Dubai, New York and Hong Kong, other, more marginal, links are always likely to depend upon the greater weight of demand in the London market. As discussed above, this demand is strongest at Heathrow. Enhanced domestic aviation links to the airport, combined with the direct link to HS2 at Old Oak Common and the Western Rail Link from Reading will ensure that the benefits of expansion at Heathrow are felt across the English regions.

- 13.51** A new runway at Gatwick would not be as accessible to regional passengers nor would it deliver the same level of connectivity benefits. Its location to the south of the capital, while enabling easy access from many of the towns and cities on the south coast, makes the airport less accessible than Heathrow from many other regions. In addition, the international route network available at Gatwick would not be as extensive as at an expanded Heathrow, particularly with regard to the thinner long-haul connections which would not be available from the major regional airports.
- 13.52** For nations and regions where domestic air connections to London remain crucial, such as Scotland and Northern Ireland, expansion at Heathrow will create space at the airport for increased frequencies and for new links to be established. The number of services from Scottish airports to Heathrow has declined by more than a quarter over the past 10 years, and to Gatwick by almost 20% over the same period. Expansion at either airport would provide the opportunity to reverse that trend, and would strengthen access to London from Scotland, as well as to the capital's wider international route network.
- 13.53** These benefits would be felt most strongly with expansion at Heathrow, as it can provide access to the strongest international connectivity. A number of UK airports have developed links to other hub airports, both in Europe and further afield, which are highly valued by regional stakeholders. But they are generally considered a supplement to, rather than a replacement for, connections to Heathrow, whose strong route network, particularly to the United States, is not replicated by any other hub. The growth in its global long-haul route network forecast as a result of expansion will make access to Heathrow even more important in future.
- 13.54** The Commission's forecasts suggest that with expansion more than twice as many domestic passengers will travel via Heathrow in 2040 than if the airport's capacity remains constrained. In addition, to ensure that cities and regions across the UK can benefit from Heathrow's enhanced connectivity, including areas such as the Highlands and Islands, the Isle of Man and the Tees Valley, which have lost their direct links to Heathrow over recent decades, the Government should use Public Service Obligations to support a widespread network of domestic routes.
- 13.55** An expanded Gatwick would also see a significant increase in the number of domestic passengers using the airport, enhancing access to London and to Gatwick's strong network of European routes from those parts of the UK which most depend on aviation links, such as Scotland and Northern Ireland. Gatwick currently has more domestic connections than Heathrow and this pattern is forecast to continue. Domestic passengers at Gatwick would not, however, be able to

benefit from as strong a long-haul network, including links to economically important emerging market destinations, as at Heathrow.

- 13.56** The economic impacts of expansion at Heathrow would be felt throughout the UK, and that is reflected in the Commission's S-CGE analysis. It shows that the effects of expansion would be felt most strongly in the air passenger and freight sectors, but with increases in economic activity also seen across the country in other sectors with international linkages, such as manufacturing and accommodation and food services. In total, the analysis indicates that around 60% of the overall boost to GDP would be focused on areas of the UK outside the South East of England. This would deliver an increase in GDP in these regions of approximately £70-80 billion (present value over 60 years) from expansion at Heathrow, compared to just under £50 billion from expansion at Gatwick.

Protecting the local environment and communities

- 13.57** In considering the shortlisted options, the Commission has been acutely conscious of their environmental impacts, and particularly those of an expanded Heathrow. The areas surrounding Heathrow are more populous and developed than those around Gatwick and it is therefore inevitable that significantly more people would be affected by aviation noise. The airport's location close to a number of major motorways and radial routes into London presents challenges for managing and reducing air pollution. And each option for expansion would require the loss of many homes, as well as having impacts, even if less substantial, on issues such as biodiversity and flooding which need to be taken into account.
- 13.58** The environmental impacts of aviation, particularly in relation to noise and air quality, have consequences for health and for well-being, which need to be carefully considered and addressed wherever possible through effective mitigation and compensation. Aviation noise can have particular impacts on children's learning. The Commission considers that it is crucial to tackle this under any scenario, through measures such as noise insulation for school buildings, which research has shown can deliver substantial improvements.
- 13.59** Over the coming decades the noise impacts of Heathrow are forecast to reduce significantly, as new and quieter aircraft come into service and as flight paths are redesigned and improved, including through the use of new navigational technologies. Expansion at Heathrow would bring further change to the airport's noise footprint. The overall number of flights would grow, but new approach and departure paths could enable the noise impacts to be dispersed more widely, limiting the impacts on any individual community. Careful flight path design, based

on thorough public consultation, can ensure noise is managed in a way which best reflects the priorities of nearby communities. In this way, it is possible to ensure that noise from the airport during the daytime, with either option for expansion, although higher than forecast from a two-runway airport in future, would not exceed current levels across a wide range of metrics (see **Figure 13.4**).

Figure 13.4: Noise impacts of Heathrow expansion, carbon-capped, 2013 and 2030

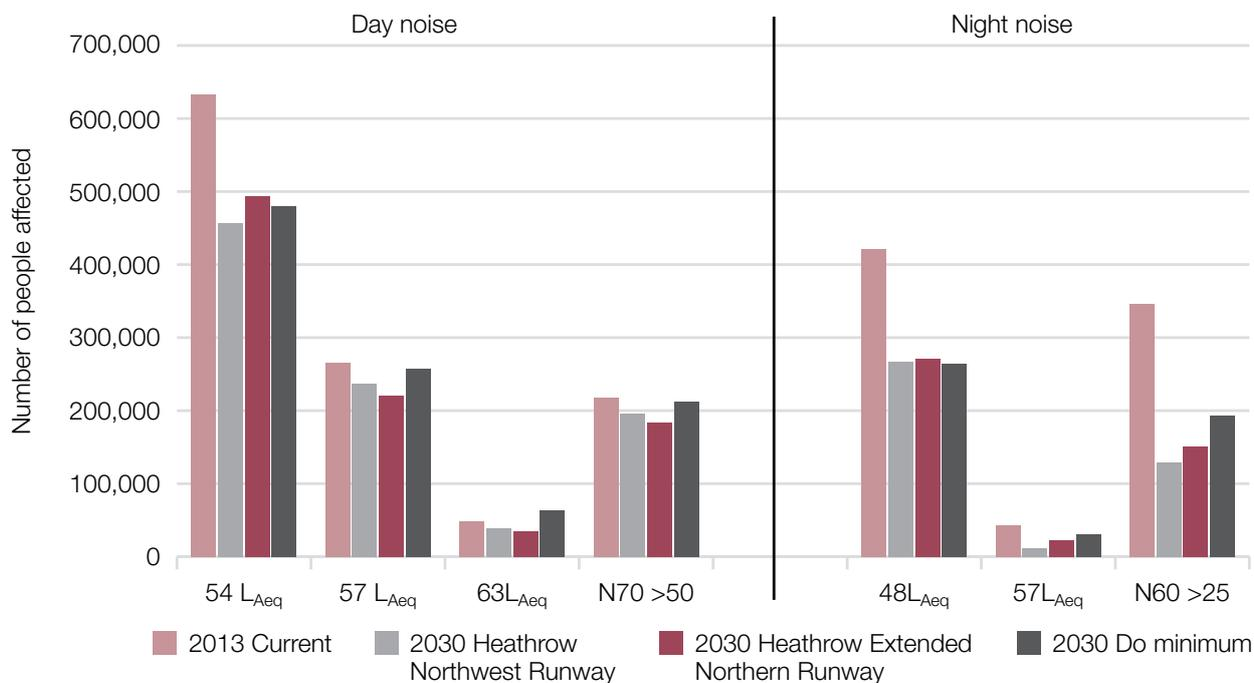

Source: Airports Commission analysis

13.60 As **Figure 13.4** also shows, the picture is positive in respect of night time noise, as it would be possible to focus operations on the new runway capacity in the early morning and late evening, which under either proposal would be to the west of the existing runways, meaning flights would be higher over London as they get close to the airport, reducing noise levels for those living underneath the approach path. In addition, as discussed in the next chapter, a third runway would make it possible to eliminate arrivals in the early morning before 6:00am, which are seen as particularly damaging by local communities. Taken together, these changes would ensure that a third runway provides a significant improvement in the night noise environment.

13.61 It is not enough, however, to demonstrate the theoretical scope to enhance the noise environment through modelling, without taking steps to ensure those results are delivered on the ground. So in taking the scheme forward, a ‘noise envelope’ for the airport would need be established which reflects local priorities and incentivises the development and implementation of effective measures to mitigate noise impacts. This could include stipulating that daytime noise does not exceed

current levels and that an overall reduction in night noise is delivered. It would also mean ensuring that a substantial and permanent funding stream is available to provide compensation and noise insulation, including for schools and other community facilities. The expanded airport should provide a significant level of funding for such measures, which would be supplemented by income from the aviation noise levy discussed in the next chapter.

13.62 The noise impacts of Gatwick are less severe than those around Heathrow, although compared to current levels the Heathrow schemes perform more strongly. The numbers of people affected by aviation noise would increase significantly compared to today once a second runway was in place at Gatwick, with the population within the 55_{L-DEN} contour growing by more than 10,000, whereas the numbers around Heathrow would be lower than currently. The overall numbers of people affected would, however, remain very substantially higher at an expanded Heathrow, where more than 550,000 people fall into the same contour in 2030, compared to just over 20,000 at Gatwick. That reflects Gatwick's more rural location, which presents some challenges in respect of managing the airport's effects on tranquility, but does not outweigh its overall noise advantage.

13.63 The area around Heathrow also experiences levels of air pollution from nitrogen dioxide (NO₂) which currently breach the limit set in European regulation of 40 micrograms per cubic metre. Air quality in the UK has improved significantly over recent decades and these improvements are forecast to continue. Even with additional runway capacity in place, none of the air quality receptors around Heathrow which would have implications for human health, such as at schools or residential buildings, are forecast to exceed air quality limits in 2030. Without mitigation, around 39-47,000 homes around Heathrow would experience a worsening of NO₂ levels, compared to just over 20,000 around Gatwick. The number of properties moving into the 'at risk' category (more than 32 micrograms per cubic metre) is much smaller – as few as 14 for the Northwest Runway scheme.

13.64 There remain particular challenges in relation to the achievement of the EU air quality limits on the Bath Road close to the airport's northern perimeter – an area of mainly business and light industrial development. This is a result of the emissions both from the operations of the airport and from major roads nearby and is considered below in assessing the relative performance of the two Heathrow schemes. While expansion at Gatwick would also increase emissions in the local area, with approximately 21,000 properties forecast to experience a worsening of air quality, it does not lead to similar challenges in respect of the European limits.

- 13.65** Firm action will therefore be needed on the part of the airport operator to ensure that emissions related to the airport are minimised, together with an effective national strategy to address broader background air quality issues, as recently stipulated by the Supreme Court. Any new capacity should only be released when it is clear that air quality at sites around the airport will not delay compliance with EU limits. That will require both the implementation of a range of on-site measures, for example reduced engine usage during taxiing, and potentially wider steps such as the implementation of a congestion charge to prevent traffic levels rising as a result of expansion. The levels of challenge associated with the two Heathrow options, however, are significantly different, as discussed below.
- 13.66** Effective mitigation and compensation will also be required to address the impacts of expansion on local villages and communities. The number of homes lost at Heathrow differs depending on the option chosen, but in either case would be higher than required for a second runway at Gatwick. Each of the three schemes would also be likely to have some impacts on community facilities and heritage assets.
- 13.67** For those who would be directly affected by housing loss, statutory protection exists and both airports have proposed to offer more than the minimum requirement, compensating property owners at full market value plus an additional 25% and covering reasonable costs. For the wider community, the Commission's proposed noise levy would increase the level of long-term funding available to address local impacts, although it would need to be in addition to, and not a replacement for, an appropriate contribution from the airport's owners. The establishment of a statutory Community Engagement Board would also help to ensure that compensation and mitigation are delivered in a way which reflects the needs and priorities of those affected. These proposals are discussed in more detail in **Chapter 14**.
- 13.68** All three of the schemes under consideration would present other environmental challenges which would need to be managed through detailed design and mitigation. The Gatwick scheme would require the loss of a valuable area of ancient woodland. Both Heathrow schemes could have an indirect impact on the bird habitats in the South West London Waterbodies RAMSAR site. Each of the options would also affect flood risk. Overall, however, those issues are not considered to be unmanageable at either Heathrow or Gatwick.
- 13.69** In the Commission's view, the more substantial environmental and community impacts of expanding Heathrow compared to Gatwick need to be recognised and taken into account. There is significant scope, however, to reduce or offset many of

them through careful design and mitigation, and every opportunity should be taken to achieve this as any proposal for expansion is further developed. This would cover measures to reduce noise through operational practices such as respite and through careful flight path design, as well as measures to improve air quality around Heathrow and minimise the airport's impacts, potentially including the introduction of an access charge for those travelling to the airport by road or a broader congestion charge.

- 13.70** In addition, adding capacity at Heathrow would create opportunities to improve the noise environment and fundamentally alter the relationship between the airport and the communities which surround it. These would include the elimination of arrivals before 6:00am, the establishment of a statutory Community Engagement Board and the introduction of much more generous funding for community compensation through a noise levy.
- 13.71** The Commission's conclusion is that the environmental impacts of expansion at Heathrow, once effective mitigations and generous provision for compensation are in place, should not outweigh its very significant national and local benefits.

Commercial viability and resilience

- 13.72** Achieving the benefits which stem from expanding runway capacity is dependent upon the deliverability and resilience of the option taken forward. However strong its theoretical advantages, if a scheme cannot be implemented or cannot operate reliably, then it should not be recommended. The Commission's assessment of the three shortlisted options has therefore considered their commercial and operational viability, as well as the resilience of their surface access links and the challenges associated with their delivery. The conclusion is that they are all financeable, deliverable and resilient proposals. Each could be operational by the mid-2020s and able reliably to deliver benefits over the long term.
- 13.73** It is anticipated that all three options would be privately funded and delivered, so it is important that they are commercially viable and able to attract the investment needed for construction and operation. The Commission's commercial analysis indicated that each of the schemes would be likely to be a feasible commercial proposal given the strength of the aviation market in London and the continuing demand growth which is forecast over the long term, even when constraints on carbon emissions from aviation are taken into account. But each also presents commercial challenges. For the two Heathrow schemes, they relate principally to the scale of investment required. The Gatwick scheme is less costly than the

proposals at Heathrow, but the investment needed would be larger relative to its existing asset base and the growth of future demand at the airport is less certain.

- 13.74** Discussions with investors have suggested that all three shortlisted schemes are considered to be commercially viable proposals, although the demand risk associated with the Gatwick scheme is considered to be slightly more significant than the market capacity risks at Heathrow.
- 13.75** In operational terms, it is important that an expanded airport is able to operate resiliently and reliably, reducing delays for passengers and other users, and offers flexibility to respond to changes in the demands from airlines and their customers. All three schemes are assessed as being operationally viable and likely to deliver enhanced resilience at the expanded airport. The Heathrow proposals would provide greater flexibility, however, than expansion at Gatwick, where the design of the airfield with a second runway in place is structured heavily around the needs of the low-cost sector.
- 13.76** Resilience is also an issue in relation to surface access links. The motorway links and the central London sections of the rail lines serving Heathrow are forecast by 2030 to be extremely congested at peak times, which will increase the impacts of minor disruption, such as single-lane closures or cancellations and delays from signalling problems or leaves on the line. Gatwick is not as susceptible to these smaller events, but because it is heavily reliant on a single road and rail route, major disruptive events, such as the closure of the railway line to the airport due to a landslip, can have severe consequences for passengers. Expansion at Heathrow provides greater resilience in respect of this kind of major disruption, which is of most concern to passengers, because the many road and rail links serving the airport mean that alternative options are available when any one connection is suspended.

The best option for expansion at Heathrow

- 13.77** The Commission has set out above why it considers that expansion at Heathrow offers a stronger solution to the UK's aviation capacity and connectivity needs than a second runway at Gatwick.
- 13.78** In reaching that conclusion, the Commission has taken full account of the greater environmental impacts of expansion at Heathrow compared to Gatwick, but believes that with an effective package of mitigations and generous long-term provision for community compensation in place, as set out in the next chapter, these should not outweigh Heathrow's broader advantages.

- 13.79** There are, however, important differences between the two shortlisted options for expansion at Heathrow.
- 13.80** The proposal for extending Heathrow's northern runway (the scheme proposed by Heathrow Hub Ltd⁹³) offers two key advantages:
- Its estimated costs are roughly £3 billion lower than those of the Northwest Runway option, at £14.4 billion (plus £5.5 billion for surface access) compared to £17.6 billion (plus £5.0 billion for surface access). This would reduce the financing risk associated with the scheme and lower the increase in aeronautical charges paid by airlines using the expanded airport.
 - It would require the loss of only 242 homes compared to 783 for the Northwest Runway option. Its impacts on community facilities such as schools and health centres would also be significantly more limited, as would the potential loss of properties as a result of surface access works.
- 13.81** While these advantages are valuable, however, they must be offset against a number of other areas where the extended northern runway performs less strongly than the alternative option for expansion at Heathrow.
- 13.82** First, the Extended Northern Runway delivers a lower level of capacity than the Northwest Runway option, at a total of 700,000 air transport movements a year compared to 740,000. This leads to reduced passenger and wider economic benefits, a smaller route network at the airport, and a less significant impact on long-haul connectivity at the national level.
- 13.83** Second, the Extended Northern Runway option could only deliver runway alternation, which is highly valued by local communities, outside peak periods of operation, whereas the Northwest Runway would retain all-day runway alternation. The level of respite delivered in this way would reduce with the Northwest Runway from current levels – from half-day to a third of the day – but would be more reliable than with two runways (due to the greater resilience of the expanded airport). For either option, new approach and departure paths could enable noise impacts further from the airport to be dispersed more widely than at present.
- 13.84** Third, the Extended Northern Runway would continue to concentrate take offs and landings along just two approach and departure paths. In contrast, the Northwest Runway scheme would divide arrivals and departures across three runways over the course of the day, reducing significantly the size of the population within the

93 Not including the hub station concept, which the Commission considered separately but concluded should not be recommended (see Chapter 8).

highest noise contours. The population exposed to more than $63\text{dB}_{\text{L}_{\text{Aeq16h}}}$ with the Extended Northern Runway would be more than 25,000 higher in 2030 than with the Northwest Runway in place.

- 13.85** Fourth, the Extended Northern Runway presents greater challenges in terms of compliance with the EU Air Quality Directive. The different configuration of access roads under this option, together with the proximity of both sections of the intensively-used extended runway to the Bath Road, mean that the predicted exceedance at the Bath Road monitoring site is materially higher than from a new Northwest Runway. For the latter, the Commission has been able to identify and quantify mitigations which reduce the exceedance to below the highest level in the Greater London zone. On that basis, its impacts may be expected to be manageable when tackled alongside a strategy to address broader air quality issues at national and regional level. It has not been possible to identify similar mitigations for the Extended Northern Runway option and so it would be appreciably more risky to draw the same conclusion.
- 13.86** Fifth, the design of the Extended Northern Runway scheme creates a more congested airfield than the alternative option, as a result of having to squeeze a significant increase in movements into the confined space between the two runways. In contrast, the design of the Northwest Runway proposal materially increases the size of the airfield, providing new piers and stands between the current northern and new Northwest Runways. The greater capacity offered by three full-length runways also provides more resilience to manage airspace disruption, ensuring delays are minimised and improving the reliability of respite for local communities, and the airfield has more space for ancillary development, which could be used to expand the airport's on-site freight capacity.
- 13.87** On balance, taking account of its economic, environmental and social impacts, and operational and commercial factors, the Commission's judgment is that the Extended Northern Runway presents a less effective proposition to meet the UK's aviation capacity and connectivity needs. It has therefore concluded that the Northwest Runway scheme offers the best option for expansion at Heathrow.

Conclusion

- 13.88** The Airports Commission's recommendation is that the proposal for a new Northwest Runway at Heathrow Airport, when combined with the significant package of measures described in the next chapter to address its local environmental and community impacts, is the strongest option for expanding

aviation capacity, delivering the greatest overall benefits for the UK and striking the best balance between national and local priorities.

13.89 This view has been reached following a comprehensive and integrated assessment of social, environmental and economic impacts, and of commercial and operational viability, and a substantial process of consultation and engagement with interested parties on all sides.

13.90 The Commission's assessment has also incorporated a range of future outcomes for managing carbon emissions from aviation, including the operation of a global or European trading system (considered through the carbon-traded forecasts and analysis) and through approaches which do not allow for any increase above the Committee on Climate Change's planning assumption for aviation emissions.

13.91 In order to ensure that its recommendations are robust to the broadest spectrum of potential carbon futures, the Commission has also considered an extreme scenario in which the net economic benefits to passengers are reduced to zero. This would require any benefits from increased passenger numbers through the expanded airport to be entirely offset by disbenefits resulting from reductions elsewhere. Even in this context, however, expansion at Heathrow would be commercially viable and would deliver improved reliability and resilience and enhanced competition in the London airport system. It would support growth in air freight, improve access to London's international connectivity from the English regions and from Scotland and Northern Ireland, and, crucially, enable the UK aviation system to provide more long-haul connectivity, which will be crucial to the UK's prosperity in an increasingly integrated global economy. So even in this extreme scenario the Commission's judgement is that the strategic case would justify proceeding.

13.92 In reaching these conclusions, however, the Commission is acutely aware that expansion at Heathrow has been proposed previously and faced substantial opposition from environmental organisations, community action groups and elected representatives at the local and national level. This opposition reflects real and material concerns. A fundamentally different approach is needed if they are to be overcome.

13.93 That means focusing on the issues of most importance to local communities, such as tackling long-standing issues such as night noise and respecting the value placed on predictable respite by those close to the airport. Long-term funding for compensation and insulation must be available to provide certainty for those living under the airport's flight paths and local people should be given a real say in how the airport operates and how its impacts are managed and mitigated.

- 13.94** Any effective solution must also take account of the interests of those individuals and communities around Heathrow who are not opposed to expansion. Alongside the hostility to a third runway, the Commission's national consultation has demonstrated that there is also substantial support at the local level, which recognises the economic and employment opportunities that expansion would create. It will be vital to ensure that they are seized in delivering new capacity, by providing support for nearby businesses, training and apprenticeships for young and unemployed people in the local area, and access to the new jobs that will be created.
- 13.95** The Airports Commission believes that these are achievable goals. As well as supporting the economy in the surrounding area, expansion at Heathrow also creates the opportunity to address many of the most serious concerns of local communities. The package of measures for mitigation, compensation and engagement proposed by the Commission to accompany a new runway at Heathrow would do so, ensuring that local issues are not overridden or ignored. Specific recommendations are set out in detail the next chapter.
- 13.96** In summary, the Commission's view, reached on the basis of a collaborative and integrated assessment process covering a full range of environmental, social and economic impacts, is that the Heathrow Northwest Runway scheme offers the strongest solution to the UK's aviation capacity and connectivity needs. Accompanied by ambitious measures to address its local impacts, an expanded Heathrow can be a better neighbour for local communities than the airport is today, while delivering significantly enhanced connectivity and substantial long-term economic and strategic benefits for the UK as a whole.

14. Respecting the Needs of Local Communities

Introduction

- 14.1** Expansion at Heathrow Airport should be taken forward as part of a broader package that addresses the environmental, social and economic impacts in a way that both supports the national interest and recognises the needs of local people.
- 14.2** This will mean a significant shift from ‘business as usual’ thinking for the airport, its local communities and the Government. Expanding Heathrow provides an opportunity to change the way the airport operates. The additional income generated as a result of operating a third runway should be allocated in a new way and the airport should be obliged to develop a new and more collaborative relationship with its local communities, as some overseas airports have succeeded in doing.
- 14.3** Airport expansion would bring new prosperity and opportunities for many, but also unwelcome impacts for those affected by noise and other environmental factors and most particularly for those who will have to relocate their home or business to make way for an enlarged airport.
- 14.4** The Commission’s terms of reference required it to consider the social, environmental and economic impacts of the shortlisted options and to make recommendations on the optimum approach for meeting the UK’s aviation capacity and connectivity needs. It was also tasked with making recommendations for ensuring those needs are met as expeditiously as practicable. Respecting the needs and concerns of the communities close to the airport chosen for expansion will play a crucial role.
- 14.5** The Commission published a discussion paper (*Discussion Paper 07: Delivery of new runway capacity*) in July 2014 to which a wide range of responses were received, and it sought views on how the shortlisted schemes could be improved, including through mitigation and compensation, as part of its more recent consultation.

- 14.6** It engaged widely throughout its process, inviting elected and unelected community representatives to speak at its public evidence and discussion sessions and visiting communities around Heathrow and Gatwick. It held meetings with a wide range of stakeholders including community groups and has considered the arguments put forward by knowledgeable local campaigns, which have made a number of constructive proposals, as well as the concerns of the aviation industry, customer representatives and other organisations.
- 14.7** Alongside its recommendation that Heathrow is the best location for additional runway capacity in the UK, the Commission also makes a number of important recommendations on how new capacity should be developed best to meet the needs of local communities. The Commission recognises that for some people airport expansion will be unwanted. As evidenced by consultation responses, there are also many others who live and work under Heathrow's flight paths who acknowledge the benefits the airport brings, but strongly believe it has not been a 'good neighbour' in the past, and could do much more to minimise the adverse impacts its operations have on local people. They also point to a record of undertakings and promises not fulfilled and a lack of trust between the airport and its local communities.
- 14.8** The Commission acknowledges these strongly felt concerns. Its package of recommendations, including new consultation mechanisms, far higher compensation and a legislative prohibition on further runway development, are designed to offer reassurance that the future will be different.

Limiting the impacts of noise

- 14.9** Technological advances have greatly reduced the noise produced by aircraft and there is good reason to expect a continuation of this trend in the future. A new runway at Heathrow will also enable many aircraft to be re-routed over less densely populated areas. Nevertheless, aviation noise will clearly have a significant ongoing impact on people's health and wellbeing. In response to the consultation, many people provided submissions setting out how aviation noise affects them and their concerns that forecast improvements in aviation noise from new technologies or operational changes may be exaggerated or may never materialise.
- 14.10** The Commission believes that expansion must be taken forward with a firm guarantee that the airport and its airlines will be held to the very highest standards on noise performance. It should be the airport that pays the price if it does not keep its promises and not local communities. In addition, Heathrow Airport should not be allowed to expand without appropriate conditions being put in place in respect of its

noise impacts and a fairer balance being struck between the needs of the airport's customers and its local community.

14.11 Our recommendations for how to achieve this are set out below:

Clear noise performance targets (a noise envelope) should be agreed and Heathrow Airport Ltd must be legally bound to stay within these limits.

14.12 There are a number of ways in which airports can work with airlines to reduce noise at source:

- The routes which aircraft fly on landing or departure determine where noise is produced. Flying over less densely populated areas can reduce the number of people affected and routes can be alternated to provide periods of respite for residents.
- Steeper descents can enable aircraft to fly higher for longer, reducing noise impacts on the ground. Displaced thresholds (having planes land further down the runway) can also achieve the same end.
- Keeping landing gear up as long as possible and limiting sharp turns will reduce the noise a single aircraft produces.
- New technologies can reduce the amount of noise aircraft produce. In particular, new aircraft typically produce less noise than previous generation models.
- Airports can work with airlines to ensure that they have clear incentives to optimise their noise performance. This can include financial incentives such as fines for not flying to agreed routes.
- The noise impacts of an airport can be reduced by limiting the amount of traffic it serves. Several UK airports have limits on the number of passengers or flights that are allowed. This can include stricter limits during more noise sensitive periods, such as during the night.

14.13 Heathrow Airport Ltd (HAL), in tandem with its airline customers, must have a clear incentive to pursue these strategies. The Commission believes that setting a 'noise envelope' for expansion is the best way to achieve that while giving communities reassurance on future noise impacts.

14.14 A noise envelope is a restriction on the amount of noise produced at an airport. Capping the level of noise allowed ensures that the airport and airlines must become more noise efficient if the airport is to grow. As set out in **Chapter 9**, there are a number of ways in which noise can be measured and consequently a number of ways in which an envelope could be set:

- The physical area of particular noise contours. The Commission has considered a number of average noise level contours at different times of the day and night as well as number above contours which track the number of events above a particular noise level. Any of these or a combination could be used.
- The number of people within a particular noise contour or group of contours. As above there are several options. Tracking the number of people affected instead of the physical area makes the envelope sensitive to changes in population density. This ensures that the social impact of noise is more closely tracked but also introduces factors such as housing growth over time that are outside the airport's control.
- A points-based system in which individual aircraft are rated by their noise impacts.

14.15 It is also possible to use the number of passengers or air transport movements (ATMs) as a proxy measure. While this has the advantage of being clear and easy to understand, using a proxy of this kind does not necessarily give airports or the airlines using them an incentive to reduce noise.

14.16 Existing noise envelopes are based on a combination of factors. As part of its agreement on a second runway, Manchester Airport reports the area and population contained within its daytime and nighttime 60dB L_{Aeq} contours and guarantees that the areas will not be larger than in 2001. In addition the average level of noise of the loudest 10% of departures (over a 24-hour period) must remain lower than that in 2001; and the average level of noise for the 100 loudest departures during the daytime and nighttime, separately, must remain lower than those in 2001. At Stansted Airport, planning conditions restrict annual air transport movements to 264,000, passenger numbers to 35 million passengers per year and the area within the 57dB L_{Aeq16h} contour to 33.9 km².

14.17 As these examples illustrate, a noise envelope can be a complex and precise tool and can be designed to reflect different local noise priorities. There is a risk that over-complexity can make a noise envelope difficult for people to understand and trust. The Commission has recommended the establishment of an independent aviation noise authority that would provide impartial expert advice and help

communities and airports to agree noise management strategies which could make this process easier and more accessible. See paragraphs 14.94-14.105 below.

- 14.18** It would be possible to agree a noise envelope for an expanded Heathrow that would ensure that the total number of people affected by noise under expansion would be no higher than it is today. This would be achieved by ensuring that the approach and departure routes for aircraft using the expanded Heathrow Airport avoided the most densely populated areas, with the position of the new Northwest Runway helping to facilitate that. Alternatively, it may be that routes which minimise the number of newly affected people or which offer maximum alternation to maximise periods of predictable respite, or indeed a combination of these factors, would be preferred. For this reason, the exact details and design of a noise envelope should be for local agreement. That will require effective local engagement, independent monitoring and assurance and firm legal foundations, as discussed later in this chapter.

A third runway would create the opportunity to end night flights before 6:00am. This opportunity should be taken. Following construction of a third runway at Heathrow there should be a ban on all scheduled night flights between 11:30pm and 6:00am.

- 14.19** Under current arrangements a quota system limits the number of flights that use Heathrow during the 'core' night period from 11:30pm to 6:00am. This has restricted flights in this period to an average of 16 arrivals per night and no departures. All of these arrivals are scheduled between 4:30am and 6:00am. After 6:00am the number of arrivals and departures increases.
- 14.20** As underlined by consultation responses, flights during the night are very unpopular with local residents. The Commission analysed the noise contours and numbers of people affected during the full 8 hour night period (11:00pm to 7:00am) and published these data for consultation. It also published an assessment of the level of high sleep disturbance (HSD) resulting from this noise, using World Health Organization (WHO) methodology, and monetised the impact for each of the shortlisted schemes. Monetised HSD is not the only potential impact of night noise, with impacts on workers' productivity and children's learning also cited by stakeholders.
- 14.21** In response to consultation responses, additional analysis of the health impacts of noise was commissioned, including work to consider the impacts of shortlisted schemes with night flights during the core 6.5 hour period or the full 8 hour night

period removed. This analysis is presented in full in the Commission's technical reports (*Noise: Local Assessment Compendium of ANCON Modelling Results*) and in summary below with **Table 14.1** presenting the impacts on sleep disturbance.

14.22 These figures do not represent a definitive assessment of the health impacts of any potential night flight restriction policy for any shortlisted scheme. Such impacts are dependent on how airlines react and how, whether and to what extent flights are rescheduled.⁹⁴ This analysis makes no assumptions on rescheduling, but simply removes the relevant flights for illustrative purposes only.

Table 14.1: Monetised sleep disturbance: incremental difference compared to do minimum, £ million/year⁹⁵

	2030	2040	2050
Heathrow Northwest Runway ⁹⁶	9.6	3.40	-25.6
Heathrow Northwest Runway no core night flights (11:30pm-6:00am)	-37.1	-35.9	-74.1
Heathrow Northwest Runway no night flights (11:00pm-7:00am)	-198.2	-293.3	-261.6

Note that a negative figure is a reduction in the monetised impact, and hence an improvement in the noise environment, compared to the do minimum (i.e. the forecast impact without airport expansion).

Source: CAA analysis

14.23 At the same time, the transport benefits of existing night flights at a currently capacity-constrained Heathrow are clear. Arrivals within the restricted core night period (before 6:00am) are broadly used to support connectivity to high value long-haul destinations. As the aggregate data for 2014 illustrates, these slots currently play an important role in maintaining connectivity with key destinations. For example, more than half of the capacity for arrivals at Heathrow from Hong Kong and Singapore is currently scheduled during the core night period, as shown below.

94 It should be noted that the WHO methodology assumes that all HSD occurs in the full 8hr night period and that, in that period, each hour counts equally. As such, if any night flight restriction resulted in rescheduling during this period, including from the middle of the night to the early morning or end of the previous day, its impact would not show in this analysis.

95 Summary table shows particular assumptions on health impacts. The full range of alternative assumptions is included in the technical report.

96 Assumes continuation of current nighttime restrictions. This is in line with scheme promoter proposals.

Table 14.2: Core (11:30pm to 6:00am) night flights with more than 10,000 seats annual scheduled capacity at Heathrow Airport 2014

Arrivals	Total number of seats scheduled on core night flights	Core night flights as a % of the total scheduled seat capacity (day and night) at Heathrow for that route
Hong Kong	480,755	53%
Singapore	387,319	52%
Kuala Lumpur	180,310	50%
Johannesburg	158,264	28%
Nairobi	123,858	54%
Lagos	109,021	34%
Riyadh	107,483	51%
Dubai	69,489	4%
Chicago	67,664	9%
Cape Town	55,487	24%
Boston	45,540	8%
Accra	41,758	32%
Jeddah	22,853	12%
Total	1.85m	

Source: CAA analysis of OAG data⁹⁷

- 14.24** In response to consultation, several airlines highlighted the attractiveness of an overnight service to their customers with evening departures from places such as Hong Kong, Singapore or Johannesburg arriving in London in the early morning. Freight users also highlighted the value of these services to their businesses.
- 14.25** The Commission considers that it would not be feasible to impose further restrictions on night flights at a capacity-constrained Heathrow without causing significant damage to the UK's international connectivity. So it recommends that the current allowance be maintained in advance of any airport expansion. There would be a powerful economic and commercial argument for increasing the core night flight quota in the longer term if Heathrow Airport is not expanded and remains capacity-constrained.

⁹⁷ OAG data represents the schedule for the day, not the actual flights and times performed and includes passenger flights only. Core night flights are defined through the scheduled stand time as reported by OAG with an adjustment of 20 minutes assumed to allow for taxiing.

- 14.26** However, the addition of a new Northwest Runway at Heathrow from the mid-2020s would fundamentally alter the picture. The additional capacity it would provide in the period from 6:00am (which currently constitutes a peak period for operations and therefore sees all available slots utilised) could enable airlines to re-time very early morning arrivals to a less disturbing time for local residents but one which remains attractive to customers – an option not currently open to them without cancelling other services.
- 14.27** It is the Commission’s judgement that successful retiming of flights out of the core night period (before 6:00am) within an enlarged airport is credible. There are a number of reasons for that conclusion.
- 14.28** The example of passenger services at Frankfurt Airport following a ban demonstrates the adaptability of airlines. In 2012 the airport implemented a ban on night flights between 11:00pm and 5:00am which had been imposed by the courts. Until that time the airport had been operating flights during the curfew period on around 40 major routes. Night flights were mostly short-haul, although with some long-haul, and included arrivals and departures. Following the ban, capacity on these routes increased in aggregate at about the same rate as the rest of the airport’s operations. That is to say on average the number of additional seats provided outside the curfew period was greater than the number lost. It should be noted that even after the ban, Frankfurt Airport was and is able to operate unrestricted from 5:00am. The scale of scheduled seat capacity that was affected by the curfew (0.9 million over the summer 2011 period) is broadly comparable to that provided in Heathrow’s core night period (1.85 million over a full year).
- 14.29** A review of existing schedules at Heathrow suggests that there would be no insurmountable demand or supply-side barriers to providing alternative overnight services to arrive after 6:00am:
- Of 13 arrival routes in the core night period with a scheduled capacity of more than 10,000 seats in 2014, 11 were also served by an arrival between 6:00am and 8:00am.
 - Of the two remaining routes (Lagos and Kuala Lumpur) there is currently no operating curfew at the originating airport that would prevent a later departure and arrival.
 - Additional capacity from a third runway could support around 40 additional movements per hour in this period which could be used to accommodate retimed flights, whilst still allowing scope for growth.

- The majority of passengers on arrivals in the core night period are origin and destination passengers for whom a slightly later arrival would be unlikely to be a cause not to travel. Travelling via a rival European hub would remain a longer and less attractive option.
- Transfer passengers (those arriving at Heathrow to transfer to another flight) make up on average around 37% of passengers on core night arrivals. For some of these passengers there may be a quicker option via an alternative hub airport, but this will only be relevant to the most time-sensitive customers within a relatively small transfer window for whom arrival at Heathrow before 6:00am is necessary to achieve their final arrival time.

14.30 Nonetheless, the Commission recognises that the removal of core night flights would have some disbenefits:

- It is probable that some, but by no means all, transfer passengers may choose to fly via an alternative hub airport, reducing business on affected inbound and outbound flights at Heathrow.
- A later arrival and departure time, even if only by up to 90 minutes, may be less convenient for some passengers and freight users (a later arrival time would not necessarily equate to a longer journey time).
- There would be a very small reduction in the total capacity available at the airport (less than 1%) that would have an effect in later years when demand begins to reach peak capacity. Demand for peak time arrival slots would increase more quickly.

14.31 Such a change is likely to be unwelcome to airlines currently operating in these slots. However, it is important to remember that any removal of core night flights can, in the Commission's view, only be facilitated by airport expansion and so could not occur for several years, giving affected airlines time to plan and prepare for the change. In the interim period current operations should be maintained. In addition, it is expected that under the current European regulations on slot allocation, retiming of these historic slots would take precedence over the allocation of new slots at an enlarged airport once operational.

14.32 For others the removal of core night flights before 6:00am will not go far enough. A number of stakeholders have called for a wider ban to include flights before 7:00am. Having considered this proposal, the Commission does not recommend a ban between 6:00am and 7:00am. This is because:

- A large number of services would need to be retimed. For Heathrow's current schedule this would be more than 80 movements including arrivals and departures. Even with the additional capacity from a third runway it would be unlikely that all services could be accommodated at peak hours and also provide for growth; and
- Heathrow would be at a significant time disadvantage compared to other European hubs whose first flights of the day would be up to 3 hours before their UK equivalent in real time.⁹⁸ That could make Heathrow significantly less attractive as a hub.

14.33 These supply and demand-side factors would be likely to cause significant impairment of international connectivity and capacity.

14.34 Nonetheless, it is important for the airport to maximise noise reduction strategies during the early morning such as the use of displaced thresholds and incentivising the use of quieter aircraft. Local communities and the airport may in cooperation wish to prioritise noise insulation or compensation for those affected by noise in the early morning, as discussed later in this chapter.

14.35 Having considered all of these arguments and the evidence presented to it, the Commission recommends that following construction of a third runway at Heathrow there should be a ban on all scheduled night flights between 11:30pm and 6:00am at the airport.

14.36 A ban should not preclude the use of the runway in a genuine emergency and a common sense approach should be taken to policing any infringement. If in practice the ban is not properly observed, however, harsher enforcement measures should be used.

A third runway should allow periods of predictable respite to be more reliably maintained. Heathrow Airport Ltd should work with local communities to determine how respite should best be provided.

14.37 Knowing that aviation noise will be limited to certain times of the day is very important to many people. Heathrow currently practises runway alternation, using one runway only for arrivals and one only for departures and swapping over at 3:00pm each day. This ensures that communities have regular periods of relief from being overflowed.

⁹⁸ The UK's use of Greenwich Mean Time (GMT) puts its airports at a competitive disadvantage in this respect. For example 5:00am local time in Frankfurt is 4:00am GMT.

- 14.38** Although a third runway at Heathrow would reduce respite for any individual community enabled by runway alternation from roughly a half to a third of the day, the Heathrow Airport Northwest Runway proposal would enable respite from runway alternation to be more reliably maintained by improving the resilience of the airport.
- 14.39** Because the airport is currently operating at maximum capacity, delays due to poor weather or other factors can require it to compromise respite periods in order to clear a backlog of arriving and departing flights. For example, under certain prescribed conditions, Heathrow Airport can currently use both its runways to land aircraft for a short time. This is known as Tactically Enhanced Arrival Management (TEAM). In the 2012 summer season and 2012/13 winter season, TEAM was used almost every day to manage arrival queues. This reduced respite for those living under particular flightpaths who would not be expecting to be overflown on that morning. The increased capacity from three runways will enable the airport to operate more robustly in this regard, limiting the use of these procedures.
- 14.40** It is also possible to alternate flight paths so that planes using the same runway follow different routes and so have different noise impacts. In theory, several alternative flight paths could be flown, although the challenge of designing and operating any system increases with its complexity. Each aircraft's final approach must also be in a straight line for safety reasons. Airspace alternation may complement runway alternation in improving periods of predictable respite and merits further consideration on these grounds, but would not benefit those closest to the runway for whom runway alternation is still required.
- 14.41** There are many decisions to be made about how respite is best maintained and how this is balanced against other environmental priorities such as limiting the total number of people affected at different noise levels. Local communities should be engaged in a more equal and collaborative dialogue on how best to manage the impacts of airport expansion. Paragraphs 14.83-14.93 below explain how a dedicated Community Engagement Board and an independent aviation noise authority can help to facilitate that.

Improving compensation

- 14.42** Even with the best mitigation in place, airport expansion will have unwelcome impacts for many local people, including those who need to relocate homes or businesses to make way for development. For these people, effective compensation arrangements are vital.

Blight

- **Heathrow Airport Ltd should honour the commitment it has made to compensate those who would lose their homes at full unblighted market value plus an additional 25% and reasonable costs and it should make this offer available as soon as possible.**
- **Heathrow Airport Ltd should engage with local businesses to ensure that they are fairly compensated for any disruption.**
- **A Community Engagement Board may act as advocate for potentially displaced residents and businesses who are concerned about the offer available to them and provide help and advice.**
- **Heathrow Airport Ltd's offer to purchase residential property within a wider area at the same rate is a positive step and should be made available for those who wish to take it up. Re-letting or reselling of any such properties should be sensitive to the needs of the wider community.**
- **Heathrow Airport Ltd should work with Government and local communities to determine appropriate support for those who may face exceptional hardship if they are unable to move because of uncertainty over expansion.**

14.43 Those closest to the airport boundary and whose homes or businesses would need to be compulsorily purchased to enable development should be appropriately compensated. In law, a developer must purchase property for its full unblighted value (that is the full value of the property without any negative impact from the proposed development). Heathrow Airport Ltd has proposed that it would purchase residential property at a higher level (full unblighted market value plus an additional 25% and reasonable costs). This is significantly above the statutory minimum and also exceeds the offer made by the Government for those who face losing homes to HS2.

- 14.44** The Commission is aware from consultation responses that moving home in enforced circumstances can be a cause of stress and concern. A number of responses to the consultation highlighted the need to ensure that displaced residents were able to move to an 'equivalent' home. For these reasons compensation for people should be made available as soon as possible to counteract uncertainty and to ensure that residents have some years to plan and prepare and to choose where and when to move before a Compulsory Purchase Order (CPO) is served. It is also important that help, advice and advocacy is made available for affected people within the community. The Commission believes that a dedicated Community Engagement Board could help. This is discussed in more detail at paragraphs 14.83-14.93 below.
- 14.45** Heathrow Airport Ltd should make its compensation offer available if and when the Government decides to accept the Commission's recommendations.
- 14.46** The level of statutory protection for businesses facing a potential CPO is different from that for residential property owners. Nevertheless, it would be good practice for Heathrow Airport Ltd to engage early and voluntarily with affected businesses to address their concerns.
- 14.47** Outside of the immediate CPO zone, there will be residents who may be prevented from selling their homes whilst the airport development is moving through its planning and construction stages. Heathrow Airport Ltd has proposed to extend its 125% plus reasonable costs purchase offer to a number of communities, including Poyle, Colnbrook, Brands Hill, Harmondsworth, Sipson, Harlington and Cranford Cross, which would make the scheme available for up to 3,750 households. That would be an entirely voluntary offer. If any resident wished to accept, his or her property would be purchased and fully noise insulated by HAL before being made available for resale. This offer is a positive step. If necessary HAL should also work with government and local communities to ensure that suitable arrangements are put in place to support any genuine cases of exceptional hardship across a wider geographical area.
- 14.48** When returning such properties to the market, it will also be important to consider the wider social and economic impacts on communities. For example it may be appropriate for the airport to work with local authorities and housing associations to retain or improve provision of good quality affordable housing in the area or to support the cohesion of local communities and access to services and public amenities.

Wider Community Compensation

- **Heathrow Airport Ltd's proposal to spend more than £1 billion on community compensation, including £700 million on noise insulation is welcome. HAL should be held to this commitment.**
- **The wider community package should include significant levels of investment in noise insulation and other support for schools as a priority.**
- **Heathrow Airport Ltd should also be prepared to go further if it is to demonstrate a genuine commitment to a world-class compensation package that matches the scale of its business ambitions. That should include working more collaboratively with local communities to identify priorities for compensation and supporting efforts to ensure that those who benefit from expansion also make a fuller contribution to compensating those who endure the noise and other consequences.**
- **The Government should introduce a noise levy or charge at major UK airports to ensure that airport users pay more to compensate local communities. A levy should not impose undue or unfair costs at any airport.**
- **Air Passenger Duty is an important feature of a sustainable aviation sector in which those benefiting directly make a contribution to wider society benefits.**
- **Increased business rates revenue from airport expansion should be retained locally and distributed fairly across the affected areas.**

14.49 The impacts of expansion, particularly environmental factors such as noise, will spread over a wider area than just the airport's immediate vicinity. It is right, therefore, that Heathrow Airport Ltd's compensation offer is similarly broad. Whilst developers have statutory duties to provide specific mitigations or compensation in certain circumstances, it is good practice and socially responsible behaviour for developers to make a wider compensation offer in discussion with local communities and authorities.

What is the difference between mitigation and compensation?

Terms such as ‘mitigation’ and ‘compensation’ can mean different things to different people. Broadly ‘mitigation’ refers to activity that seeks to reduce a harmful effect or its impacts, whilst ‘compensation’ seeks to redress the harm done. The provision of noise insulation for buildings could have a mitigating effect by reducing the disturbance caused but also a compensatory element by for example reducing heating bills.

- 14.50** Heathrow Airport Ltd (HAL) has proposed to invest £700 million in noise insulation, benefiting 160,000 households, alongside making an increased contribution to community infrastructure. The Commission has considered a number of international and cross-sector examples of community compensation packages attached to infrastructure development and recommends that an open and collaborative approach is taken to agreeing the exact details of any such wider compensation package. HAL has consulted on its compensation proposals and amended them in response. Nonetheless, a dedicated engagement board could help to ensure a more equal and engaged relationship between the airport and its community in agreeing priorities for compensation. HAL should continue to work more collaboratively with local communities to identify and agree priorities for community compensation.

Examples of wider community compensation

- Amongst Manchester Airport’s community commitments is sponsorship of arts and culture in its region. Since the arts sponsorship programme began, more than £8 million has been allocated to a range of projects.
- The Government’s approach to HS2 has included cash payments to householders outside the compulsory or voluntary purchase zones and up to 300 metres from the line in rural areas, with payments between £7,500 and £22,500 for those residents.
- The Government’s strategy for community energy includes a commitment for local people to be able to share in the benefits of development. One example, the Grange Wind Farm in Lincolnshire, operates a fund which provides financial support to community-based projects with an educational, environmental or social emphasis. The fund is administrated by the Lincolnshire Community Foundation and allocation decisions are made by a panel of local people.

- 14.51** The wider community package should include as a priority significant investment for schools in noise insulation and other support.
- 14.52** Noise insulation is already a feature in a number of schools near to the airport and high quality insulation of school buildings and the construction of outdoor adobe learning pods illustrate the potential for mitigation to improve the learning environment. In the event of expansion the package of support for schools must be world-class. Schools newly impacted by aircraft noise should have all noise mitigation installed before the runway is operational and funding for the ongoing running and maintenance of noise reduction measures (such as air conditioning that allows noise insulating windows to be closed on hotter days) should be provided. In addition any consideration for a new school in the area around the expanded airport should utilise the expertise of the independent aviation noise authority to understand the potential impact of aviation noise, so that this may be balanced against other considerations on where it should be sited.
- 14.53** In total, the Commission recommends that development of an additional runway at Heathrow is accompanied by a world-class community compensation package. Heathrow Airport Ltd (HAL) has proposed to spend more than £1 billion on community compensation attached to airport expansion, this is a notable increase on current levels and the airport should be held to this commitment. Nonetheless the Commission believes that the airport must be prepared to go further if it is to demonstrate a serious commitment to being a better neighbour and delivering a compensation package that befits an airport aspiring to be number one in the world.
- 14.54** Indicative analysis produced by the CAA demonstrates how HAL's proposals compare to other international examples:

Table 14.3: Comparison of historic airport spend on compensation and noise mitigation as part of airport expansion with Heathrow Airport Ltd (HAL) proposals⁹⁹

Airport	Period of spend	Implied annual spend per passenger in final year	Implied annual spend per person within the 55dB L _{den} contour in final year	Approx. annual spend
Sydney	2001 – 2002	£0.76	*	£18.9m
Amsterdam Schiphol	1984 – 2005	£0.73	£762	£33.3m
Heathrow (HAL proposal)	Assumed 2020 -2040	£0.45	£94	£58.0m
Frankfurt	2001 – ongoing	£0.40	£102	£24.3m
Chicago O’Hare**	1995 – 2014	£0.35	*	£24.6m
Madrid Barajas	1998 – 2013	£0.22	£220	£8.9m
Paris CDG**	1995 – 2008	£0.20	£63	£11.0m
Bangkok	2006 – 2011	£0.13	*	£6.2m
Heathrow (historic)	2007 – 2011	£0.09	£8	£6.2m

* data not available

** does not include additional investment funded through dedicated tax

Source: CAA analysis

14.55 The Commission believes that it is right that those who benefit from airports should meet the costs of compensating those who suffer the disbenefits. In particular the airport’s passengers and freight users must contribute through the charges they pay, including fares, taxes and other charges.

14.56 There are international examples of dedicated taxes or charges paid by airport users that support community compensation:

- In France, the Tax on Air Transport Noise Pollution (TNSA) was announced in 2003 and came into effect in 2005. The tax affects all aerodromes with over

⁹⁹ This is an indicative analysis only, and intended to allow a high level comparison of different airports. It should be noted that the Heathrow historic data was not connected with a consented expansion scheme. The analysis is also sensitive to the assumptions used. These include the fact that the annual spend represents funding allocated evenly across the historical or forecast period of spend; and that the number of people in the 55dB L_{den} contour is based on the final year of the investment period for historic examples. The calculations for the HAL proposal are based on the Airports Commission’s *assessment of need* carbon-capped scenario for expansion and all figures are in 2015 prices. Historic examples have been indexed using the mid-point of the period as a proxy for whole. Spend does not include statutory requirements for purchasing of land or property.

20,000 large aircraft movements annually. In 2010 it raised just over €58 million. The tax is set at a level which varies depending on the size of population affected by the aerodrome and on aircraft take-off weight, noise rating and time of day. Affected aerodromes collect the tax on the state's behalf, charging airlines as an element of their landing charges. Receipts from the tax are ring-fenced to fund neighbourhood improvements in the vicinity of the airport and noise mitigation works.

- In the USA, the Federal Aviation Administration (FAA) Passenger Facility Charge is levied on passengers and is used to fund a range of FAA approved projects and services including noise insulation schemes. The charge is set at up to \$4.50 per passenger. The FAA also provides grants through its Airport Improvement Programme for the planning and development of noise compatibility projects around individual airports. This funding is supported by user fees, fuel taxes, and other similar revenue sources. Around Chicago O'Hare Airport over \$550 million has been invested, insulating nearly 10,000 homes and more than 100 schools.¹⁰⁰

14.57 The Commission recommends that the Government should introduce a similar charge in the UK, which would further incentivise airports to reduce noise and ensure that they make an appropriate contribution to local communities.

14.58 A noise charge or levy should be based on the following principles:

- **Fairness** – the amount levied at airports must be proportionate to their noise footprint. This would mean that, for example, a charge that raised around £50 million per annum at Heathrow may only total £800,000 per annum at Gatwick.¹⁰¹
- **Localism** – all funds raised should be spent within the locality of the airport at which they are levied. There should be no cross-subsidy between airports.
- **Affordability** – a charge should not place an unaffordable burden on passengers or freight users or any particular airport. For example at Heathrow a charge that averaged around 50p per passenger would raise more than £50 million a year of additional funding for community benefits. A proportionately equivalent charge, one that raised the same amount per resident affected, at Gatwick or Stansted

100 http://www.oharenoise.org/about_us.html

101 Based on the assumption that the amount raised per resident in the 55dB L_{den} contour in 2030 is the same in both cases. This is an illustrative example and it would be for the Government and an independent aviation noise authority to determine the exact weighting mechanism.

may only cost around 2p per passenger because of those airports' smaller noise footprints.

- **Transparency and Value for Money** – an independent aviation noise authority should advise on the exact design and weighting of a charge and provide guidance or direction on how funds raised are most fairly allocated with regard to noise impacts. This may include an assessment of pre-existing arrangements at different airports. Local people should be able to see clearly how funds are used in their local areas and should have real influence over how money is spent.

- 14.59** The Government should determine the scale and structure of the noise levy in line with these principles. Any funding for communities raised by a noise levy should be in addition to the commitments made by Heathrow Airport Ltd. Whilst funds are raised in recognition of noise impacts, the Commission believes that it would be appropriate for funding to be able to be allocated to a wide range of community mitigation or compensation measures and that a dedicated Community Engagement Board should ensure that residents around Heathrow are able to influence how money is spent. The role of the engagement board is discussed in more detail at paragraphs 14.83-14.93 below.
- 14.60** The CAA in its consultation response proposed that additional revenues from Air Passenger Duty (APD) at an enlarged Heathrow or Gatwick could be hypothecated or ring-fenced to fund additional compensation and support for local communities. The Commission has considered this proposal and recognises that it could be an alternative means to the same end as a noise levy or charge. There would need to be some adjustments made, for example it is likely that only a portion of the revenue would be needed and current charging criteria for APD do not align perfectly to noise impacts. A new levy would have the advantages of being designed for purpose and of demonstrating a clearer commitment.
- 14.61** More generally, the Commission recognises the role played by APD, which currently raises about £3 billion a year, including the recent removal of the tax for children and decision to devolve APD in Scotland to the Scottish Government. APD in Northern Ireland is already devolved. The Commission is also aware that the tax is unpopular with airlines.
- 14.62** Nonetheless it considers APD to be a valuable feature of a sustainable aviation industry in the UK. APD has the potential to be an important demand management tool that may be used by future governments, including devolved administrations, to ensure that the UK meets its commitments on aviation emissions. Although not targeted specifically at emissions, the tax is also a means by which consumers

currently make a contribution to offset the social and environmental impacts of their aviation choices and it is noted that airlines do not pay VAT or fuel duty on aviation fuel.

14.63 Airport growth will also lead to increased business rate revenues collected by local authorities. Heathrow Airport Ltd currently pays £130 million per annum to Hillingdon Borough Council and the airport also directly and indirectly supports a number of rate-paying businesses in the wider area. Reforms in the last parliament have ensured that local councils have greater incentive to enable and support growth in their areas, with a proportion of any additional business rates revenues they collect being kept by the local authority.¹⁰² It might be expected that expansion at Heathrow Airport could see a high level of additional funding each year from business rates being used to support local public services and amenities or hold down other local taxes such as council tax.

14.64 In addition, the Government has shown a willingness to support even greater localisation of business rates in certain circumstances. For example it has proposed that all of the additional business rate revenue raised from hydraulic fracturing (fracking) developments are retained locally. The Commission recommends that the Government consider extending greater localisation of business rates in the case of airport expansion at Heathrow. It will need to assess how the social impacts of expansion as well as its positive and negative impacts on business rate revenues will play out across local authority boundaries. Local authorities can already voluntarily pool business rates to support cross border development. The Government may wish to see appropriate cross local authority border agreements put in place if it is to support greater localisation of those revenues.

102 The remainder is pooled centrally and redistributed to local authorities on the basis of assessed need.

Helping local economies to thrive

- **Airport expansion will support thousands of new jobs. Heathrow Airport Ltd should work with local authorities and schools to ensure local people, including young people, are able to benefit from this opportunity and should support the London Living Wage.**
- **Growth in jobs could increase demand for local housing and related community infrastructure. Heathrow Airport Ltd should build on existing commitments to support sustainable development of communities over several years. Local planning authorities should support sustainable development through more integrated joint planning across boundaries.**
- **Heathrow Airport Ltd should be held to performance targets to increase the percentage of employees and passengers accessing the airport by public transport, reducing pressure on local roads and air quality.**
- **The introduction of a congestion or access charge scheme should be considered to help ensure that road traffic to and from the airport does not cause unacceptable impacts on local air quality or road congestion.**

14.65 Expansion at Heathrow would provide jobs which people in the local community could fill, and drive wider economic growth in the areas which surround it. A number of respondents to the Commission's consultation have, however, also raised concerns about whether economic benefits will be shared with local communities and whether the impacts of realising economic growth such as increasing demand for skilled labour, local housing and transport can be accommodated. It is important that local people share in the prosperity which an expanded airport will bring and that the local economic impacts of airport growth are managed sensitively and effectively.

Education and training

14.66 Heathrow Airport is central to the economy of West London, currently supporting around 110,000 jobs. More than 65,000 people are employed directly at the airport with others dependent on the airport, its services and the business opportunities it generates. The airport supports jobs in a number of local communities and has a higher than the national average proportion of black and minority ethnic employees. Expansion at the airport could support 60-70,000 additional direct, indirect and induced jobs, which represents a significant opportunity for local people and businesses.

- 14.67** It will be important that local people, many of whom may currently still be of school age, are able to take advantage of new employment opportunities that result from expansion. Heathrow Airport Ltd has undertaken to double the number of apprenticeships to young people that it supports to 5,000. The airport's existing Community Fund provides £2 million per annum to support jobs and skills training for local people. Investment in a skilled local workforce is in the interests of the airport as well as its local community and current commitments are a good starting point for an ongoing and growing relationship. For example, Heathrow Airport Ltd could follow the example of Manchester Airport in proactively engaging with local schools and colleges to support and encourage students to apply for jobs.
- 14.68** The Commission also considers that to develop further its reputation as a good local employer Heathrow Airport Ltd should adopt the London Living Wage and demonstrate leadership on this issue across the sectors it supports.

Housing and local infrastructure

- 14.69** Airport growth and the jobs it would create could strengthen the demand for local housing and related public amenities. In recognition of this, Heathrow Airport Ltd has set out plans to commit more than £100 million to local areas through Community Infrastructure Levy payments and Section 106 agreements. These are agreements that are made with local authorities on an appropriate community contribution to be made by a developer as part of the planning consent process. In addition the airport has proposed £5,000 per unit for at least 750 affordable homes to be built in recognition of housing lost as a result of expansion. It should be for local and national government and the airport in consultation to determine the appropriate contribution the airport should make to support local development.
- 14.70** It will also be important to ensure that development is brought forward in a way that is sensitive to local needs and reflects the ongoing development of local and regional planning policies. The Commission believes that this can be achieved, whilst recognising concerns expressed in consultation responses that further housing development alongside existing plans would be challenging.
- 14.71** The analysis published as part of the consultation on the shortlisted options contained estimates for how demand for housing in the local authority areas around each airport might increase as result of growth in the number of jobs supported directly and indirectly by airport expansion. These estimates were wide-ranging as they took account of a number of potential growth scenarios. Responses to consultation focused in particular on the difficulty of planning for such a wide range or accommodating the upper end of the range. Taking these concerns into account

the Commission has undertaken further analysis focussing on the *assessment of need* aviation demand scenario. This suggests that for the LHR NWR scheme the theoretical maximum additional demand for housing in 2030 would be around 48,000 units but that in reality additional demand would be much smaller due to the potential for new jobs to be taken up by people already living in the area. This is set out in detail in **Chapter 7**.

14.72 The analysis does not suggest that this number of houses would need to be built to enable airport expansion, but demonstrates that even at its theoretical maximum the additional housing to meet demand is deliverable. Housing would be delivered over several years as the airport builds up its new capacity and afterwards. Demand may be spread across a large number of local authorities and would be only a percentage of the overall demand for new housing in the region.

Integrated decision-making

14.73 Developing new housing as well as the wider associated infrastructure such as health and educational facilities requires local authorities to work together. Statutory planning guidance recognises that there are regional and sub-regional considerations to the delivery of new housing and encourages local authorities to collaborate across administrative boundaries in developing their housing strategies.

14.74 The impacts of expansion at Heathrow would spread across a wide area, creating economic opportunity as well as the responsibility to manage development in a sustainable way across a number of local authority areas both within London and outside. The Commission was pleased to see that some responses to its consultation indicated an appetite across local authorities to work together to identify priorities and the Commission encourages this to continue. Greater localisation of business rates and pooling of budgets across boundaries would facilitate a more coordinated response.

14.75 The approach to coordinating between the relevant branches of local and national government, the airport operator and other organisations is considered in more detail in **Chapter 16**.

Local transport

14.76 A number of responses to the consultation raised concerns about the potential pressures an expanded airport could place upon local transport infrastructure, with concerns over congestion on local roads, airport parking overflowing into residential streets and impacts on local bus services highlighted.

- 14.77** There should be a major shift in mode share for those accessing the airport in the event of expansion with more passengers and employees choosing public transport modes over cars. The percentage of people accessing the airport via public transport would increase from 41% to 53%. This could rise further if a congestion or access charge for motor vehicles was introduced as discussed below.
- 14.78** This mode shift would be supported by new rail investments such as Southern Rail Access to Heathrow, the case for which will be enhanced by airport expansion. New rail and road links could also help to improve local and regional transport for residents who are not using the airport. The Southern and Western Rail Access schemes would improve rail access to and from the airport for people in Richmond and Reading as well those further afield in places such as Bristol and south Wales.
- 14.79** Airport-led initiatives to support employees to use more sustainable transport should also be pursued. The provision of appropriate onsite parking should be set as a condition during the planning process but Heathrow Airport Ltd should be expected to work with local authorities to address any offsite parking challenges that arise.
- 14.80** In addition a congestion or access charge for motor vehicles using the Heathrow site or in the wider area could play an important part. The Commission recommends the introduction of such a scheme should be considered to help ensure that road traffic to and from the airport does not cause unacceptable impacts on local air quality or road congestion.
- 14.81** As part of agreeing an air quality strategy, there must be an agreement on the airport's performance targets on sustainable transport usage and Heathrow Airport Ltd must be held to these targets. This is discussed in more detail at paragraphs 14.110-14.114 below.

Listening to local people

- **A new Community Engagement Board with real influence over spending on compensation and community support and over the airport's operations should be set up under an independent chair, drawing on the models successfully in operation at Schiphol and Frankfurt Airports.**
- **An independent aviation noise authority should be established with a statutory right to be consulted on flight paths and other operating procedures. The authority should act as an impartial source of expert advice, enabling all sides to engage more meaningfully on this complex and subjective issue.**

14.82 Whilst Heathrow Airport Ltd has publically consulted on many aspects of its proposals, the Commission believes that a more permanent, equal and collaborative relationship should be built between the airport and local communities as part of taking forward a new runway. The Commission recommends two structural reforms as the basis for such a relationship.

A Community Engagement Board

14.83 While Heathrow Airport Ltd has improved its community engagement and consultation in recent years, including recently establishing its own Community Noise Forum, consultation responses have reinforced the message that there is a lack of trust between local communities and the airport which must be addressed.

14.84 The principle of extensive community engagement around large airports is well established. At a number of airports around the world dedicated forums have been established to create a platform for the views and expectations of local communities to be heard, both during the delivery of significant new infrastructure and to better balance national and local priorities in the longer term.

14.85 These forums differ from place to place. They are bespoke, with differing remits and objectives, and are adapted to their local circumstances. Nonetheless, all are characterised by strong, independent chairs or boards of directors, and increase the influence of local communities over the operation and impacts of the airport. The Commission has been particularly struck by the approach taken at both Amsterdam's Schiphol Airport and Frankfurt Airport. In both cases a strong commitment to community engagement and influence has become embedded in

the airport process and provides an indication of the scale of ambition required if expansion is taken forward.

Case Study – Amsterdam: The Alderstafel was established at Schiphol in 2006, three years after the construction of the airport’s latest runway. It is the adviser to the Dutch Government on striking the right balance between future development at the airport and maintaining the quality of the local environment. Although it is not required to do so, the Dutch Government is normally expected to accept and implement the groups’ recommendations and to date this has been the case.

The Alderstafel is chaired by Hans Alders, a former Environment Minister in the Dutch Government and Commissioner for the Province of Groningen, who has developed a strong reputation for independence. The impartiality of the chair is noted by community leaders as an important contributor to the success of the group.

Membership of the Alderstafel is inclusive and comprehensive. Representatives from local government and groups from each of the affected communities sit alongside the airport operator, AirFrance-KLM and Dutch air traffic control. The Alderstafel has successfully followed the Dutch “Polder” tradition of continuous dialogue until agreement on an issue can be achieved and has notably reached agreement on the maximum number of ATMs at the airport to 2020 (510,000) as well as on assigning funds to deliver improvements to the quality of life in local communities, including €5 million to redevelop Uilenstede Park in Amstelveen.

To reinforce its policy advisory role the Alderstafel also ensures that local communities are aware of developments at the airport through information dissemination and consultation.

14.86 The establishment of a Community Engagement Board (CEB) at Heathrow would ensure that the views of all stakeholders, but especially those living around the airport, are carefully considered as a new runway is taken forward. The case studies presented in this report at Schiphol and at Frankfurt illustrate both the importance of such a body and the potential scale and scope of its role.

14.87 The CEB should not be a replacement for existing engagement structures, but should seek to complement them. Airport Consultative Committees play an important role at over 50 airports around the UK and it is not necessary to change this to accommodate a new body at Heathrow. The existing Heathrow consultative committee should continue but it will be supplemented by the more extensive terms

of reference of the CEB and the CEB may wish to draw upon its experienced membership.

Case Study – Frankfurt: The construction of Frankfurt’s third runway in the late 1970s and early 1980s was accompanied by some of the largest environmental protests seen in Europe. The new runway was built, but there was a determination to avoid similar levels of protest when a need for a fourth runway was identified in 1997. Engagement was embedded in the process from the start and was undertaken in three stages.

Mediation and consultation took place between 1998 and 2000. Representatives of the Federal Government, Hesse State Government and its towns and cities, the airport, airlines, and NGOs held 24 meetings and 15 hearings, and set up working groups on ATMs, economy, health and ecology which undertook 15 studies. This process led to agreement around the expansion of the airport, the best use of existing infrastructure, measures for noise mitigation, a night flight ban and the continuation of dialogue during the next phase.

During the planning process (2000-2008) the Regionales Dialogforum (RDF) comprised 33 members from towns and cities, NGOs, business, the airport, airlines, air traffic control and trades unions. The RDF held 57 meetings and created sub-groups looking at noise, optimisation of the airport, ecology and health which held a further 149 meetings and completed 19 studies. Another 20 public hearings were undertaken and a citizens advice office was developed as a liaison agency and information centre.

In December 2007 the Hessian Ministry of Transport granted planning permission for the fourth runway and at the same time the Forum Flughafen und Region (FFR – Airport and Region Forum) was created to lead engagement during the construction and operational phases.

The FFR has a board of directors with an independent representative sitting alongside a representative from the towns and cities and from the aviation industry. A Steering Committee (the decision-making body) comprises representatives of Hessian State Chancellery, Hessian Ministry of Transport, Expert Group and the Aircraft Noise Commission. The Steering Committee does not include representatives of community groups. However, the FFR has an Expert Group on Active Noise Abatement and a larger Regional Discussion Group which engage a wider range of stakeholders, and which report to the Steering Committee.

- 14.88** Membership of a CEB could be made up in a number of ways. International examples include representatives from the airport, air traffic control, airlines and where applicable a noise expert (e.g. Aircraft Noise Commission at Frankfurt). Local and regional government representatives will typically have an interest in the wider economic and social impacts of the airport whilst local community representation is largely determined by those impacted by aircraft noise. The Commission is inclined towards the inclusive membership model of the Alderstafel which has been cited by UK community groups as preferable to the model adopted at Frankfurt. Nonetheless it is most important that the structure of a CEB is one that facilitates decision taking and delivery. A strong, independent chair will be important in this respect.
- 14.89** A CEB will require administrative funding. The case study at Frankfurt Airport illustrates the volume of work that will be required during the planning and construction phases of the airport development and it will be important that the group is able to undertake appropriate engagement and research. Any administrative funding will need to be reliable and should not undermine the independence of either the group or the chair. It may be appropriate for this money to come from Government to underscore the group's independence from the airport operator, but Heathrow Airport Ltd might also be expected to make a contribution.
- 14.90** Both the Alderstafel and the FFR are constituted to spend money on mitigation and quality of life projects in the communities around the airport. Similarly, the CEB should have real influence over spending on compensation, noise insulation and community support. It should work effectively in concert with local authorities and an independent aviation noise authority where appropriate.
- 14.91** Many respondents to the consultation expressed doubts that Heathrow Airport Ltd would deliver on its compensation and mitigation commitments. Providing the CEB with oversight and enforcement of the package and the power to arbitrate where there is disagreement could give comfort to local communities and increase local trust in the airport and the fairness with which the new runway will be delivered.

- 14.92** The CEB is also likely to have an important role in information provision and community support. Access to reliable information from a trusted source will be increasingly important. On sensitive or controversial issues, information provided by the airport operator is often treated with suspicion by local people and even that published by the independent regulator (the CAA) is not always taken at face value. Delivering a new runway will require the provision of a large amount of detailed information that local communities may struggle to manage. They may find it difficult to understand their entitlements to compensation and mitigation, to navigate through the planning process and to contribute more widely. They may also want easily comprehensible information on the potential effects of changes to aviation noise or other factors. Furthermore the CPO process and the voluntary purchase schemes will be stressful.
- 14.93** A CEB should be a trusted repository of information, with a remit to develop awareness throughout the community and provide advice and support to those who need to move house. Both the Alderstafel and FFR have an information provision role, a role that at Frankfurt has been extended to providing a physical drop-in centre in addition to online resources.

Independent aviation noise authority

- 14.94** In its *Interim Report*, the Commission recommended the establishment of an independent body, with a duty to provide statutory advice to the Government and the Civil Aviation Authority on issues related to aircraft noise. It recommended the Government and the CAA publish their reasoning in any cases where the decisions diverged from the advice provided by the body, and set out a series of specific functions which the body might carry out (see box below).

An independent aviation noise authority could:

- Provide statutory advice to the Secretary of State for Transport regarding proposed changes to Noise Preferential Routes.
- Provide statutory advice to the Secretary of State for Transport and the CAA in respect of the proper structure for noise compensation schemes.
- Provide statutory input to planning inquiries relating to airport infrastructure in respect of the appropriate controls that should apply in respect of aircraft noise.
- Work with the developers and operators of any new airport capacity as well as communities affected by the development to define a noise envelope to create a balance between aviation growth and noise control.
- Conduct research into the best means of monitoring and reporting aircraft noise, as well as its association with annoyance and impacts upon human health and their possible mitigation.
- Publish comparative assessments of airlines' performance in reducing their noise impacts.
- Act as a statutory consultee in planning applications with respect to airport infrastructure or housing developments which would have an effect upon the population affected by airport noise.
- Mediate by request between airports and their local communities in disputes relating to noise monitoring, the functioning of airports' advisory committees, and airports' compliance with their noise action plans and, where appropriate, advise the CAA in respect of potential breaches of noise regulations.

14.95 Responses to the Commission's consultation underline that there is still a need for such a body, in particular to help address the considerable lack of trust that remains between communities close to the UK's airports and the airports themselves.

14.96 The CAA carries out a number of functions targeted at ensuring aircraft noise is taken into account, not only within the airspace change process, but also within planning applications, and aims to improve the transparency associated with monitoring and reporting aircraft noise. However, as the *Interim Report* highlighted, there are still real issues to resolve around the manner in which communities are engaged in processes which impact aircraft noise (most notably the airspace change process), and in holding those involved in these processes to proper account.

14.97 The *Interim Report* also brought out the risks associated with requiring final decisions on airspace changes of a certain scale to be taken by the Secretary of State for Transport, as is currently the case. Such decisions become open to being politicised, risking delay or, at the extreme, failure.

14.98 The Commission therefore reaffirms its recommendation that an independent aviation noise authority should be established. The noise authority should be given statutory consultee status and a formal role in monitoring and quality assuring all processes and functions which have an impact on aircraft noise, and in advising central and local Government and the CAA on such issues.

Figure 14.1: How a noise authority would interact with other bodies

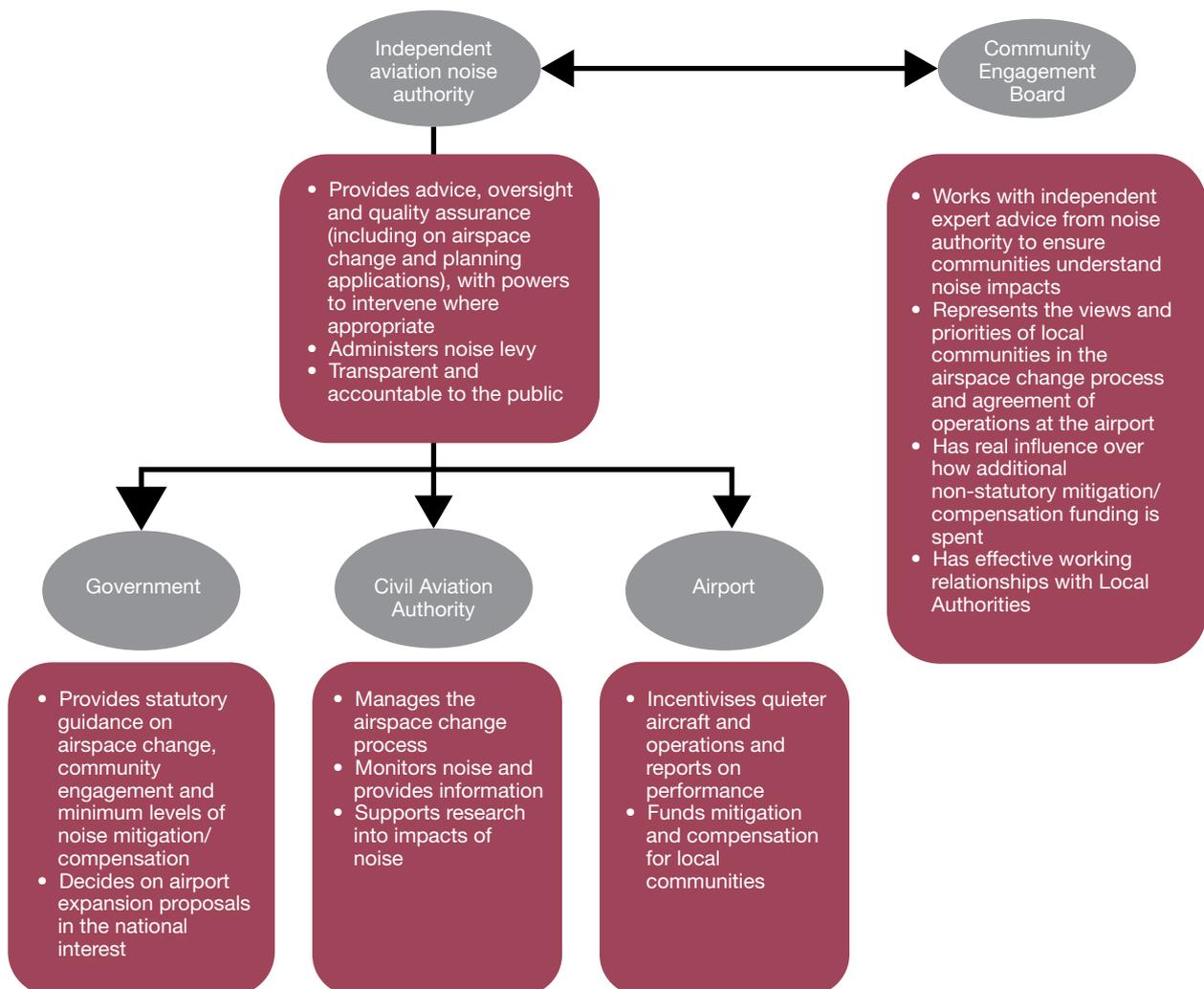

14.99 To help it carry out its duties, the authority should be given powers which allow it access to the relevant operations of the CAA, airports and others in the aviation industry, ensuring that it can monitor those operations and report to the public on whether they have been carried out in accordance with the relevant statutory processes or guidance, and in a fair and transparent manner.

- 14.100** Where it finds organisations have breached due process, it should have powers to intervene and should be able to require organisations to review and amend relevant guidelines or, in extreme cases, to fine organisations. The noise authority must be a trusted presence, which members of the public can turn to for advice on the functions of airports, the CAA and the Government, with respect to their processes and duties that have an impact on aviation noise.
- 14.101** It should play a key role in administering a noise levy, advising on the exact design and weighting of a charge, and provide guidance on how funds raised could be most fairly allocated with regard to local noise impacts. This may include an assessment of pre-existing arrangements at different airports. At Heathrow the CEB should also play an important role, with real influence over how funding is spent.
- 14.102** The authority should have a national remit and, as set out in the *Interim Report*, the Commission believes that it is appropriate irrespective of any Government decision on new runway capacity.
- 14.103** The noise authority must be truly independent, with a lead commissioner or panel drawn from outside the aviation industry, and not dependent on the airports or the aviation sector for funding for its administrative and operating costs. It may be appropriate for these costs to be met from the noise levy. The authority should operate in a transparent manner, publishing the details of its operations, and be accountable to the public through Parliament.
- 14.104** To establish such a body would require legislation. In particular, the Government will need to support the functioning of the noise authority by putting in place statutory guidance that details the duties of each organisation involved in the airspace change process and how they must carry out those duties, including how they should engage with communities. This guidance must be supported by a clear strategic case to support the airspace change process, with particular regard to why airspace modernisation is needed.
- 14.105** Establishing an independent aviation noise authority should not delay delivery of a new runway at Heathrow. For example, with respect to providing advice on planning applications, the level of independent scrutiny and public consultation to which the Commission itself has subjected shortlisted schemes means that it would not be necessary for the authority to consider any scheme again as part of the planning process, but it would play an important role in agreeing and monitoring operations at the expanded airport.

Providing Legal Reassurance

- **Heathrow Airport Ltd should be legally bound to deliver on the promises that it makes to local communities. There should be clear independent monitoring of performance against commitments and appropriate means of redress.**
- **Additional operations at an expanded Heathrow Airport must be contingent on acceptable performance on air quality. New capacity should only be released when it is clear that air quality at sites around the airport will not delay compliance with EU limits.**
- **The Government should make a firm commitment in Parliament to rule out any fourth runway at Heathrow. This may be as part of a National Policy Statement or through legislation.**

Building trust

14.106 Lack of trust between airports and their local communities has been a strong theme of responses to the Commission's consultation. Local people are concerned that the assessments made of noise and other environmental impacts may not hold true or that promises made on compensation and mitigation may not be honoured. Private and foreign ownership of airports as well as historic commitments that have not been honoured are often cited as reasons for the mistrust.

14.107 Institutional reform will be necessary to enable a better functioning relationship between airport and community. But in addition there should be a firm legal foundation to any commitments made to local communities. The promises that the airport makes should be legally binding including in the event of it coming under new ownership. There should be clear means of redress and transparent monitoring of performance against commitments.

14.108 There are a number of legal options to enshrine such commitments:

- Manchester Airport's planning application for its second runway was underpinned by 120 'community guarantees', incorporated into a Section 106 planning agreement between the airport and the local council. This provided legally binding commitments that future growth would take place within environmental limits and that the airport would seek to avoid, mitigate or compensate for environmental damage. Environmental actions, targets and limits were developed in consultation with local community representatives and

statutory bodies. The value of these guarantees was reinforced through transparent monitoring, external oversight and third party auditing and reporting of performance, which has provided further reassurance to local residents.

- In 1979 a private contract between Gatwick Airport and West Sussex County Council (the relevant planning authority at the time) committed the airport not to develop any additional runway for 40 years.
- A National Policy Statement may be used to determine the national need for a particular type of infrastructure as well as to identify suitable or unsuitable sites and to specify conditions that must be met in taking forward any development.
- An Act of Parliament is the strongest guarantee that can be given. Whilst Parliament is sovereign and cannot bind its successors, legal commitments made in Parliament would have greater force than any other option.

14.109 The Government will need to consider all the recommendations in this *Final Report* and will be responsible for making a decision on airport expansion. It should ensure that as part of that process the wider package of commitments to local communities is placed on a transparent, clear and unambiguous legal footing.

Air quality

14.110 Concerns about air quality and its health impacts are serious and important for local people and they will want reassurance of concerted action. Tackling air quality is not, however, only the responsibility of the airport operator. Heathrow is situated close to the M25, M4 and other major roads and the majority of emissions in the area are caused by road traffic unrelated to the airport. It will therefore be necessary for the Government and Heathrow Airport Ltd to agree an approach that ensures effective and concerted action on all sides.

14.111 Investment in surface transport including new rail links, support for low emission and electric vehicles, congestion or access charge schemes (as recommended by the Commission), and transport demand management can all play a part in ensuring that airport expansion does not result in unacceptable air quality impacts. Changes to airport operations both on the ground (such as reducing taxi times for aircraft or use of low emission ground vehicles) and in the air (such as use of steeper approaches) will also be important.

- 14.112** The Commission's assessment is that the air quality issue around Heathrow is a manageable part of a wider problem, the underlying causes of which will need to be addressed by the Government. The recent Supreme Court ruling requiring the UK Government to submit an action plan to the European Commission detailing how it will comply with limit values for nitrogen dioxide creates a supervised process for national and regional measures required to resolve the background air quality issue.
- 14.113** Nonetheless, the Commission recommends that new runway capacity at Heathrow Airport should only be released when it is clear that air quality at sites around the airport will not delay compliance with EU limits. This should be a legally binding planning condition. In this way the airport will have a strong incentive to deliver on its air quality commitments and local people should have greater reassurance of this.
- 14.114** Given the range of factors involved it may not be credible for the airport to be held liable for elements outside its control. This should not soften the Commission's recommendation on compliance with EU limits, but suggests that an appropriate form of risk-sharing and financial liability between Government and the airport operator may be required.

Future development

- 14.115** In addition, a particular concern for residents near to Heathrow is that a third runway in the early 2020s could lead to a fourth runway in the future. The Commission sees no sound case for such a development.
- 14.116** In airspace terms it would be increasingly difficult to manage additional flights at the same location. Advice from NATS is that, whilst the number of movements that can be achieved by an airport increases with the number of runways, it is not a simple pro-rata relationship, with the need to provide sufficient capacity and airspace to ensure safe operations at all times ensuring diminishing returns. Specifically NATS advises that a maximum of 800,000 ATMs per annum could be supported by an airport that operated four independent parallel runways within the congested airspace of London and the South East.
- 14.117** In addition, the physical geography challenge of fitting a fourth runway in at Heathrow would be increasingly great. The Commission considered the extent to which the shortlisted schemes might be able to accommodate further significant expansion, but it was not possible to identify any option for a fourth runway at the Heathrow site that could be delivered without incurring both reduced benefits and substantially increased financial and environmental costs.

14.118 Moreover, while there is a potential demand case for a second additional runway in the South East by 2050, it does not follow that there would necessarily be an economic or environmental case for such a development.

14.119 Nonetheless, given the history of development at Heathrow, the Commission recognises that the local communities may be mistrustful of such statements, particularly if coming from the airport itself. That is why the Commission recommends that the Government make a firm ruling in Parliament on the matter. A statement that there should be no fourth runway at Heathrow made as part of a National Policy Statement or through legislation would be the best way to give lasting reassurance to communities.

15. Supporting Growth and Connectivity Across the UK

- **Expansion is likely to protect and bolster domestic services in and out of London leading to a rise in the number of passengers and frequency of services on the thickest routes.**
- **The Government should alter its guidance to allow the introduction of Public Service Obligations on an airport-to-airport basis and should use them to support a widespread network of domestic routes at the expanded airport.**
- **Heathrow Airport Ltd (HAL) should implement additional measures to enhance domestic connectivity, including introducing reduced charges and start-up funding for regional services.**

Impacts of Heathrow expansion on domestic connectivity

- 15.1** Capacity constraints at Heathrow Airport have seen the number of domestic connections decline at the airport over recent years. No daily service has operated between Heathrow and Liverpool since 1991, Inverness since 1997 and Durham Tees Valley since 2008. On many of the remaining domestic routes the frequency of service has reduced; over the past 20 years the number of daily services operating to and from Glasgow and Edinburgh has fallen by over a third.
- 15.2** This reduction in connections to London and – through the connections afforded by Heathrow – its broad international route network has been of grave concern to the UK's nations and regions. In responses to consultation (and to the Commission's *Discussion Paper 6: Utilisation of the UK's Existing Airport Capacity*, which was published in June 2014), a large number of councils, elected representatives, business groups and Local Enterprise Partnerships from across the UK stressed the importance and desirability of retaining, renewing or establishing links to Heathrow. Often these parties cited the serious influence that the loss or gain of a connection to Heathrow can have on a nation or region's economy.

15.3 Expansion will provide a valuable opportunity to reverse the long-standing trend of declining domestic links into the nation’s hub airport, providing new slots for airlines to operate services to and from areas of currently unserved demand. Expansion will also protect and bolster existing domestic services into London, leading to a rise in the numbers of passengers on, and the frequency of, the thickest routes. This remains the case to 2050, the furthest point to which demand is forecast, as shown in **Figure 15.1**.

Figure 15.1: Domestic passenger numbers at Heathrow Airport in the do minimum and Heathrow Airport Northwest Runway option without further measures to support or stimulate domestic connectivity (includes domestic interliners)

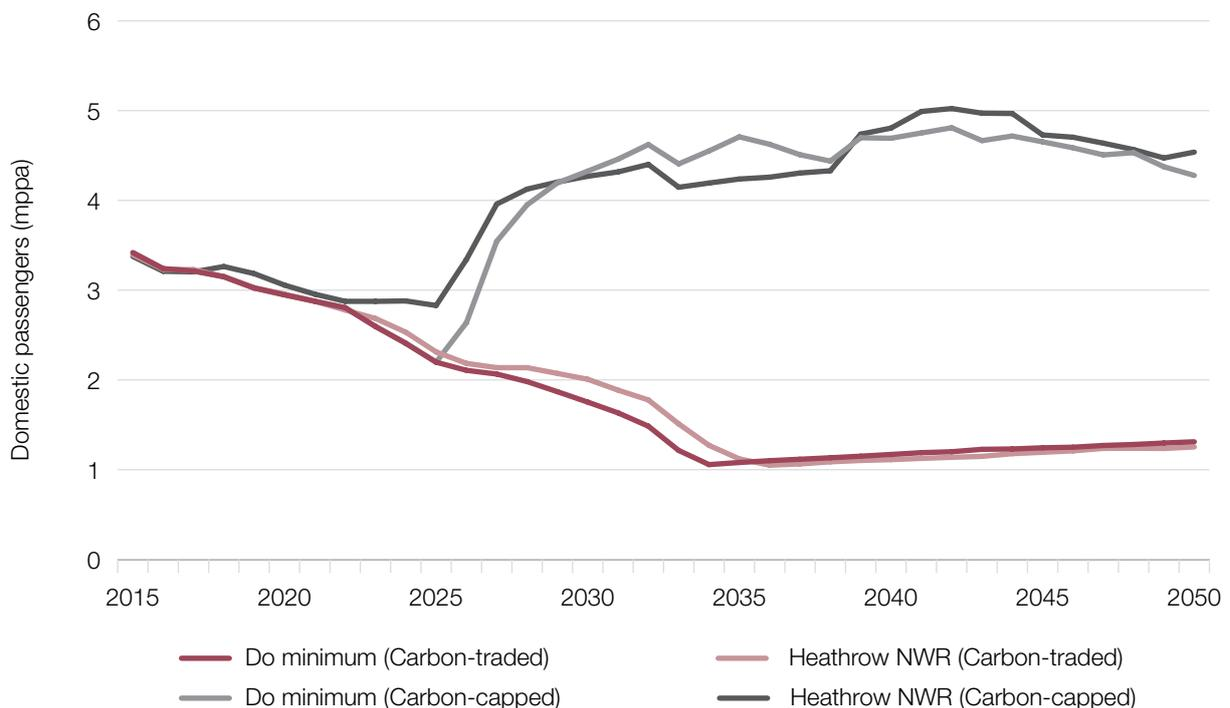

Source: Airports Commission analysis

15.4 The new slots made available at Heathrow would allow airlines to establish new domestic links to the capital, re-establish lost connections and increase frequencies on those that are already in place. Heathrow Airport Ltd and easyJet’s consultation responses argued that were the low-cost carrier to move to the airport, it would seek to develop new services to Inverness, Jersey, Belfast International and the Isle of Man. And a number of regional airports’ consultation responses stressed the strength of demand for services into London and the South East from their areas. To support this point, the National Connectivity Task Force put forward analysis considering the latent demand for services from the UK regions to the capital, suggesting that in 2040 domestic services could utilise 136-175 additional daily slot pairs at an expanded Heathrow, compared to current day slot allocation of 55 daily

slot pairs. This would equate to 6.5% of runway capacity at the expanded airport being utilised for domestic services, up from 4.2% currently.

- 15.5** Moreover, these developments should be considered in the context of the advent of HS2, as well as improved rail speeds and frequencies on the Great Western and Midland Main Lines. As with the provision of new slots for domestic flights, these improvements will substantially enhance the UK's internal connectivity, strengthening the transport links between London and the country's major cities. They will also widen the catchment area of Heathrow itself, bringing the nation's hub airport and the strong international connectivity that it provides within a two hour journey time of 20 million people, and a three hour journey time of 38 million people, via surface transport.
- 15.6** As a result, expansion will generate significant economic benefits across the UK's nations and regions. Improved links to London and the South East, combined with the lower cost of transport and increases in the level of international trade, will boost productivity in regional economies. Using the carbon-traded forecast the Commission's macroeconomic assessment suggests that 60% of the economic impact of expansion may be felt outside London and the South East as businesses all over the country feel the benefits of increased connectivity and openness. When an assessment is undertaken with carbon emissions constrained to the CCC planning assumption the economic benefits are less strong, but they continue to be well distributed across the country, in similar proportion to the carbon-traded assessment.
- 15.7** Against this positive outlook, it is important to note that even in the event of expansion, a number of competing pressures may limit the increase in domestic services to an enlarged Heathrow. One such pressure could be continuing competition from overseas hubs, which may still be able to offer cheaper services, higher frequencies, or more convenient connections on some routes. An expanded Heathrow is also likely to see rapid growth in demand, which may relatively quickly begin to exert pressure on slots during the most popular periods.
- 15.8** The Commission's forecasts reflect these pressures and suggest that without specific measures to support domestic connectivity even an expanded Heathrow may accommodate fewer domestic routes in future than the seven served currently. It would still however see more than the three domestic routes predicted to be available from the airport without expansion.

- 15.9** Given the historic long-term pressures on the availability of capacity for domestic services at a constrained Heathrow, any stabilisation in the numbers of domestic services operating to the airport is to be welcomed. Nonetheless, the Commission believes that this should not be the limit of the UK's or the airport operator's ambition.
- 15.10** In summary, a new runway at Heathrow will enhance the domestic connectivity of the UK, strongly benefitting the nations and regions outside London and the South East. In order to ensure that these benefits are widely spread and a diverse network of domestic routes is supported at the expanded airport, however, additional measures may be required. These are discussed in the next section of this chapter.

How to ensure that the benefits of expansion propagate throughout the UK

- 15.11** A number of respondents to the consultation – particularly regional bodies such as local councils, local enterprise partnerships and regional airports, as well as Flybe (the airline which serves the greatest number of the UK's regional airports) – called for the Commission to recommend steps to enhance the positive regional connectivity impacts that would accrue from a new runway in the London airport system. In particular, these bodies urged the Commission to identify measures to ensure that even greater numbers of services operate on a broader range of routes between London and the regions than are forecast.
- 15.12** A common suggestion was that slots at an expanded Heathrow or Gatwick could be reserved for domestic flights to and from particular regions, for example through conditions set out at the point of granting planning permission for the new infrastructure. The Commission considers that there is no viable legal basis upon which this could be achieved. Slot allocation in the UK is governed by the EU Slot Regulation. Once a slot is allocated at a co-ordinated airport its use thereafter is governed by the Regulation, which generally permits the slot holder to transfer its use from one route or type of service to another. There is no exemption from this rule and any restrictions or protections would place the UK in contravention of the EU Slot Regulation and liable to infraction proceedings by the European Commission. Any measures to ring-fence or exempt slots stipulated in planning permissions would be overridden by the requirement to adhere to the Regulation.

- 15.13** The Commission also considered a range of alternative proposals put to it in consultation for protecting or enhancing domestic connectivity, none of which was found to represent a viable solution.¹⁰³ These included:
- renegotiation of the EU slot regime;
 - tailoring aspects of the airport's new infrastructure to smaller aircraft, which are more suited to short-haul routes;
 - actions by airport coordination committees in relation to slot allocation; and
 - amendments to the remit of the CAA.
- 15.14** Some respondents also argued that greater use of RAF Northolt, coupled with improved surface access links between RAF Northolt and Heathrow, could facilitate domestic connectivity. The Commission has not taken a position regarding the future use of civilian capacity at RAF Northolt. It has not, however, been convinced that there is a credible solution for providing a transfer service between RAF Northolt and Heathrow or that RAF Northolt is a viable long-term option to address Heathrow's capacity constraints.
- 15.15** The only viable way of ring-fencing slots for certain services is via the use of Public Service Obligations (PSOs), which allow the state to provide subsidies to a carrier on a route which is not commercially viable. EU Member States are entitled to establish PSOs in respect of air services between two airports in the European Community, where one of these airports serves a peripheral or development region, and where the air service is considered 'vital for the economic and social development of the region which the airport serves'. As PSOs constitute State aid interventions, their use is carefully monitored by the European Commission, in order to protect against distortions of competition in the Single Market.
- 15.16** The UK has in the last 12 months established two PSOs, one from Newquay Airport to London Gatwick and the other from Dundee Airport to London Stansted. Both routes were subsidised out of the Government's Regional Air Connectivity Fund (RACF), a £20 million fund set aside by the coalition Government to safeguard routes to and from the London airport system and the UK regions.
- 15.17** Given the pressures on regional services to Heathrow and Gatwick witnessed in recent years, and the forecast continuation and intensification of these pressures in the coming decade, the establishment of PSOs (where the relevant criteria for imposition are met), supported with funds from the RACF, is a proportionate and

103 See *Consideration of Consultation Responses*.

effective measure for protecting regional air services that has safeguarded valuable connectivity to the regions in question.

- 15.18** The Commission believes, however, that the Government should interpret the PSO regime, and deploy PSOs, more widely than at present. Currently the Government's guidance on the application of PSOs defines a 'vulnerable route' very tightly, only considering an air service to the capital to be vulnerable if it is the last remaining route from a region into any of London's six airports.
- 15.19** This interpretation, however, is a matter of policy and does not have any legal basis. Under EU Regulation 1008/2008 it is clear that PSOs can be established, where the route is considered vital for the economic and social development of a region, between a peripheral or development region and a specific airport in an airport system; this would include a specific London airport. Some respondents to the consultation highlighted that other EU Member States interpreted the PSO provision on an airport-to-airport basis, in line with this reading.
- 15.20** The particular types of connectivity that can be accessed at an expanded Heathrow (particularly, for example, its dense long-haul route network) are, and will continue to be, important for the economic and social development of the UK nations and regions, and this should be seen as an important factor when considering the establishment of PSOs. For this reason, the Commission recommends that the Government should alter its guidance to allow the introduction of PSOs on an airport-to-airport basis and should use them to support a widespread network of domestic routes at the expanded airport.
- 15.21** Moreover, this change in the Government's guidance does not need to be delayed until expansion takes place, as airport-to-airport PSOs could be used in the interim to safeguard existing routes operating into the capital, or to support the establishment of routes to other UK airports, including airports outside the London system.
- 15.22** Reinterpreting its stance on PSOs will make the Government better able to protect services between the UK's peripheral and development regions and its most well-connected airports. This could benefit domestic connectivity in the coming decade – during which the number of domestic services to Heathrow and Gatwick are forecast to decline further – and, crucially, in the period after the new capacity at Heathrow comes on-stream.

- 15.23** Given the current pressures on capacity at Heathrow, however, it would not be possible to support the establishment of new routes through PSOs unless and until expansion takes place, and if additional capacity is not provided it is likely that further reductions in domestic services will be seen.
- 15.24** All PSOs would continue to be assessed by the UK Government and the European Commission in relation to the adequacy of existing transport links to the region and the scale of the economic benefit that could derive from protecting the threatened air services, and would require assessment by the UK Government and the European Commission.
- 15.25** In addition to changes to the PSO regulations, it is important to consider what roles airlines and airport operators can play in supporting regional connectivity, both now and in the future. For instance, if the same level of aeronautical charge is applied per passenger, no matter if that passenger is travelling domestically or internationally, this can often be a deterrent to regional services. If lower aeronautical charges were applied for domestic routes or passengers, these services would be encouraged.
- 15.26** To this end the Commission welcomes the recent commitments by Heathrow Airport Ltd to establish measures to facilitate connections between the airport and the UK regions. These measures include a £10 per passenger discount to domestic routes (currently out to consultation, but expected to start in January 2016), and £10 million of start-up funding to support the establishment of new routes into the expanded airport. These are welcome measures which could markedly improve UK regional connections to the hub airport, and the Commission recommends that they should be taken forward expeditiously by Heathrow Airport Ltd.
- 15.27** Expansion at Heathrow would enhance connections between the UK regions and London and its associated onward connectivity, reversing the trend of declining links between London and the rest of the UK witnessed in recent decades. The Government – working in conjunction with airlines and Heathrow Airport Ltd – should grasp the opportunity that expansion provides, using PSOs to support a widespread network of connections to the UK's nations and regions and thereby to protect their access to the global connectivity crucial to future prosperity.

16. Next Steps

Introduction

16.1 This chapter sets out how central and local Government and other bodies such as the regulator (the CAA), and the airport operator should be engaged in efficient and timely delivery of new capacity. Delivery of new runway capacity will necessarily take several years to complete. In the meantime the need to make best use of existing infrastructure will remain.

Delivering new capacity

16.2 Securing planning permission for, constructing and opening the new runway will involve a number of phases, and a number of organisations, as illustrated at **Figure 16.1**.

Figure 16.1: High level delivery road map

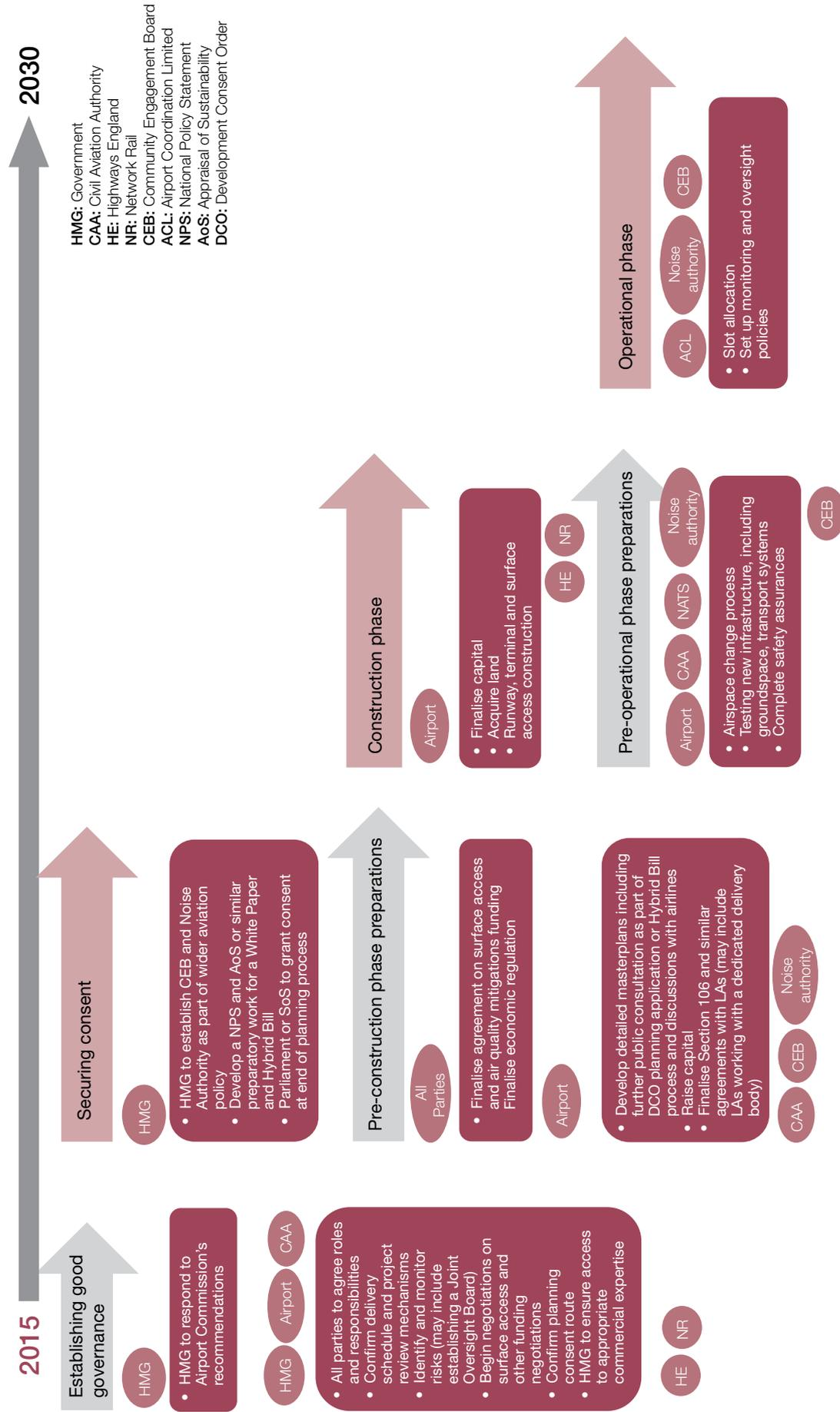

Establishing relationships

- 16.3** The primary responsibility for delivering the new runway is expected to lie with the private sector scheme promoter, Heathrow Airport Ltd. It is credible to assume that the new runway would be privately funded, delivered and operated.
- 16.4** Nevertheless, there are a number of processes which will require Government to deliver important enabling actions including:
- granting planning consent for development;
 - driving through key supporting policies such as to deliver airspace changes or to establish an independent aviation noise authority and a Community Engagement Board; and
 - facilitating the delivery of the required surface access works.
- 16.5** A timely decision by Government on the Commission's recommendations will greatly facilitate expeditious delivery of new capacity. Following that decision, it will be critical that all parties involved in delivering the new runway agree clear roles and responsibilities and an appropriate governance framework quickly.
- 16.6** It will be necessary to confirm the schedule for delivering the new runway and surface access requirements and plan for appropriate review, challenge and redress mechanisms to ensure that all parties are incentivised to play their part in getting the new capacity in place as early as possible before 2030. The Government will need to consider delivery options and arrangements to ensure value for money for airport users and taxpayers. Risks to both the private and public sector should be identified and monitored and responsibility for managing different risks clearly allocated and defined. As part of this it is likely to be imperative that Heathrow Airport Ltd and the Government work together at the earliest possible stage to ensure effective and concerted action on the necessary air quality mitigation measures, including incorporating these as part of the Government's air quality plan. As set out in **Chapter 14** an appropriate form of risk sharing between the airport and the Government may be required.
- 16.7** A stable and predictable economic regulatory environment will be important to help ensure the most efficient financing arrangements for the scheme. To this end early engagement between the airport, airlines and the CAA as well as Government will be beneficial. Under current market conditions, supportive measures from the Government such as provision of guarantees are unlikely to be required. However, should conditions change this is something which the Government could consider

as a way of reducing the funding and financing risks and ongoing monitoring of the situation will be appropriate.

- 16.8** It is expected that the scheme promoter will begin to raise capital to fund development costs as well as planning the financing approach for the new capacity. It will also need to begin discussions with the airline community and CAA regarding the detailed design and phasing of the new infrastructure. That will include looking at options to control costs and bring down any aero charge increase required (for example, value engineering, reviewing the scope of the proposed scheme, completing revenue-generating elements of the scheme as quickly as possible and taking steps to increase non aero revenues).
- 16.9** There is considerable evidence of appetite for equity investment in infrastructure assets, particularly from infrastructure funds, institutional investors, sovereign wealth funds and some corporates. Moreover the UK's regulatory model has been heavily supported by domestic and international investors. Nonetheless the amounts of equity to be raised are large and the willingness of parties to invest the required sums should be considered. This may include confirmation that the shareholders' agreement between consortium members should not become an impediment to raising the requisite equity capital.
- 16.10** Commercial negotiations on the funding of different elements, most particularly surface access, will need to begin and the Government will need to ensure it has access to appropriate commercial expertise to support the processes of setting up agreements and managing negotiations.
- 16.11** All elements of the process need to occur in the right sequence and at the right time. All parties will want to maintain momentum throughout the timetable to delivery, and financial incentives may be considered. It may also be appropriate to set up a Joint Oversight Board between the airport operator and the Government to monitor and manage the project schedule and the associated risks.

Coordinating delivery and wider development

- 16.12** Effective institutional mechanisms should be put in place to ensure timely and efficient delivery of a new runway. It is expected that Heathrow Airport Limited (HAL) as the private owner and operator of Heathrow Airport would be the scheme developer, funding and leading delivery of the airport expansion project. Nonetheless, expansion will have impacts far beyond the airport boundary.
- 16.13** In establishing the Airports Commission, the Government has invested in a detailed and thorough evaluation of the complex issues surrounding the need, impact and

delivery of airport expansion in the UK. These include issues ranging from international connectivity, global competition and economic impacts, to aviation noise, local jobs, housing, surface transport, biodiversity and air quality. Awareness of this multi-dimensionality is reflected in the Commission's evaluation of 16 separate appraisal modules for shortlisted schemes.

- 16.14** Responsibility for decisions in these areas today, with regard to Heathrow Airport, fall under different political and institutional arrangements, including the Greater London Authority, several local authorities both within and outside London, the CAA as economic and safety regulator, Highways England and Network Rail, environmental bodies, as well as various parts of central Government. In addition to the airport itself, other private sector organisations would need to play an important role in the construction and operation of the new capacity and any wider related development.
- 16.15** The successful delivery of expansion at Heathrow will require consideration of how the different work-strands interact with each other and with the existing and planned services and infrastructure across the affected geographical area. An approach of this kind will be needed both for elements directly related to the delivery of the new runway and for wider related development, such as any growth in housing and commercial facilities that may follow.
- 16.16** In the early stages, Heathrow Airport Ltd will need to engage with the relevant branches of central, regional, and local government to take forward its scheme. That will include discussions on the scale and timing of its contribution to the cost of wider development or of any essential delivery elements off-site. The Government will need to consider how to coordinate its response to these approaches and take forward a multifaceted relationship with the airport and other stakeholders over several years. The Commission recommends that the Government consider establishing a dedicated body to ensure the efficient delivery of a project of this technical and political complexity.
- 16.17** Any such body would be temporary, with highly-focused terms of reference, and would be tasked with delivering timely and effective development based on informed and integrated planning. It would need to address a wide range of impacts arising from the expansion of the airport (which cut across political and institutional boundaries). It would not attempt to act as a regional entity (and would not be a Regional Planning Authority) but could address airport-related impacts and the specific city sub-regional issues that affect London and neighbouring councils. The Government would need to consider whether it would be necessary to establish such a body on a statutory footing.

- 16.18** Effective working within existing governance structures would be crucial for any such body as it would have responsibilities that touch on and contribute to a large number of services, but would not be the main provider or planning agency for any of those services. Its ability to carry out its duties would flow from its role in directing how and where investment is spent. That would create a strong incentive for other authorities across the area to work closely with it. Statutory powers could strengthen the incentive further.
- 16.19** Airport expansion will take place against a backdrop of a rising population and the need for sustainable economic development and public services that ensure that people can live well. In that respect many of its associated challenges are not new. By looking at the impacts over a wider area than the immediate surrounds of the airport, a dedicated delivery body could address the implications of the new runway and associated development, including the location of any additional housing and employment centres (taking into account surface transport improvements).

Progressing wider policies

- 16.20** The Government may wish to deposit a ‘Paving Bill’ or table a motion in Parliament to set out its early commitment to progressing the Commission’s recommendations and delivering policies that would support regional and community interests in the event of expansion, including a commitment to establish a Community Engagement Board and an independent aviation noise authority and to amend its guidance on PSOs in order to secure valuable regional connectivity.
- 16.21** The frameworks and funding models for taking forward these policies will need to be established through a separate Programme Bill, which could be taken through in parallel to the planning consent process.

Planning and consent

- 16.22** The Commission has considered different possible approaches to planning consent, including publishing a Discussion Paper (*Discussion Paper 07: Delivery of new runway capacity July 2014*) and reviewing comments received. Through this work it has identified two credible alternative routes (Figure 16.2):
- i) Using powers granted by the Planning Act 2008 (as amended by the Localism Act 2011) the Secretary of State for Transport may publish a National Policy Statement (NPS) setting out an assessment of the need for National Strategic Infrastructure Projects (NSIPs) in the aviation sector. There are already NPSs for a number of infrastructure sectors including energy, ports and waste.

Once ratified the NPS will give direction to the Planning Inspectorate¹⁰⁴ which will consider specific applications submitted by any scheme promoter. It is then for the Secretary of State, taking account of the Planning Inspectorate's recommendation, to decide whether to allow that scheme by granting a Development Consent Order (DCO). A NPS is not required for a DCO to be granted, but in practice it is very unlikely that any airport scheme promoter will submit a planning application without a clear statement from Government on the need for additional runway capacity.

- ii) Alternatively, a Hybrid Bill may be introduced in Parliament. This has recently been the route adopted for major transport projects such as HS2 and Crossrail (although they are not privately funded or delivered schemes as the third Heathrow runway would be most likely to be). Under a Hybrid Bill, Parliament is responsible for debating and agreeing the principle of the Bill (the need for such a scheme) as well as agreeing and consenting the detailed design of the scheme. The process includes detailed examination and the opportunity for members of the public to make representations at committee stage.

16.23 Although there are substantial procedural differences between these approaches, the fundamentals of setting a strategy, considering a proposed scheme in detail and thorough analysis and public consultation at each stage are common to each:

Figure 16.2: NPS/DCO planning process

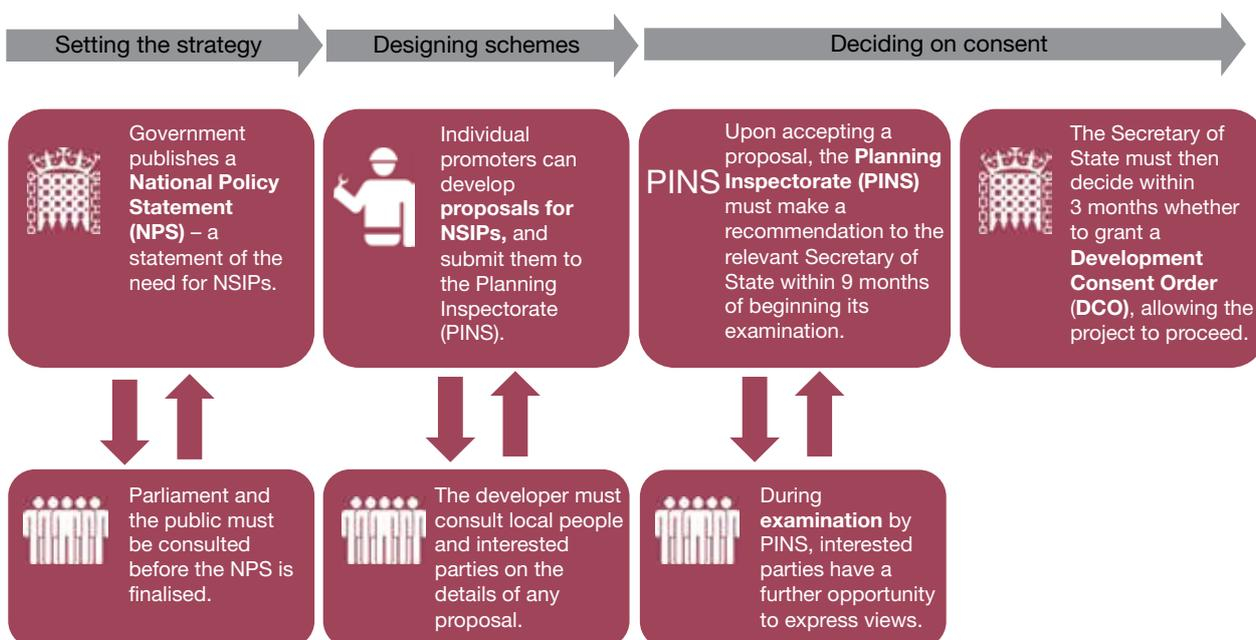

104 The Planning Inspectorate is an executive agency of government employing around 790 staff including examining inspectors for NSIP applications. It is an impartial body responsible for making and advising upon a wide range of decisions on local and national planning matters across England and Wales

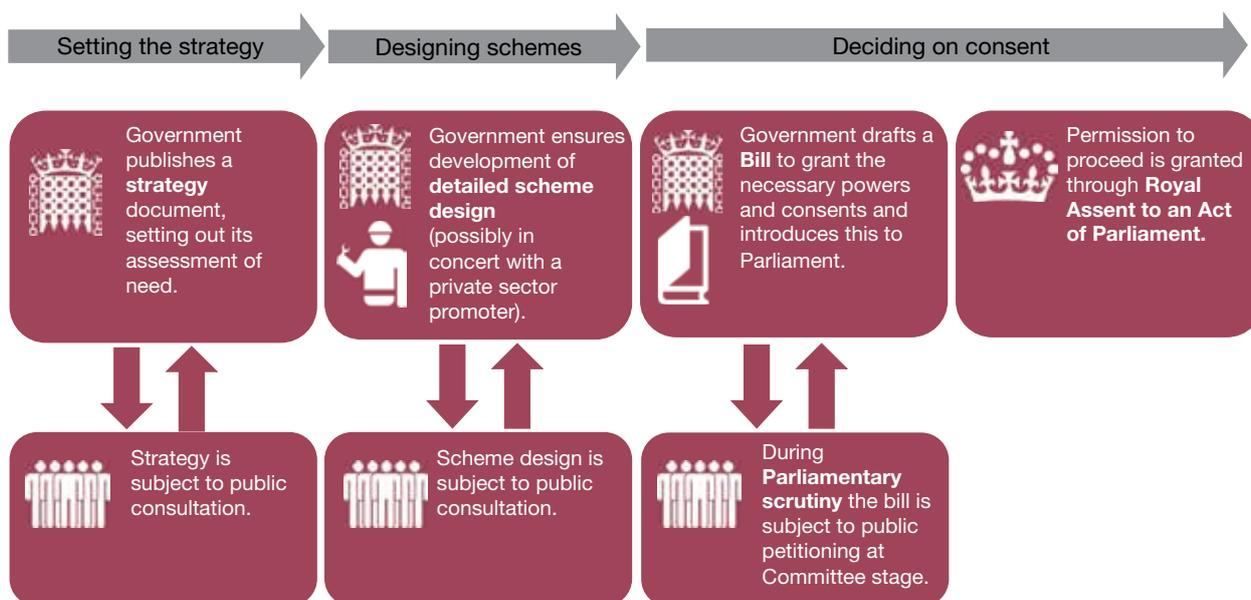
Figure 16.3: Hybrid bill planning process

16.24 As a consequence, any route to planning consent following this report will necessarily take some years to complete and will include significant opportunity for further public scrutiny of the proposed scheme, including its environmental impacts. The Government will need to take an early decision as to which option gives the greatest certainty and best enables the airport to attract the required investment and deliver the new capacity by 2030.

16.25 The road map at **Figure 16.1** sets out a very broad assessment of the time taken to achieve planning consent via either route. This assessment is sensitive to a number of factors:

- Under the NPS/DCO route a scheme promoter may be willing to do work ahead of the publication of an NPS, bringing forward the completion date. There would be no procedural impediment to scheme development being advanced in parallel with the Government's own work on a NPS. The preparatory work that Heathrow Airport Ltd has carried out as part of the Commission's own process may also help to accelerate this process.
- Airport capacity is a contentious issue and the privatised UK aviation market a competitive one. These factors make challenge or judicial review of Government decisions in this area likely. The Commission has noted recent Government work to reduce the time taken by the judicial review process, including the introduction of specialist planning courts. Given the sovereignty of Parliament, a Hybrid Bill, particularly once granted Royal Assent, would not be subject to legal challenge to the same degree.

- Although there is no set timescale beforehand, once an application has been accepted by the Planning Inspectorate as part of the DCO process it is subject to statutory timescales that require a Secretary of State decision within 12 months. The Parliamentary calendar for a Hybrid Bill is harder to predict. Recent examples suggest that a Hybrid Bill may take longer to complete but its potential, particularly once past second reading, to carry over between parliaments may provide more certainty in the longer term. Before deciding on whether to proceed with a Hybrid Bill, the Government will need to consider Parliament's capacity to deal with another Hybrid Bill alongside any that are required to progress HS2. For example, the Government could consider asking Parliament whether a Joint Committee of each House rather than two separate committees could be established to consider petitions against individual Bills and, in the light of recent developments in the Scottish Parliament, whether greater technical and specialist support could be given to Hybrid Bill committees.
- 16.26** In terms of overall timing and public scrutiny, therefore, the Commission does not see significant differences between the two approaches. While both routes have been used successfully to deliver major infrastructure projects, neither approach has been used in recent history to deliver airport expansion, so there is no clear precedent to follow.
- 16.27** The Commission has noted Heathrow Airport Ltd's preference for a NPS/DCO route and recognises that this option would leave the greatest control over how and when to bring forward a scheme in the hands of the airport operator. It has also noted that the flexibilities inherent within a Hybrid Bill would enable Government to take more wide-ranging powers to coordinate and ensure that different elements such as road and rail links and compensation and mitigation schemes come together to deliver new capacity most effectively.
- 16.28** Ultimately the decision on planning route is one that should form part of a wider discussion between the airport and the Government on how the scheme should be taken forward. The Commission does not believe it is necessary or helpful for it to make a firm recommendation.
- 16.29** In preparation for the planning process, the private sector promoter will want to engage with communities, local authorities and other stakeholders including airlines as it finalises its masterplan, and will want to give due consideration to measures that will mitigate the social and environmental impacts of construction.

Surface access

- 16.30** To conduct surface access appraisals, it was necessary to form a view of what the UK's surface transport networks might look like by 2030, with an emphasis upon London and the South East. Transport schemes which already have firm planning and funding commitments in place, including major projects such as Crossrail, HS2 and the Thameslink Programme, were included within a core baseline. In addition, the Commission sought advice from Network Rail, the Highways Agency, Transport for London and the Department for Transport regarding their views on the likely priorities for surface transport investment and the specific additional schemes that might be delivered before 2030. On the basis of these representations, it formed a view on its extended baseline.
- 16.31** The extended baseline represents one possible view of 2030 surface transport networks. There is no guarantee that all of the road and rail projects within the extended baseline will be delivered by 2030 and, in some cases, the surface access analysis undertaken found that particular projects had little or no impact upon the effectiveness of the airport's surface access package (for example, the most expensive project within the extended baseline, Crossrail 2, has only marginal impacts on all of the shortlisted schemes).
- 16.32** Nonetheless, while the precise package of surface access improvements required to allow schemes to meet their objectives may be different from that which was assessed by the Commission, investments of equivalent nature and scale would be necessary in order to alleviate issues surrounding mode share, access times, congestion (on rail, strategic and local roads) and air quality.
- 16.33** The Government will therefore need to agree the nature, scale and financing of the surface transport improvements associated with expansion. As part of this process, it would be appropriate for Government to seek contributions from the scheme promoter, both for schemes specific to the expansion proposal and for some of the schemes within the extended baseline. A contribution to works from the airport and its airline community would demonstrate a recognition of the benefits that those businesses were deriving from surface transport investments. Government should enter into these negotiations with the intention of securing the best deal for the taxpayer while complying with European rules on State aids. The commercial analysis undertaken suggests that the airport should be able to take on a significant proportion, if not all, of the surface access costs directly associated with expansion.

16.34 The Government will need to ensure that it is in a position to begin the planning and implementation of necessary surface access works at the appropriate juncture. This will involve aligning work on the specification of Control Period 6 and 7 outputs for the railway and rail franchises, the planning of investment in the strategic road network and work with appropriate local authorities on the funding and delivery of local transport improvements. A Joint Oversight Board could play a critical role here.

Airspace change

16.35 The delivery of any new runway would require substantial changes to London's airspace structures, including changes to flight paths for other airports within the system. This is a challenging process but can be completed efficiently within the required timeframes, given a clear direction and strategy from the Government including on how to consult more effectively with communities.

16.36 As set out in the *Interim Report*, modernisation of airspace structures in the South East to accommodate increasing traffic and take advantage of new technologies is required regardless of the Government's decision on additional airport capacity. It is disappointing that more progress has not been made in the last Parliament and renewed engagement from the Government will be required in this one.

16.37 Airspace redesign will need to be considered in the light of the Government's decision on airport expansion and the Government will need to consider how best to take forward this process. For the purposes of its appraisals, the Commission worked with scheme promoters and NATS to develop an indicative set of airspace designs to accompany each scheme. These indicative designs were constructed so as to be technically feasible and to allow for an objective comparison between the noise and other impacts of schemes, based on a common set of assumptions. The airspace designs used for the Commission's appraisal have not, however, been subject to detailed optimisation nor have they been developed on the basis of public consultation. Therefore they are not necessarily reflective of the final designs that will operate should the scheme be delivered.

16.38 Along with the position of the runway infrastructure, the designation of aircraft approach and departure routes is one of the key factors in identifying the number of people affected by an airport's noise impacts. Airspace design should therefore include significant involvement from local communities. There will need to be a process of design, consultation, refinement and safety assurance, with final airspace designs likely to be produced very shortly before the opening date of a new runway.

16.39 To facilitate the airport planning consent and delivery process, the Government and the airport may wish to agree broad commitments to communities at earlier stages in the process (for example on the provision of predictable respite). In that way, clear parameters could be established within which the design of specific airspace structures could take place. An independent aviation noise authority and dedicated Community Engagement Board could help to ensure that this process is inclusive and transparent. The Commission would expect detailed airspace designs to be agreed and safety-assured, following a final round of consultation, approximately 12 months before the opening date of the new runway.

Making best use of existing infrastructure

16.40 Irrespective of how the Government responds to the recommendations set out in this report a new runway will not open for at least 10 years. It is imperative that the UK continues to grow its domestic and international connectivity in this period, and this will require the more intensive utilisation of existing airports other than Heathrow and Gatwick.

Other UK airports

16.41 The capacity constraints at Heathrow and Gatwick present an opportunity for other UK airports in the coming decade. This is particularly true for the largest airports, which benefit already from high passenger numbers and large route networks, as well as the airports whose passenger catchments overlap most fully with those of Heathrow and Gatwick. There are encouraging signs that this opportunity is being seized, with a number of the UK's largest airports either maintaining or growing their passenger numbers and route networks during the challenging conditions following the financial crisis.

16.42 Crucially, this includes the addition and strengthening of long-haul connections. Last year Manchester served 43 regular long-haul destinations, including 15 to North America, and also launched a new service to Hong Kong. In the same year Birmingham served 15 regular long-haul services, including flights to Delhi, and also commenced a new service to Beijing (making it the first airport outside of the South East to offer flights to mainland China). The airport also extended its runway, enhancing its ability to cater for larger planes and more long-haul routes in the future. Since 2005, Edinburgh Airport has doubled and Newcastle Airport has tripled the numbers of passenger movements on regular long-haul services, and all of the UK's largest regional airports have seen growth of 9% or more against this measure.

- 16.43** As the economy has returned to growth, signs are emerging that these trends are accelerating. The last 12 months have seen UK regional airports develop new services to the Far East and destinations across North and Central America, including multiple new services to New York. A number of existing long-haul services have increased in frequency – including services to Delhi, Doha, Dubai and Toronto and some new long-haul routes are also anticipated. Regional airports are predicted to continue to grow their portfolio of long-haul connections in the coming decade, and the onset of the new generation of more fuel efficient aircraft will intensify this trend. As the international connectivity of these airports improve, more short-haul services can be expected to be drawn to them, in turn stimulating further increases in long-haul services.
- 16.44** For these reasons, although any long-haul growth is likely to remain focused on thick routes, with minimal, if any, dependence on transfer traffic, rather than on establishing connections to more marginal destinations, a number of the UK's regional airports will play an important role in enhancing or maintaining the country's connectivity in the coming decade. In *Discussion Paper 6: Utilisation of the UK's Existing Capacity*, the Commission considered what potential obstacles could prevent these airports from facilitating connectivity in the manner anticipated, and what measures could be put in place to overcome these obstacles. Responses to this paper emphasised the effectiveness of a number of Government measures, such as establishing enterprise zones in the environs of airports, and strengthening partnerships between airports, LEPs, tourism organisations and local authorities, at supporting regional airports. A number of airports communicated their desire for improvements to their surface access, and submitted responses highlighting the importance of these links.
- 16.45** The Commission made a number of specific recommendations in this area in its *Interim Report*. In addition, it recommends that both national and local government recognise the crucial importance that regional airports will play in growing the nation's connectivity and economy in the coming decade, and takes this into account in future policy and planning decisions that pertain to those airports.

Other London airports

- 16.46** The other airports in the London system are developing business strategies to make best use of their capacity, and the government, and other stakeholders, could support them in doing so. The Commission set out a number of recommendations in this area in its *Interim Report*, and it has continued to keep this issue under consideration, including through its *Discussion Paper 6: Utilisation of the UK's*

Existing Capacity. Its assessment of a number of further possible strategies for the development of the airports within the London system is set out below.

- 16.47 Stansted Airport:** Stansted has recently begun an £80 million terminal redevelopment to improve the airport facilities and offer airlines a more tailored and differentiated airport product. The airport aims to grow its mix of airlines, attracting both short-haul and long-haul full service, and the volume of extra capacity currently available at Stansted will be key to the wider London airports system in the years before any new runway is operational. The Commission therefore welcomes the renewed focus on the needs of airport users travelling by rail to Stansted, and to Southend, in the consultation on the West Anglia Route Study.
- 16.48** The airport's owner, Manchester Airport Group (MAG), has a long-term aim to secure the lifting of the current planning cap of 35 million passengers a year, and in 2014 Stansted Airport held a consultation on its Sustainable Development Plan which sets out how the airport believes it can develop its single runway to a capacity of around 40-45 million passengers a year within pre-existing environmental limits on noise and air transport movements. Planning caps are valued by communities close to airports as they provide a control on negative impacts that is not open to amendment without an extensive consultation process and the adjudication of a body independent of the airport (the planning authority). The Commission supports the need to ensure local people are secure in having appropriate levels of protection from unacceptable negative impacts of living close to an airport, but also recognises the strategic importance of Stansted Airport to the wider London airport system.
- 16.49** The Commission considers that there may be a case for reviewing the Stansted planning cap if and when the airport moves closer to full capacity. Its forecasts indicate that this would not occur until at least the 2030s, although the airport has seen rapid growth since its purchase by MAG, which if sustained over a longer period would bring this forward. The Commission does not have any view as to the outcome of any such review, but is clear that it should be carried out on the basis of a full detailed assessment and consultation process, taking into consideration the environmental and other issues that supported the imposition of the original cap, as would be expected for any planning application of this nature and scale. The independent aviation noise authority could be involved in such a review.
- 16.50 City Airport:** The recent planning application for the City Airport Development Programme (an extended terminal, a new taxi-way and additional parking stands for larger aircraft), which was supported by Newham Council, has been refused by the Mayor of London due to its possible noise impacts. This means that as things stand

London City Airport would be limited in its ability to contribute further to improving long-haul connectivity. The development programme would have brought the eastern seaboard of the USA and Middle Eastern destinations within the range of direct flights from the airport (the current JFK flight requires a stop in Shannon on the flight out).

- 16.51** In the absence of this new development two key opportunities for London City Airport in the coming years will be the Custom House Crossrail station – which will provide faster travel times (via a Docklands Light Railway (DLR) connection) to the airport from the West – and the new Royal Albert Docks development, a planned new business district due to deliver over 3.2 million square feet of work, retail and leisure space, including 2.5 million square feet of prime office space into the airport’s immediate catchment.
- 16.52** The Commission expects London City Airport to take advantage of these opportunities, while taking into account the needs of its local residents, to reinforce the airport’s valuable connectivity and specialist business travel provision for London.
- 16.53 Luton Airport:** A recent planning application approval at Luton Airport will allow it to achieve a capacity of 18 million passengers per year by 2025 and deliver an improved passenger experience. The airport is also developing plans to improve the connection to the Luton Parkway station. The Commission supports the ongoing discussions between Luton Airport and Govia Thameslink Railway Ltd (the new operator of the Thameslink Rail Franchise that serves the airport) on how to develop the current rail service. The agreed western section of East-West rail could also support rail journeys (via a change at Bedford) between Luton Airport and local centres such as Milton Keynes and Oxford.
- 16.54 Southend Airport:** London Southend Airport has developed extensively since it was acquired by the Stobart group. Commercial agreements with low-cost airlines such as easyJet are expanding the route network, in particular to secondary business and leisure destinations in Europe. The Crossrail scheme will present new opportunities for the airport, as it will connect its current terminal at Liverpool Street station to a wider London catchment. While there are no immediate plans for new developments on the London-Southend train route, Network Rail has recognised, in its West Anglia Route Study consultation, that there will be significant growth at Southend Airport, and proposed developments in Control Period 5 that could support this. The Commission is pleased to see the consultation on the West Anglia Route Study taking in to account the future growth of the airport.

16.55 The re-tendering of the Abelio Greater Anglia Franchise in 2016 could also be an opportunity to support the airport's aims of updating rolling stock and securing more early and late services to support airport users. The Commission also welcomes the focus in the London Southend Airport Joint Area Action Plan on local road improvements that would support the airport and develop local business parks.

Second additional runway

16.56 Even with a third runway at Heathrow, capacity in the London and South East system could be highly constrained by the 2040s and, as the Commission noted in its *Interim Report*, there would be likely to be sufficient demand to justify a second additional runway by 2050 or, in some scenarios, earlier.

16.57 That does not necessarily mean, however, that a second new runway would be justified on economic or environmental grounds. In particular, it will be crucial for Government and the aviation industry to work together to drive technological improvement in the sector and deliver significant progress in agreeing an international framework to tackle emissions, if further expansion is not to materially affect the UK's ability to meet its current and future climate obligations

16.58 The Airports Commission is a one-off independent Commission with defined terms of reference. It has followed an integrated and collaborative approach, seeking throughout to generate a greater consensus on airports policy. The Commission believes that these factors have been key to it achieving a comprehensive evidence base from which to make a coherent and transparent recommendation. It would support future decisions on the topic of airport capacity being undertaken in a similarly independent manner, taking into account the full range of environmental, social, economic and strategic factors, as well as operational and commercial viability.

16.59 Given the lengthy planning, decision-making and construction timescales for major infrastructure projects, it would be appropriate to begin this process earlier rather than later. Nonetheless, it would be premature for any decision to be taken about the location or type of capacity needed before an evaluation could be made of the impacts of the new runway at Heathrow, as well as of the development of the airline industry's business models, the UK's overall infrastructure and connectivity needs and those of its nations and regions, and the broader policy context.

- 16.60** The need to reduce greenhouse gas emissions, including the UK's legislated targets in this area, would be highly relevant and the case for new capacity would need to be closely scrutinized in the light of climate-change policy. Without strong action by Government and industry to reduce emissions from aviation, a second additional runway would increase the challenge of achieving the CCC's current planning assumption, if delivered before 2050, as well as any longer-term climate obligations.
- 16.61** If a view were reached that new capacity was necessary and feasible, then a wide range of options should be considered. This could include new or revised proposals at locations considered as part of the Commission process, for example at Stansted or Gatwick, as well as options driven by growth outside London and the South East, such as expanding Birmingham or Manchester Airports. The Commission does not however believe that there is any credible operational or environmental case for a fourth runway at Heathrow and has recommended that the Government take steps to rule this out in Parliament.

Conclusion

- 16.62** Whilst each of the three schemes shortlisted for detailed consideration was considered a credible option for expansion, the Commission has unanimously concluded that the proposal for a new northwest runway at Heathrow Airport, in combination with the significant package of measures to address its environmental and community impacts, and enhance its regional benefits, discussed in **Chapters 14** and **15**, and summarised in the table below, presents the strongest case.
- 16.63** This proposal would deliver more substantial economic and strategic benefits than any other shortlisted option, strengthening connectivity for passengers and freight users and boosting the productivity of the UK economy. The package as a whole strikes a fair balance between national, regional and local priorities. And it is the most effective means of achieving the goal set in the Commission's original terms of reference to maintain the UK's position as a global hub for aviation.
- 16.64** The primary responsibility for delivering the new runway is expected to lie with the private sector scheme promoter. Nevertheless, there are a number of processes which will require central Government and other bodies to play an important enabling role, and the Commission's recommendations for ensuring this process is an expeditious as possible are summarised below.

Table 16.1: The Commission’s wider recommendations

Limiting the impacts of noise
<ul style="list-style-type: none"> • Clear noise performance targets (a noise envelope) should be agreed and Heathrow Airport Ltd (HAL) must be legally bound to stay within these limits. • A third runway would create the opportunity to end night flights before 6:00am. This opportunity should be taken. Following construction of a third runway at Heathrow there should be a ban on all scheduled night flights between 11:30pm and 6:00am. • A third runway should allow periods of predictable respite to be more reliably maintained. HAL should work with local communities to determine how respite should best be provided.
Improving compensation
<ul style="list-style-type: none"> • HAL should honour the commitment it has made to compensate those who would lose their homes at full unblighted market value plus an additional 25% and reasonable costs and it should make this offer available as soon as possible. • HAL should engage with local businesses to ensure that they are fairly compensated for any disruption. • A Community Engagement Board may act as advocate for potentially displaced residents and businesses who are concerned about the offer available to them and provide help and advice. • HAL’s offer to purchase residential property within a wider area at the same rate is a positive step and should be made available for those who wish to take it up. Re-letting or reselling of any such properties should be sensitive to the needs of the wider community. • HAL should work with Government and local communities to determine appropriate support for those who may face exceptional hardship if they are unable to move because of uncertainty over expansion. • HAL’s proposal to spend more than £1 billion on community compensation, including £700 million on noise insulation is welcome. HAL should be held to this commitment.

- The wider community package should include significant levels of investment in noise insulation and other support for schools as a priority.
- HAL should also be prepared to go further if it is to demonstrate a genuine commitment to a world-class compensation package that matches the scale of its business ambitions. This should include working more collaboratively with local communities to identify priorities for compensation and supporting efforts to ensure that those who benefit from expansion also make a fuller contribution to compensating those who endure the noise and other consequences.
- The Government should introduce a noise levy or charge at major UK airports to ensure that airport users pay more to compensate local communities. A levy should not impose undue or unfair costs at any airport.
- Air Passenger Duty is an important feature of a sustainable aviation sector in which those benefiting directly make a contribution to wider society benefits.
- Increased business rates revenue from airport expansion should be retained locally and distributed fairly across impacted areas.

Helping local economies to thrive

- Airport expansion will support thousands of new jobs. HAL should work with local authorities and schools to ensure local people, including young people, are able to benefit from this opportunity and should support the London Living Wage.
- Growth in jobs could increase demand for local housing and related community infrastructure. HAL should build on existing commitments to support sustainable development of communities over several years. Local planning authorities should support sustainable development through more integrated joint planning across boundaries.
- HAL should be held to performance targets to increase the percentage of employees and passengers accessing the airport by public transport, reducing pressure on local roads and air quality.
- The introduction of a congestion or access charge scheme should be considered to help ensure that road traffic to and from the airport does not cause unacceptable impacts on local air quality or road congestion.

Listening to local people

- A new Community Engagement Board with real influence over spending on compensation and community support and over the airport's operations should be set up under an independent chair, drawing on the models successfully in operation at Schiphol and Frankfurt Airports.
- An independent aviation noise authority should be established with a statutory right to be consulted on flight paths and other operating procedures. The authority should act as an impartial source of expert advice, enabling all sides to engage more meaningfully on this complex and subjective issue.

Providing legal reassurance

- HAL should be legally bound to deliver on the promises that it makes to local communities. There should be clear independent monitoring of performance against commitments and appropriate means of redress.
- Additional operations at an expanded Heathrow must be contingent on acceptable performance on air quality. New capacity should only be released when it is clear that air quality at sites around the airport will not delay compliance with EU limits.
- The Government should make a firm commitment in Parliament to rule out any fourth runway at Heathrow. This may be as part of a National Policy Statement or through legislation.

Addressing regional priorities

- The Government should alter its guidance to allow the introduction of Public Service Obligations on an airport-to-airport basis and should use them to support a widespread network of domestic routes at the expanded airport.
- HAL should implement additional measures to enhance regional connectivity, including introducing reduced charges and start-up funding for regional services.

Next steps

- A timely decision by Government on the Commission's recommendations will greatly facilitate the expeditious delivery of new capacity.
- All parties involved in delivering the runway should agree clear roles and responsibilities. Risks to both the private and public sector should be identified and monitored and responsibility for managing different risks clearly allocated and defined. It may be appropriate to set up a Joint Oversight Board to facilitate this.
- A stable and predictable economic regulatory environment will be important to help ensure the most efficient financing arrangements for the scheme. Early engagement between the airport, airlines and the CAA, as well as Government will be beneficial.
- Under current market conditions, supportive measures from the Government such as the provision of guarantees are unlikely to be required. However, ongoing monitoring of the situation will be appropriate.
- Expansion will have impacts far beyond the airport boundary. Successful delivery will require consideration of how the different work-strands interact. The Government should consider establishing a dedicated body to ensure the efficient delivery of a project of this technical and political complexity.
- The Government may wish to deposit a 'Paving Bill' or table a motion in Parliament to set out its early commitment to considering the Commission's recommendations and delivering policies that would support regional and community interests in the event of expansion.
- A decision on planning route should form part of a wider discussion between the airport and the Government on how the scheme should be taken forward.
- The Government will need to agree the nature, scale and financing of the surface transport improvements associated with expansion. It would be appropriate for Government to seek funding contributions from the scheme promoter.
- The delivery of any new runway would require substantial changes to London's airspace structures. This can be completed efficiently, given a clear direction and strategy and renewed engagement from the Government.
- The need to make best use of existing infrastructure will remain. This will mean opportunities for airports within the London and South East and across the country.

Annex A – The Commission’s Expert Advisory Panel

Introduction

The Commission established an Expert Advisory Panel to help it access, interpret and understand the evidence base for its work. The membership and terms of reference of the panel are provided below.

While the work of the panel made a valuable contribution to the Commission’s work, the views expressed and conclusions reached in this report are those of the Commission and do not necessarily reflect opinions of any other parties who have contributed to gathering and scrutinizing of the evidence base.

Expert Advisory Panel: Terms of reference

Purpose

The function of the Expert Advisory Panel is to help the Airports Commission to access, interpret and understand evidence¹⁰⁵ relating to the Commission’s work, and to make judgements about its relevance, potential and application. The Panel is strictly an advisory body, and has no executive powers.

Terms of reference

The terms of reference for the Expert Advisory Panel are to advise the Airports Commission on a range of issues including (but not limited to) economics, climate change, aircraft noise, air quality, aviation technology, and engineering, and in particular to:

- act as a sounding board on scientific, economic and technical issues relevant to the Commission’s work;
- expose the Commission to the full range of views on issues relating to the Commission’s work;
- advise on the quality, limitations and appropriate uses of research carried out by, or on behalf of, the Commission;

105 ‘Evidence’ in this context covers scientific, economic and technical issues that may have a bearing on the Commission’s work.

- advise on specific points from proposals on airport capacity where evidence is limited or further work is required;
- advise on specific issues and problems referred to it;
- help the Commission, where requested, to develop and maintain links with the external research community and industry experts; and
- provide research papers or presentations where requested by the Commission.

Given the range of issues that will have a bearing on the Commission's work, the Expert Advisory Panel may need to convene smaller, more specialist, working groups to examine specific issues, drawing on external expertise where appropriate. This will be by agreement with the Chair of the Airports Commission.

Expert Advisory Panel: Membership

Professor Helen ApSimon

Mr Ian Brown CBE FCILT

Dr Charlotte Clark BSc (Hons) PhD CPsychol

Mr Richard Leslie Everitt

Professor Piers Forster

Mr Robert Jennings CBE

Rory Joyce BA (Hons) MSc CEnv FRICS MRTPI FRGS AoU

Dr Andrew Kempton CEng FRAeS

Professor Peter Mackie

Mr Gordon McKechnie

Professor Andrew McNaughton FREng

Mr Paul Morrell

Mr James Neal

Professor Henry Overman BSc (Bristol) Msc (LSE) PhD (LSE) AcSS FRSA

Mr George Paulson FCILT, FRAeS

Mr Brian Pearce

Dr David Quarmby CBE MA PhD Hon DEng Hon DSc FCILT FCIHT FTS CORS

Professor Andreas Schäfer

Professor Keith P Shine FRS

Mr David Starkie

Mr Starkie stood down from the Expert Panel in December 2014

Professor Callum Thomas PhD ARCS FRAeS